

# AMIGA

ISSUE 26 ■ SEPTEMBER 1991 ■ £2.95

## FORMAT

### DELUXE PAINT IV EXCLUSIVE

This year's big release,  
but how good is it?  
Find out here first!

**TRY IT YOURSELF!**  
Paint in 4096 colours with our  
exclusive Coverdisk demo!

COVER DISK  
**26**

**Deluxe Paint IV**

Create your own 4,096-colour pictures with this exclusive demo of the new version of the world-beating art package – the most eagerly awaited non-game release in years.



**Making Music with the Bitmaps**  
We give you the samples, the backing track, the music program and all the advice you need – so you can create your own stereo game music.



**Magic Pockets**  
Play this special level of the Bitmap Brothers' latest Renegade release. Stuff your pockets with toys, frolic over fun-packed platforms.

**AMIGA FORMAT**

### GET INTO THE GROOVE!

- Want to know how the music for games is made? The Bitmaps sell their secrets.
- Want to do it yourself? We give you everything you need to start making music.

**NO COVERDISK?**

THEN ASK FOR ONE FROM YOUR NEWSAGENT

**PLAY the amazing Magic Pockets!**



- GET THE POWER with Mega-lo-Mania ● POT BLACK in Jimmy White's Snooker ● FLY the Thunderhawk
- WANNA MAKE 3D GAMES? New AMOS in full 3D
- LOOK AT THAT! Stunning new graphics packages let you draw, create fractal worlds, work in 24-bit colour

10 unique pages of  
incredibly useful  
hints, tips and advice  
**Workbench p173**  
**Gamebusters p103**

# DARKMAN



**Peyton Westlake was left for dead... Darkman now lives.** With the ability to take on the appearance of anyone he chooses, he has sworn to avenge his would-be assassins whose evil exploits have left him hideously disfigured. Now you take on the role of **Darkman** - master the technology of his disguising system - enter the gang of mobster Robert G. Durant and conquer them from within. Live through all the high spots of the movie - the breathtaking helicopter fight sequence - the skyscraper shoot-out - dice with death as you are plunged, swinging into the heaving freeway traffic.

**Darkman lives... but not for long?!**

TM & © 1990 UNIVERSAL CITY STUDIOS, INC. ALL RIGHTS RESERVED. LICENSED BY MERCHANDISING CORPORATION OF AMERICA, INC. NOT AVAILABLE ON THE PC

**ATARI ST / CBM AMIGA  
IBM / AMSTRAD PC  
& COMPATIBLES**



The strangest the experience... the experience... **Elf**. Your magic tread deeper in castle guards, to get-smart can't but these riv cantankerous, creatures and your gnostic po game features Numerous secre help you with yo **your own ghost**



OCEAN SOFTWARE  
6 CENTRAL STREET  
TEL: 061 832 663



...en in fairy tales - but nothing so strange as  
 encounter on your travels as **Cornelius the**  
 cast many spells, increasing in power as you  
 stical lands of gooks and goblins. Even the  
 ings with the IQ of a cold-steel rivet, are on a  
 y may seem a little backward to start with,  
 ed, bovver-bullies will soon become  
 ies if you let them. Many weird, villainous  
 uzzles test your game-play technique and  
 can even control some of the background  
 ou to get to where you think you should be.  
 deep within the forest where vital clues can  
 out beware...  
**erialise to haunt you!**



...RE LIMITED  
 ...CHESTER • M2 5NS  
 ...AX: 061 834 0650

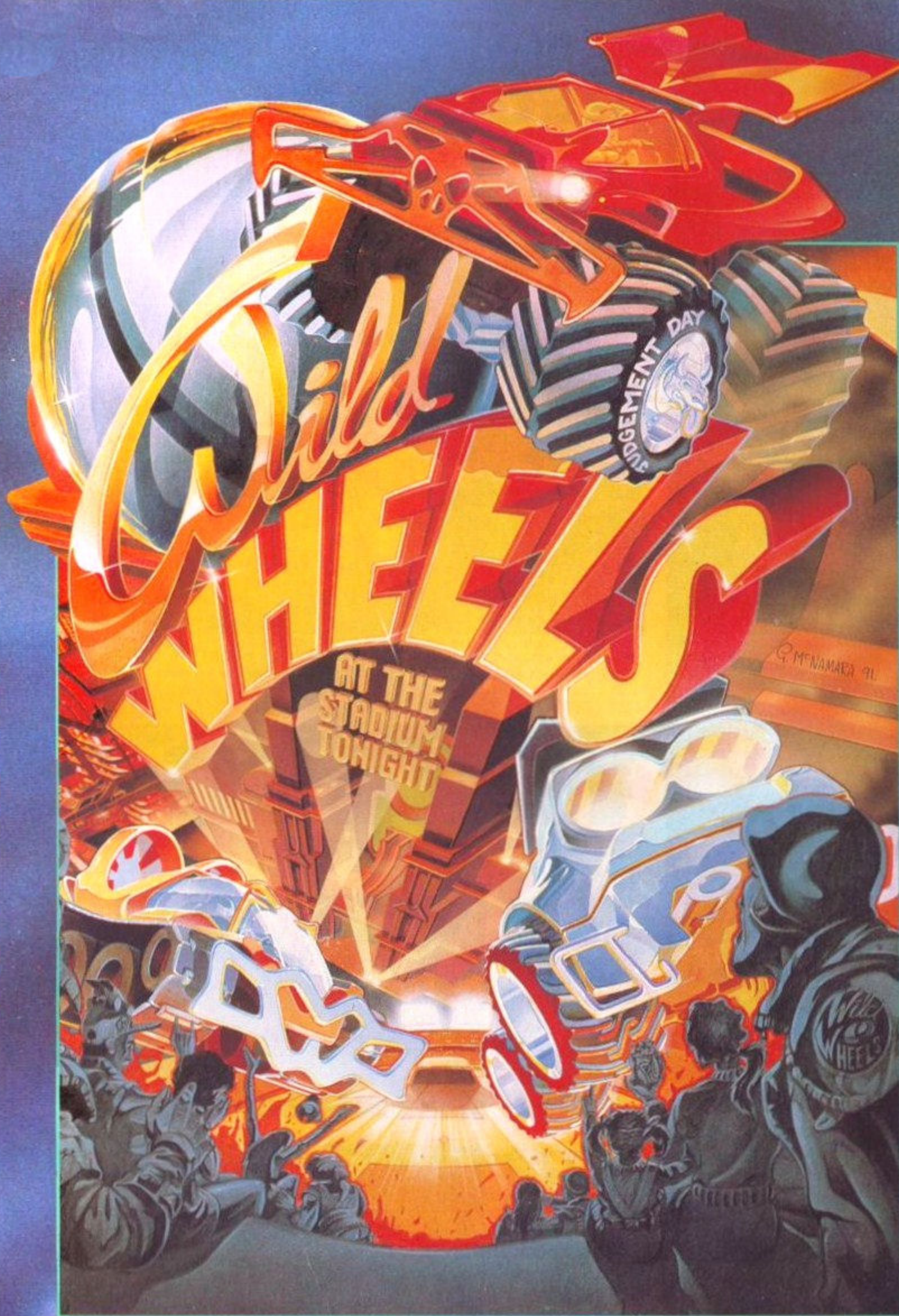

My head is thumpin', and my heart is pumping the adrenalin around every vessel of my hyper-tense body - the 'driving unit', that will be shoe-horned, wedged like a Colt 45 into its holster, as I am placed into the command seat of my vehicle - ready to enter the arena of play... and combat.

"Wild Wheels" they call us. Combatants who play a "game" - a game where there are two ways to lose... down on points or down on fuel - the fuel of life! And our "kit" for action are the finely honed masterpieces of engineering... machines that will pole-axe the opposition, melt them, crush them, detonate them into a million white-hot, speeding grains of shrapnel. The 'kit of death' where many of us will experience our last, final, blinding flash. Now, in the arena, the game becomes a struggle to win, a fight for life. The noise from the screaming crowd is drowned by the incessant roar of the mighty heart of this mechanoid beast, its engine pushing out every ounce of power to keep me just ahead, and delivering a heavy, sickening blow into my back as it accelerates at my command. Taking aim, I firm up every muscle ready for the great burst, the deafening scream as I unleash my lethal messenger... and its message - "GAME OVER!"

But that's just half the game story. Now YOU enter the arena... ENJOY THE SHOW!

**ATARI ST / CBM AMIGA**  
**IBM / AMSTRAD PC**  
**& COMPATIBLES**

**EDITORIAL DEPARTMENT**

**EDITOR** Damien Noonan  
Features and general enquiries

**SCREENPLAY EDITOR** Trenton Webb  
Games and entertainment software reviews

**REVIEWS EDITOR** Paul Lyons  
Serious hardware and software reviews

**TECHNICAL EDITOR** Pat McDonald  
Workbench, Coverdisk and technical enquiries

**STAFF WRITER** Maff Evans  
Gamebusters and games enquiries

**PRODUCTION EDITOR** Gary Lord  
Competition enquiries, copy contact

**ART DEPARTMENT**

**ART EDITOR** Marcus Dyson  
Design, photography and related matters

**DESIGNER** Frank Bartucca  
Making the pages look good!

**ADVERTISING DEPARTMENT**

**ADVERTISING MANAGER** Jennie Evans

**SENIOR SALES EXEC** Duncan Ferguson

**AD SALES EXEC** Jackie Garford  
Advertising sales, problems with advertisers

**ADVERTISING PRODUCTION** Fiona Milne  
Typesetting, ad layout, deadlines, ad film

**PROMOTIONS MANAGER** Michele Harris  
Coverdisk space/Competition arrangement

**CIRCULATION** Sue Hartley/Kate Hodges  
Trade deals and availability problems

**Amiga Format**

30 Monmouth street  
Bath, AVON, BA1 2BW

**Telephone** 0225 442244  
**Facsimile** 0225 446019

**SUBSCRIPTIONS DEPARTMENT**

If you read Amiga Format every month, why not make sure of your copy by getting it delivered straight to your door? See Page 178 of this issue for details!

**MAIL ORDER DEPARTMENT**

Take advantage of our mail order bargains. See the Special Offers details on Page 186!

**BACK ISSUES**

Turn to page 178 to find out how to get 'em!

**Amiga Format**

Subscriptions/Mail Order  
The Old Barn, Somerton,  
SOMERSET, TA11 7PY

**Telephone** 0458 74011  
**Facsimile** 0225 446019

© 1991  
**Future**  
PUBLISHING

We cannot accept liability for any mistakes or misprints. No part of this magazine may be reproduced in any form without our permission.

Quote of the month: "I've been forty years discovering that the queen of all colours is black."

Member of the Audit Bureau of Circulations.

Registered Circulation



**115,158**

Jan - June 1991

**REGULARS**

**News** 9  
Commodore announce the new Amiga 500 bundle

**Previews** 43  
What's on the way in games: Rodland and Utopia

**Gamebusters** 103  
Get a step ahead: Eye of the Beholder tipped to death

**PD Update** 153  
What's the best in the newest free software releases

**Workbench** 173  
More good advice than ever before for seekers of help

**Subscriptions** 178  
Make it easy for yourself: get your mag delivered!

**Special Offers** 186  
Check out a few of the special bargains on offer



Cartoon Classics, the new Amiga bundle, could be the best seller yet. Find out what's in it on Page 9.



Having problems stomping the spiders and cleansing the sewers in Eye of the Beholder? You need some Gamebusters hot help on Page 103!

**This month in**

**REVIEWS**

**AMOS 3D and Compiler** 114  
If you want to program your own games, check this! Create full 3D games, make stand-alone programs

**Design Works** 120  
Discover the easy route into print-perfect line art with the latest structured drawing software

**Art Department Professional** 124  
How to work in 24-bit colour on a standard Amiga... image processing grows up and leaves home

**GVP Combo Board** 132  
Get up to speed with a very fast accelerator that could be the answer to your ray-trace blues!

**Concept Keyboard** 137  
Simple control system for younger or less able hands: an exciting educational hardware release

**VistaPro** 140  
The sexiest graphics programs ever to hit your screen? Create realistic fractal landscapes in 24-bit colour

**TechnoSound Turbo** 147  
Catch the sounds with this revamped sampler, now featuring a sequencing system and MIDI support

**Mac and DOS to DOS** 149  
Talk to PCs and Macintoshes with these handy utilities that can read and write other computers' disks

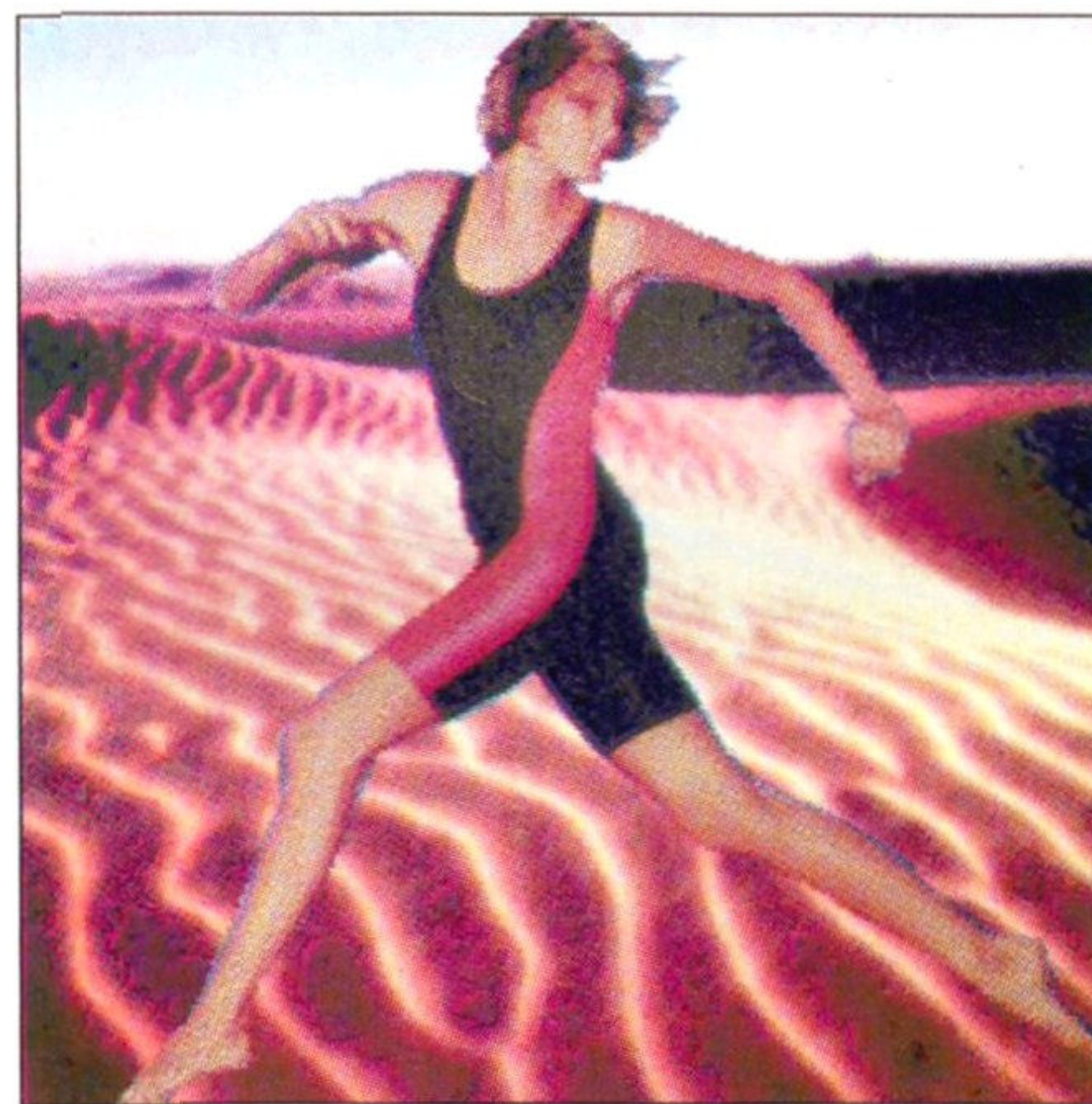

Cutting one image into another and doing it in full 24-bit colour is what makes Art Dept Pro special. See how well it does the job on Page 124.

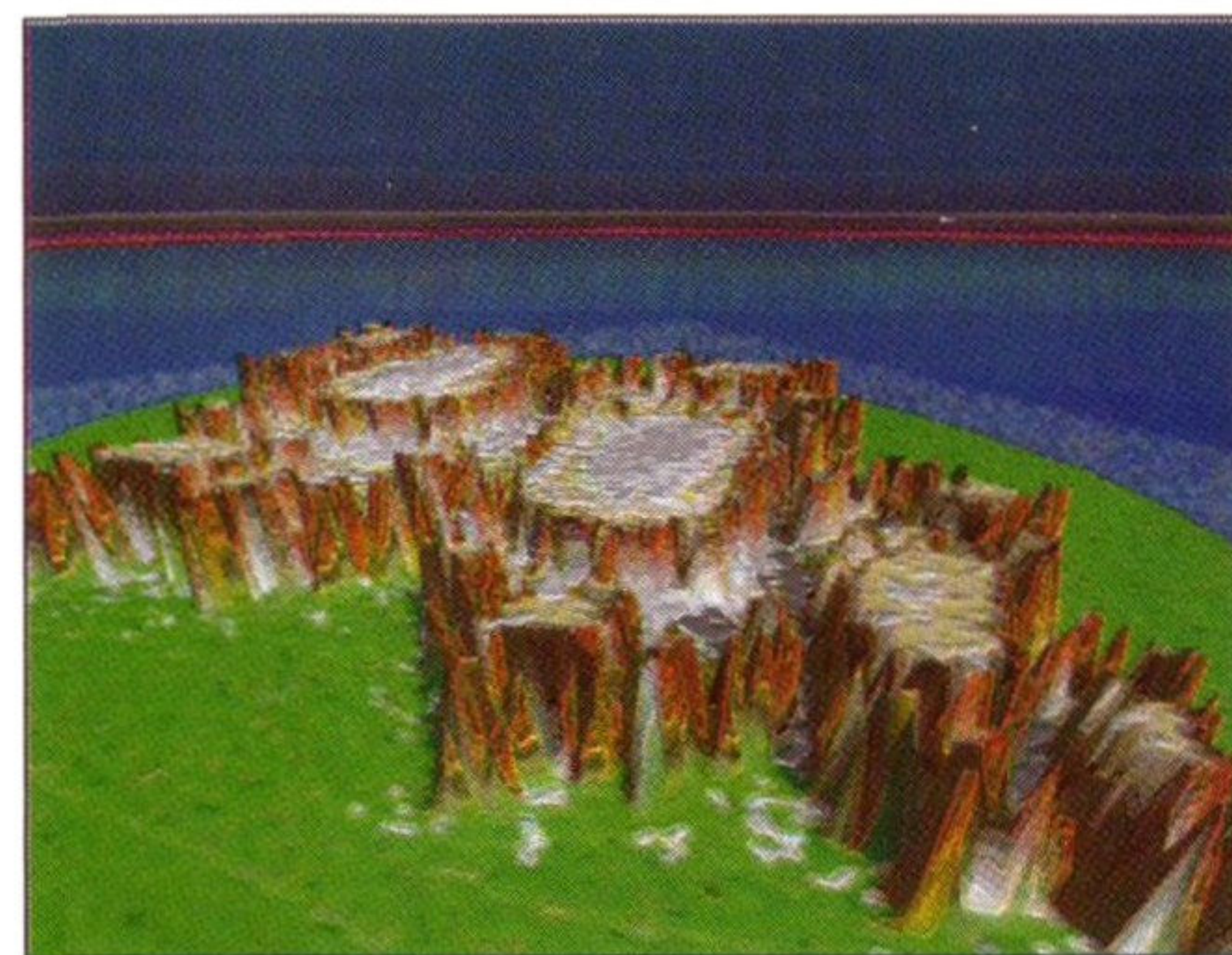

If you've ever wanted to make an imaginary landscape out of a Julia set, you're probably mad. If you don't want to after reading about VistaPro on Page 140, you're definitely mad!

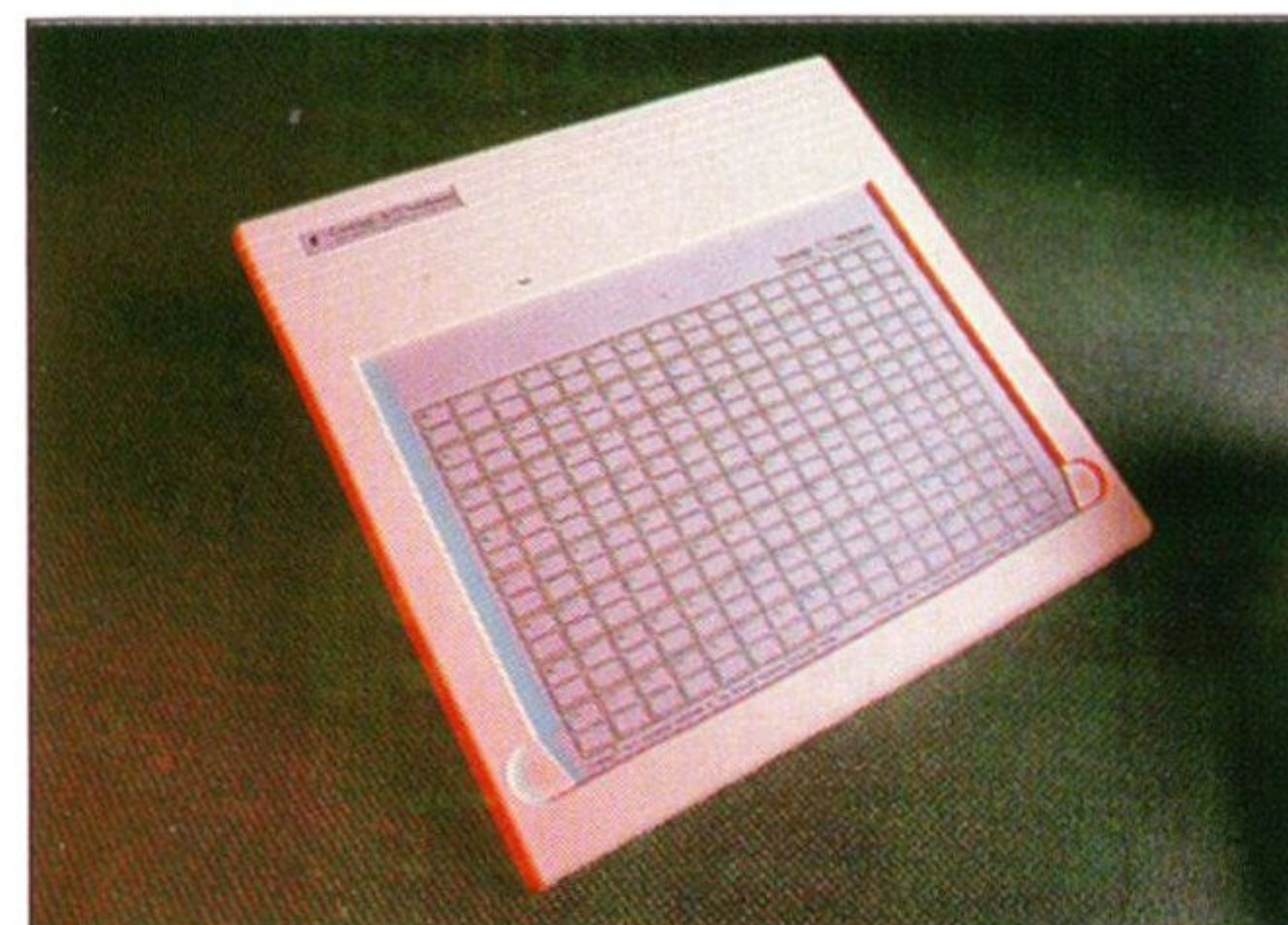

A unique idea: that's the Concept Keyboard, aimed at special needs and educational use but a very flexible piece of kit. Find out what it does on Page 137.

# SPECIALS

## Deluxe Paint IV

The year's most exciting release: but can it make the grade?

22

## Making Music With the Bitmaps

The secrets of in-game music revealed by the experts

31



Deluxe Paint IV not only brings 4096-colour HAM painting and animation, it can also still work with less. But is it any good at it?



If you've ever wondered how in-game music was made, we tell you: courtesy of the man who put Betty Boo's songs into Magic Pockets.

# AMIGA FORMAT

## SCREENPLAY

### FORMAT GOLDS

Mega-Lo-Mania	54
Jimmy White's Snooker	58
Thunderhawk	82

### REVIEWS

Atomino	61
Navy Seals	62
Bart Simpson vs the Spaceman	64
Llamatron	66
Sliders	68
Battle Chess II	71
Swap	72
Frenetic	76
Cardinal of the Kremlin	79
Challenge Golf	85
Hero Quest Data Disk	
Arcade Trivia Quiz	
Armalyte	
Charge of the Light Brigade	
Striker Manager	
Billiards II Simulator	
Stack Up	87



### MEGA-LO-MANIA

Taking on the top god games – and giving no quarter. Invent the atom bomb on Page 54.

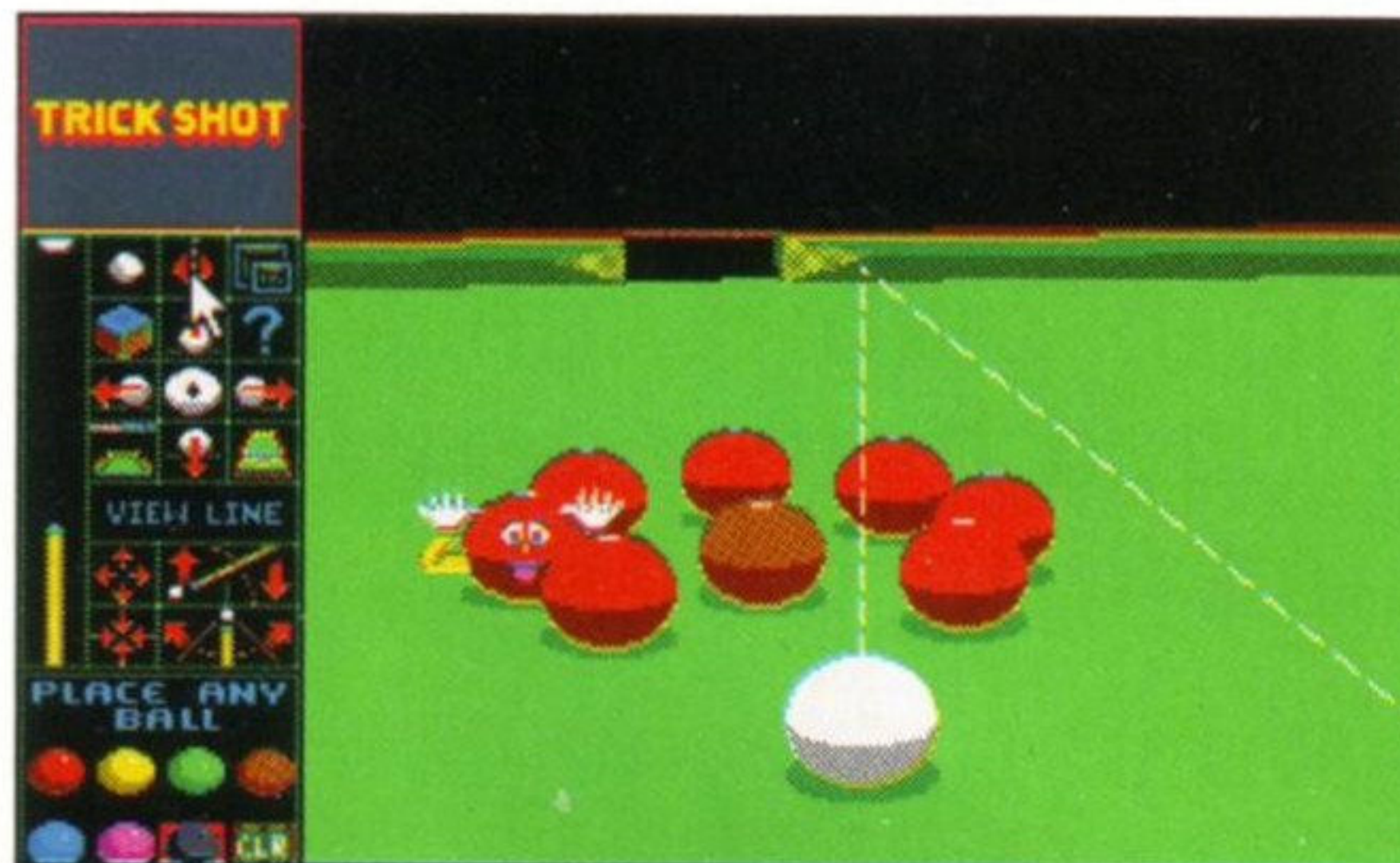

### JIMMY WHITE'S SNOOKER

Reap the whirlwind with a wicked 147 break on Page 58.



### THUNDERHAWK

How come flying a chopper is suddenly easier and more fun than falling off a log? Get airborne and keep your finger on the firebutton on Page 82.



### LLAMATRON

It's old-fashioned, it's obscenely garish, it's sickeningly noisy and it's more fun than fishing. Get weird on Page 66.

# COVER DISK p17

## Magic Pockets



You've seen it on telly, now try it yourself! As ever, we bring you the top games in playable demo form. Check out Renegade's amazing new platform romp and stuff your magic pockets with goodies.

## Making music with the Bitmaps

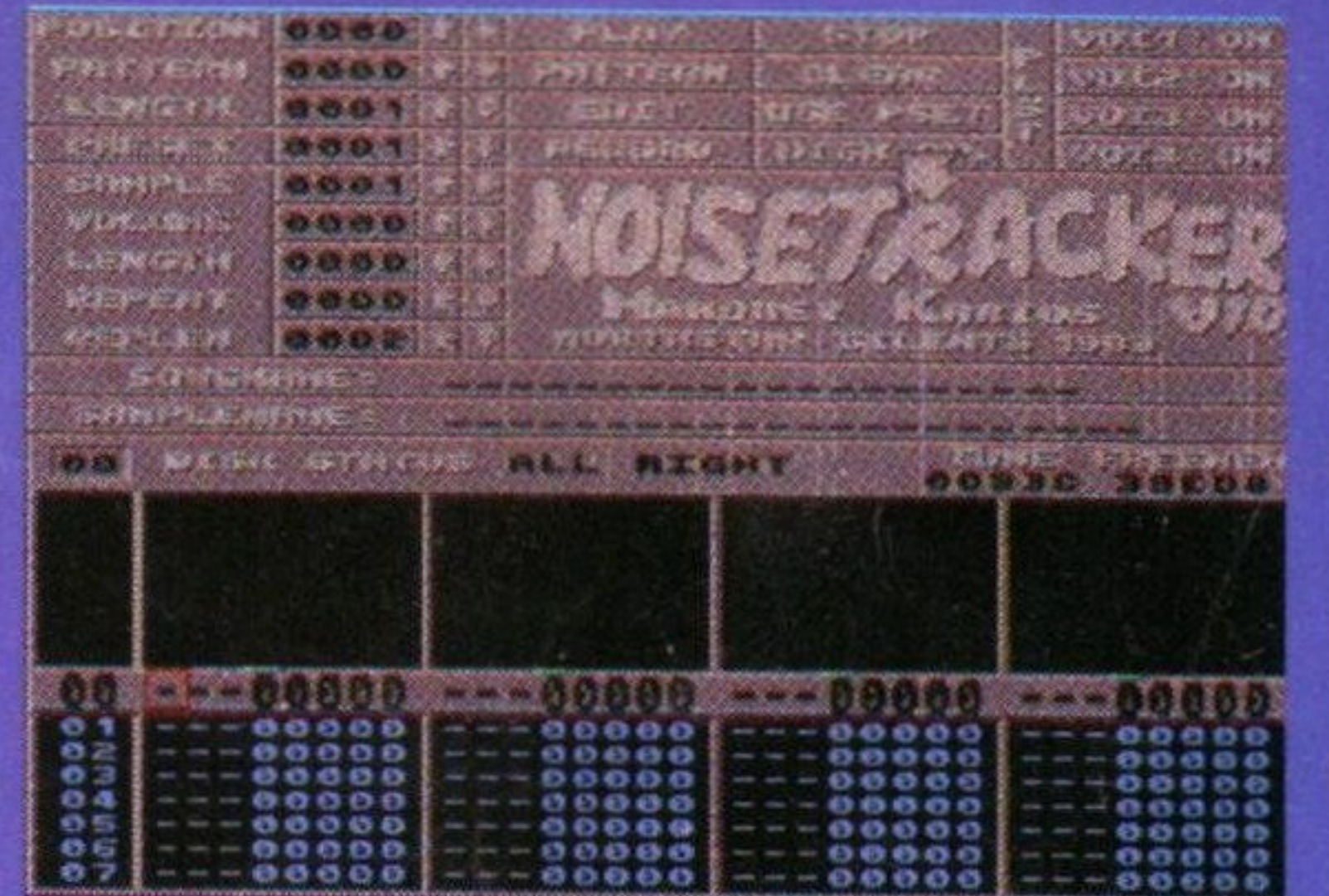

With the fabulous NoiseTracker and a heap of ready-made samples, there's everything you need to make your own tunes.

## DPaint IV

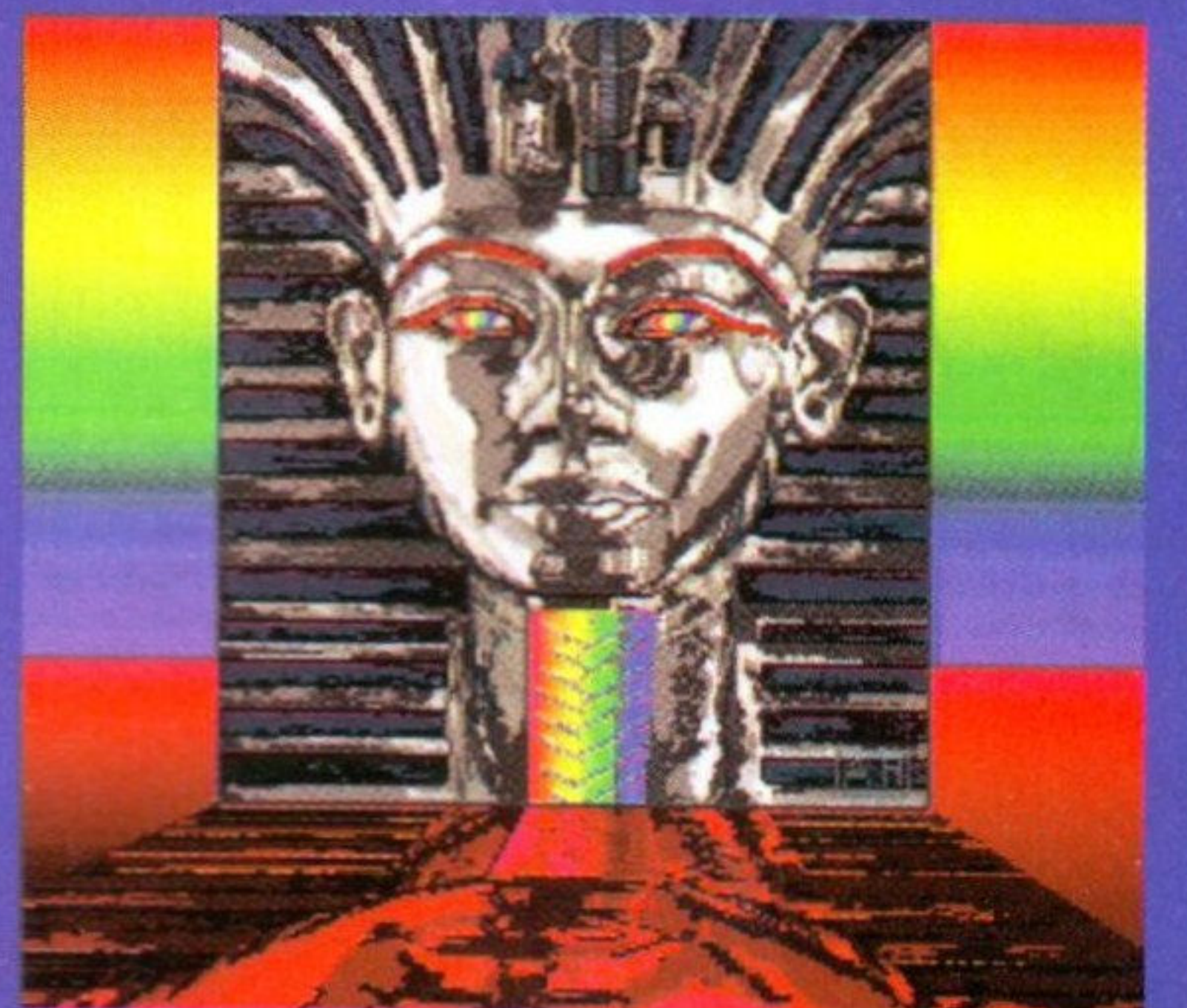

This is the big one! We bring you an exclusive demo of the year's biggest non-game release. Create your own 4,096-colour pictures with the amazing new HAM paint package from Electronic Arts and find out for yourself how good it is...

# The new HAM-supporting DeluxePaint® IV will do more than turn a few heads.

It will also turn them inside out, upside down, spin them on an axis, or metamorphosise them into hairy rock stars before you can say "Tutankhamen".

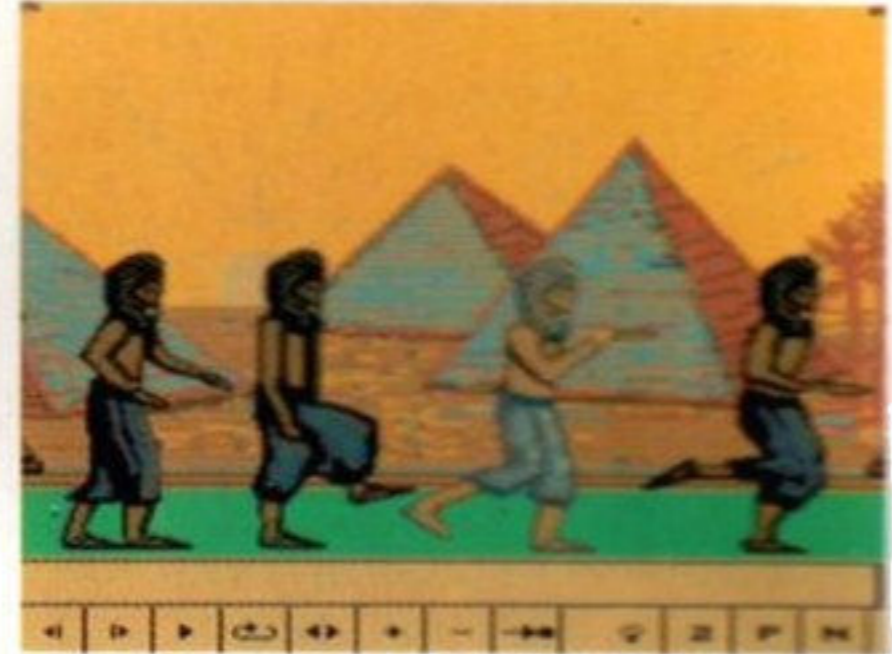
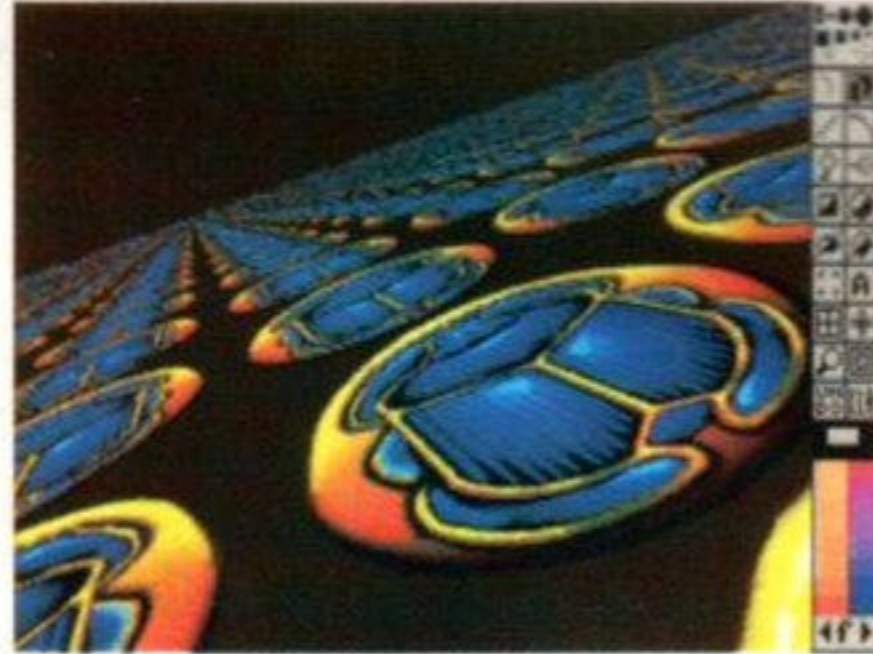

With Hold And Modify (HAM) video mode, DeluxePaint IV offers a staggering 4096 colours. This means gradients that are smoother, more versatile and easier to define.

Not only can you paint in HAM, you can animate in it, too. Imagine brilliant images, rendered in 4096 colours, moving effortlessly across the screen.

DeluxePaint IV makes animation easy for you. The special LightTable feature allows you to review the last frame of animation while previewing the next.

Or choose two different images - say a caterpillar and a butterfly - and DeluxePaint IV will carry out an amazing metamorphosis between them in as many frames as you wish.

All these features are directed from a new video-style Animation Control that makes animating as easy as pressing a button.

So whether painting or animating, you can now achieve smooth, seamless effects of unbelievable subtlety.

But don't take our word for it.

Steve Franklin, Managing Director of Commodore Business Machines, described DeluxePaint IV as *"a stunning innovation and probably the best software package for this market"*.

**Available 27th September 1991**

**£89.99**

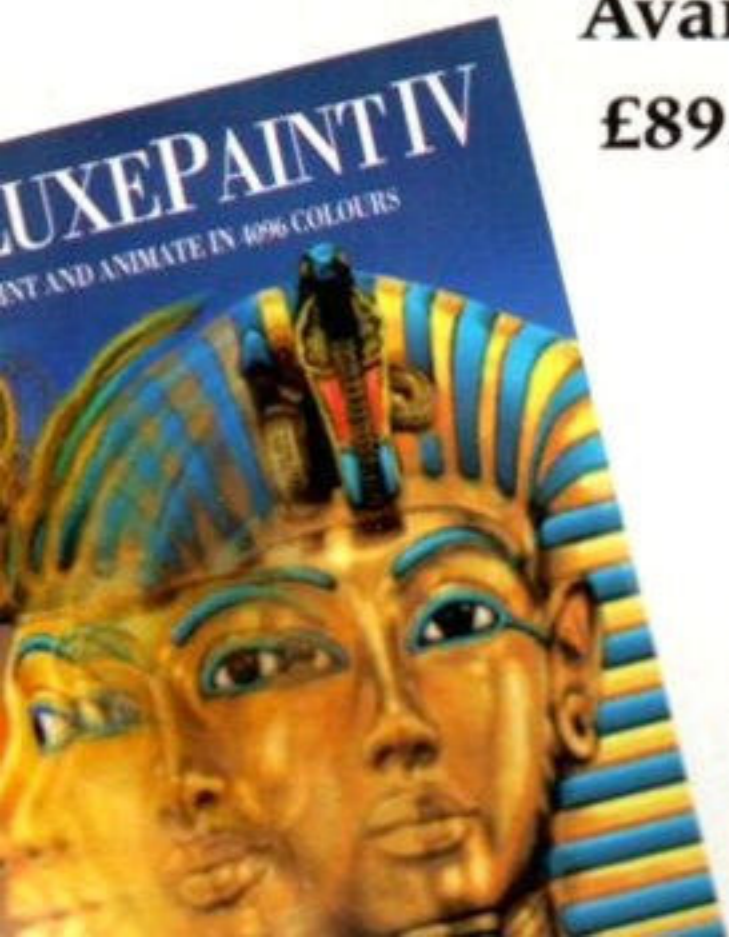

**ELECTRONIC ARTS**

11/49 Station Road Langley Berks SL3 8YN, England.

Tel: 0753 549442 Fax: 0753 546672

**TO UPGRADE** from previous versions of DeluxePaint, send the front cover of your manual with a cheque or postal order to the Direct Sales Department at Electronic Arts Ltd. An upgrade from DeluxePaint I costs £65, from II costs £55 and from III £45. Call 0753 549442 for details of this and the special videos which will help you make the most of DeluxePaint IV.

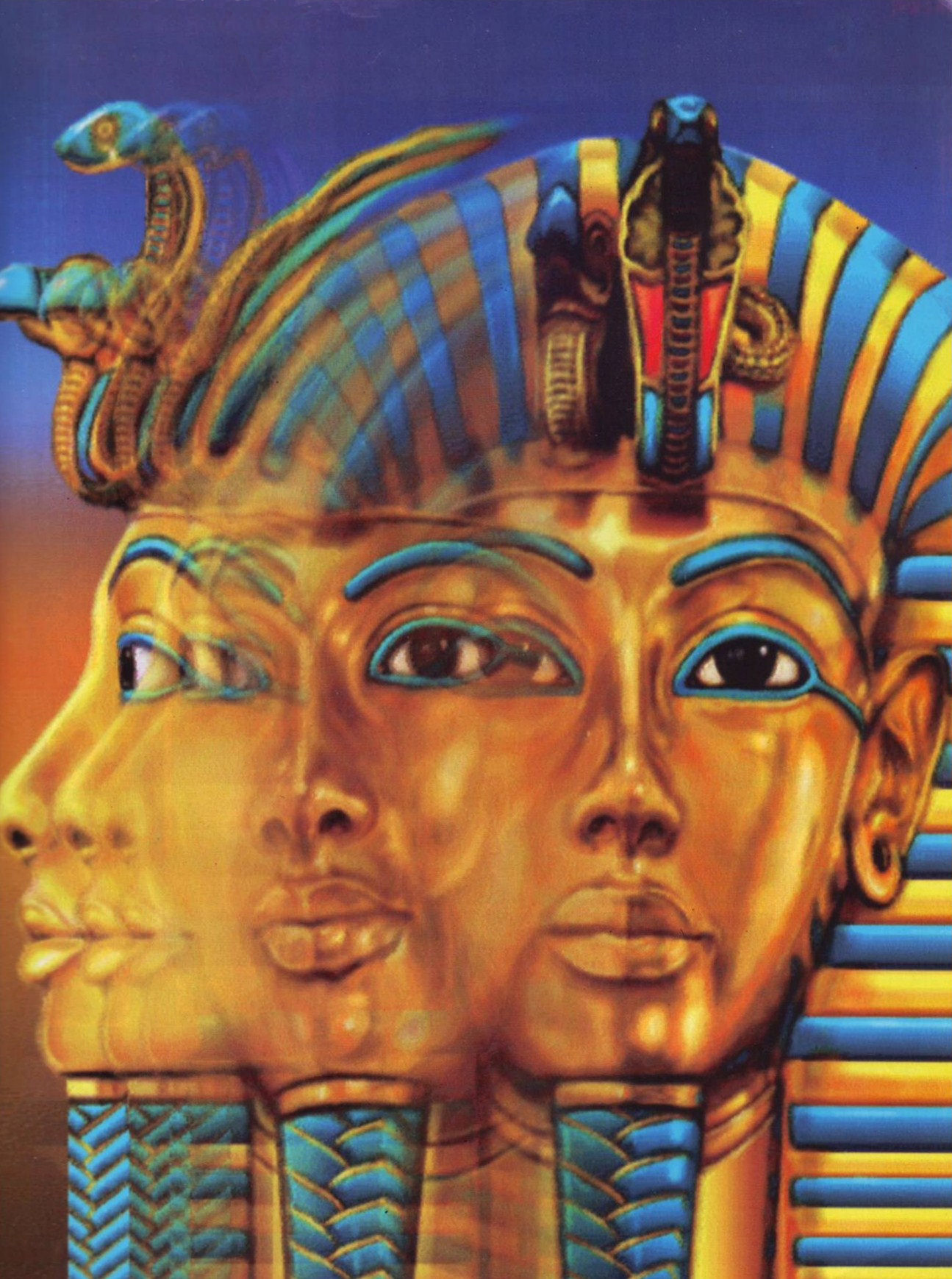

# GODS

THE BITMAP BROTHERS

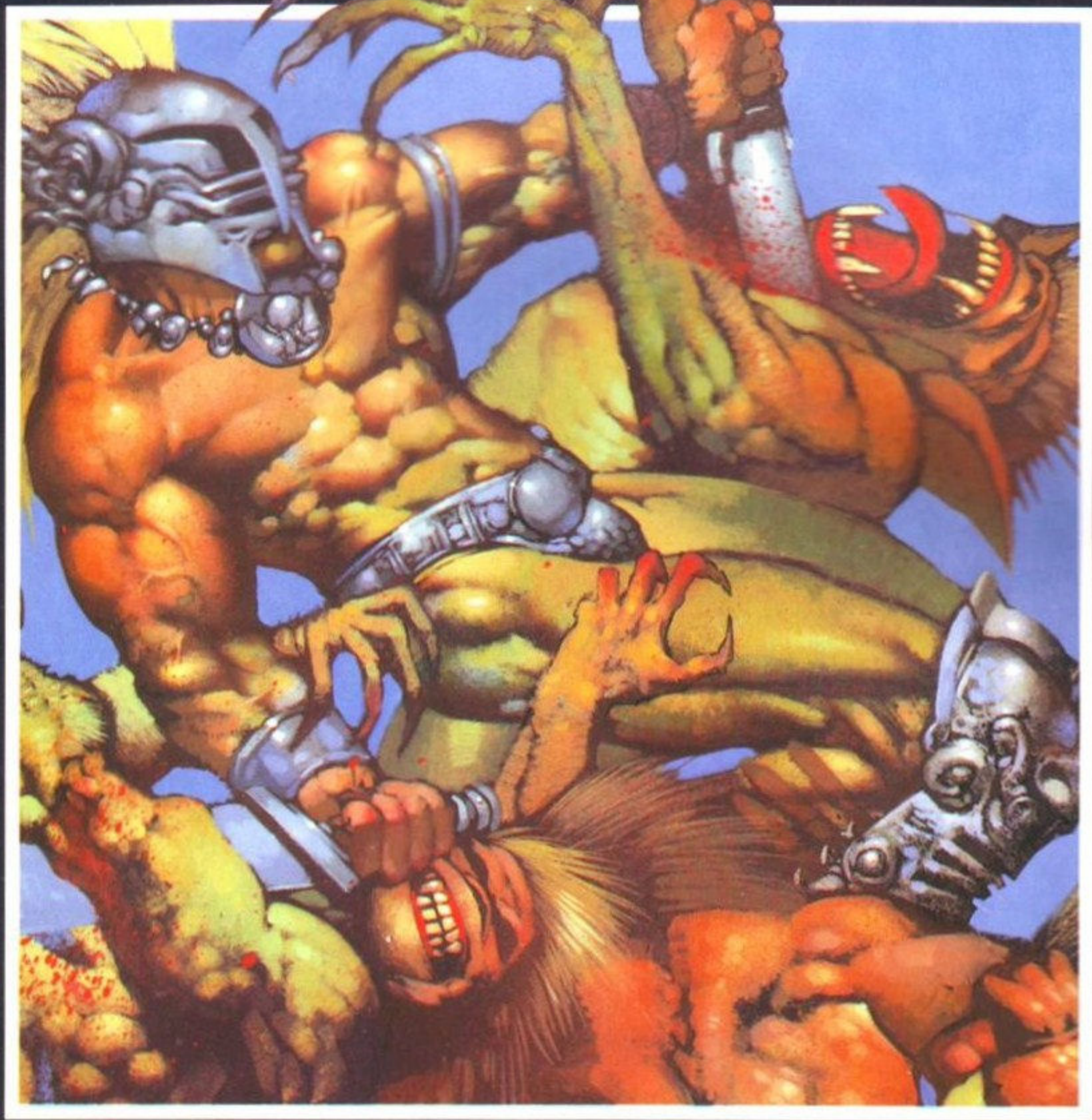

## “Spankworthy”

Paul Ledbury – Oxon (Registered God)

### Have you got what he's got ?





# NEW AMIGA 500 BUNDLE THE STRONGEST EVER?

Cartoon Classics deal includes 1Mb, Lemmings, Bart Simpson, Captain Planet and Deluxe Paint 3

The new Amiga 500 'Cartoon Classics' bundle, which Commodore will be selling throughout this year, over the busy Christmas period and into the new year, is widely expected to be the strongest yet. But doubts have already been raised as to the appeal of the cartoon characters central to its success, and to the quality of the games based on them.

There is no doubt that the core of the deal is very strong indeed, with an expanded 1Mb Amiga (it includes the A501 RAM expansion at no extra cost) and, for the first time, *Deluxe Paint III*.

Electronic Arts' top-selling graphics package in its ultimate non-HAM version is an extremely powerful selling point: no doubt EA have decided to include it because the release of *Deluxe Paint IV* (see the exclusive first review on Page 22) has given them a possible upgrade market and because a 1Mb Amiga can make decent use of its features.

The fact that Psygnosis's hugely successful and widely-praised puzzle game *Lemmings* has been included is also cause to think that the bundle will shift in quantity. It's been received as the best game of the year in almost every quarter, making an impact and earning a reputation far beyond the normal computer scene, and may possibly even bring the Amiga a character which could do for it what Mario has done for Nintendo. *Lemmings* breakfast cereal, anyone?

But doubts have been raised over the other two games, licensed from the cartoon characters who are expected to make the same kind of impact that the Turtles made last year. Captain Planet, the ecologically-aware TV cartoon superhero who rushes around saving the earth with his amazing powers, has had an awful lot of hype from a Turtles-conscious media looking for this year's big thing.

If they are right, anything with the Captain's name on will sell big to a younger audience. But there are signs that Captain P will fail to live up to everyone's

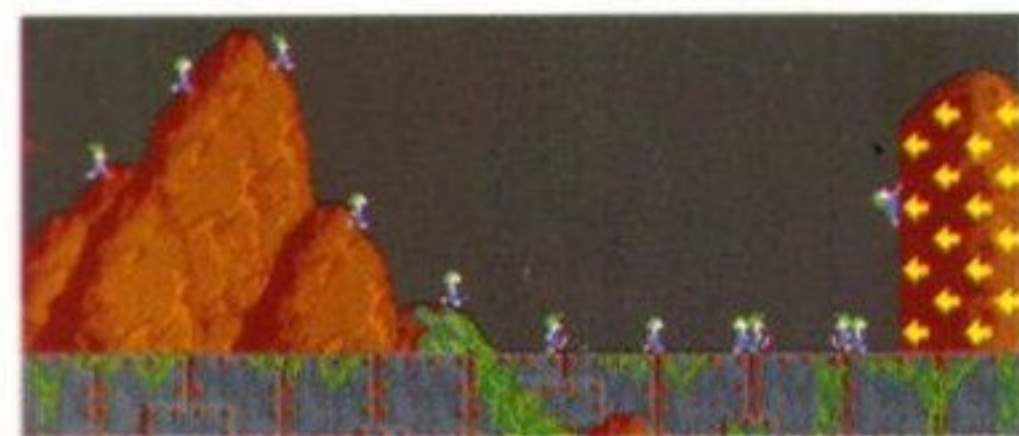

**Lemmings:** the big hit game of the year will help assure the success of the new Cartoon Classics bundle. It even looks possible that the cute green-haired chaps could begin to spin off into areas beyond computers.



**Captain Planet:** could turn out to be this year's duff licence.

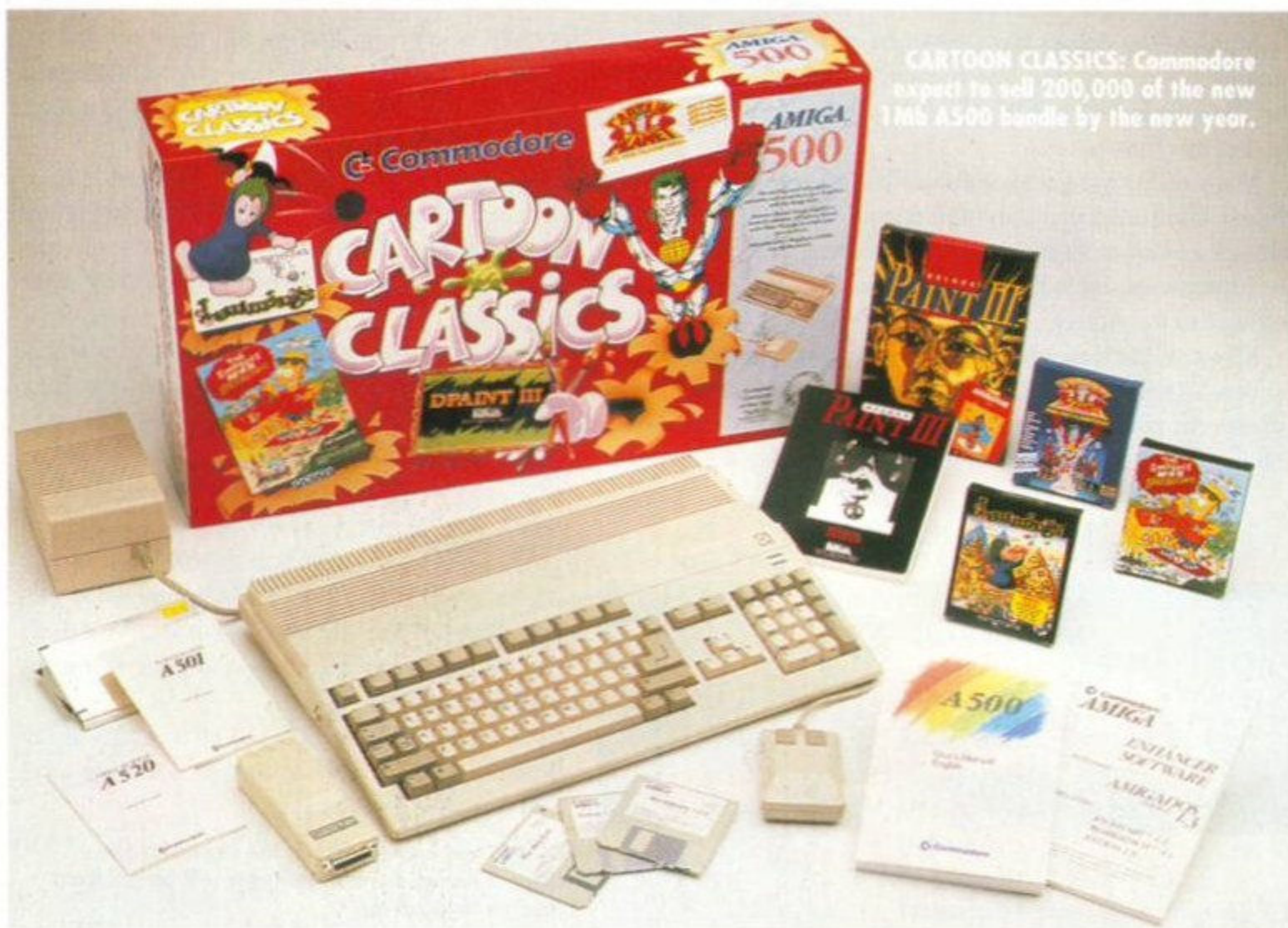

expectations: a straw poll that we carried out revealed that the character lacked the kind of street-wise appeal that made the Turtles a hit.

A further problem lies with the game itself, written by veteran Tony Crowther for Mindscape. The version of the game that appears in the box will be a different one from the one that actually goes on sale in the shops and has its flaws: it seems that the deadlines for inclusion in the Commodore bundle did not allow time to tweak the game to the levels of playability demanded by the sophisticated Amiga market. We've played the bundle version and it certainly lacks a spark.



Steve Franklin, boss of Commodore UK: "The best bundle we have ever assembled".

**Bart Simpson has no credibility problems** and it looks likely that the cult hit cartoon will sell many a product over the next six months. But Ocean's conversion of the game seems to have hit problems, and rumours emanating from the Manchester software house give an impression of dissatisfaction at the quality of the game. With the reception that Mirrorsoft's *Teenage Mutant Ninja Turtles* got at the hands of the press (35% in *Amiga Format's* review, for example) still all too fresh in the memory, Ocean will want to be very careful about releasing a less-than-satisfactory game. As ever, watch this space...

Despite the inevitable doubts over the quality of games from big-name licences, there is every cause for optimism over the prospects of the bundle as a whole. The free RAM expansion, the known quality of *Deluxe Paint III* and *Lemmings* and the lure of the year's two top names mean that every aspect of this bundle is an excellent selling point. We, and many other commentators, believe it will be the most successful Amiga deal to date.

Commodore confidently expect to sell 200,000 new Amigas in this bundle between now and the new year, which means we could go into 1992 with around three-quarters of a million Amiga owners across the UK.

And there is one other ray of sunshine for the Cartoon Classics bundle: each one sold will come with a free Special Edition of *Amiga Format*, introducing new users to all the delights of the Amiga.

**Bart Simpson:** doubts over the quality of the game.



# AMIGA FORMAT TO ORGANISE BIGGEST EVENT OF THE YEAR

Amiga Format and Commodore combine to create the show of the year

November will be a big time for all Amiga owners. The two biggest shows for the Amiga, the Commodore Show and the Ami-Expo, have been combined under one banner and, what's more, *Amiga Format* will be in charge of making it the biggest and best show of the year.

Many of the details have yet to be confirmed, but our influence will be put into making the show not just an exciting place to be, but also a comfortable and pleasant experience. We've found at too many shows in the past that the people who attend somehow seem to be put low on the list of priorities. We want everyone to enjoy their day out this time around.

Many of the top games software houses including Electronic Arts, Mindscape, MicroProse and Psygnosis have already confirmed that they will attend, so you can expect to gain hands-on experience of the Christmas games releases as well as enjoying the glamour and glitz of their stands. We also expect a number of exciting new product announcements, including the UK launch of the Amiga CD-ROM drive, the gadget that will bring CDTV-style software to the Amiga.

Many events throughout the show will include question sessions with top programmers, the CDTV City where the new CD stuff will be shown, a games arcade so you can play all the top new releases, technical seminars and a multimedia theatre where experts will pass on advice about this growing field. There will even be a Christmas Shopping mall where you can actually buy the latest stuff.



The show will run from Friday November 15th to Sunday November 17th (trade-only day on Thursday 14th) and entrance will cost £6 for adults, £4 for under-14s. We've arranged a special discount if you book in advance – details next month – and everyone who goes will get a free show guide.

Last but not least, we'll all be there all the time so you'll be able to find us and have a bit of a chat. See you there!

All this and Earl's Court 2: the venue for the biggest Amiga show of the year will be the most modern in London.

## CHANNEL 4 HOSTS GAMESHOW

Come on down for the first real gameshow on telly: a computer game show, that is! Channel 4 have commissioned a series of ten half-hour programmes under the name Gamesmaster, to start showing in January next year. The series will feature competitions between top players (whoever they are), reviews of new games, international sales charts and tips showing players how to crack the tricky bits of their favourite games.

BBC Scotland's game show *Catchword* has also received a boost from the Amiga, courtesy of Amiga Centre Scotland's Harlequin 32-bit colour card. The Amiga was used to produce animation links and graphics for the show, as well as stereo sound effects. catch the programme on BBC2 in the Autumn.

### SNOOKER STAR'S CUE FOR SUCCESS!

The new 3D snooker game from Virgin, the creation of Archer MacClean, has received a boost with Jimmy White agreeing to lend his name to it (see Page 58 for the review). The game was already expected to be one of the best of the year, but is now assured of sales as well as

critical success. The picture shows Jimmy (left) getting a few tips from Amiga Format expert Trenton Webb: "See if you can hit them red ones in that big triangular bunch down there," advised Trenton...



## CDTV GETS PURE GENIUS AND GOLF

The latest releases for the CDTV include the Guinness Disk of Records and a new golf game based on Accolade's existing Jack Nicklaus licence.

Launched in London just a couple of weeks ago, the Guinness Disk of Records will bring us all those facts and figures we already know and love in the multimedia form of digitised pictures, sampled sounds and speech and, of course, on-screen text. Rumours that it will also feature a digital Roy Castle are very much exaggerated.

Accolade's golf game will take an entirely fresh approach, being based around digitised images of a golf round. While this should give it stunning looks, it remains to be seen what it does to the playability.

Another exciting CDTV announcement is that a third-party developer is to release a keyboard for the system, leaping in ahead of the official product.



The launch of the Guinness Disc of Records in London. The CDTV book will contain thousands of facts and figures presented with digitised graphics and sound.

## ICD GET CARRIED AWAY WITH A500 INTERNAL HARD DRIVE IDEA

New high-storage drives make ultimate Amiga 500 possible



The Novia 20i is an internal hard drive for the Amiga 500: a useful, if very expensive, solution to A500 storage problems and unique... until now.



The arrival of the Prima series of A500 internal drives has brought a new level of power: 52Mb or 102Mb of storage space. But it costs...

Not content with the new Novia 20i internal hard drive for the Amiga 500 (see News, last issue) ICD of America have now announced the release of a further range of hard disk drives that can sit snugly inside the Amiga where the internal floppy drive normally belongs.

While the Novia 20i is a two-inch disk that offers only 20Mb storage for £359 (it's available from Power Computing, 0234 843388), the new Prima series of drives are 3.5-inch units offering 52 or 105Mb of storage space. They are constructed using the latest in low-power 11 millisecond technology from Quantum, the name behind the best hard drive units. US prices are \$650 and \$900 for the Prima 52i and Prima105i respectively, but no UK prices are yet available (distribution should be via Power Computing, 0234 843388).

You will need 1Mb of RAM to use the drives, which are installed using a ribbon cable connecting to an AdIDE interface system which plugs in under the 68000 chip. Also included with each drive is a ShuffleBoard adaptor which allows an external floppy drive to be treated as DF0:, essential if you are to avoid problems booting from floppy disks.

Following the release of the Prima drives, ICD have had Americans drooling over their magazine adverts which feature the ultimate in Amiga 500s. It contains a 105Mb Prima internal hard drive, an AdRAM 540 giving 5Mb of RAM and a Flicker Free Video card to cut Interlace flicker. All we need now is a matchbox-sized power supply and you could have the ultimate A500 system and carry it around with ease! Estimated price of that lot: including the Amiga, round about £1900!



Presents...

# The Air Crew



Select from the list below any **TWO** Spectrum, Amstrad, Commodore 64 or Atari XL/XE games or **ONE** Amiga or ST game - when you join the AIR CREW.



**CAPTAIN COCKPIT**  
"ALL THIS ABSOLUTELY FREE, WHEN YOU SEND US £7.99"

**GILBERT T.H.**  
"IT'S A GREAT BARGAIN WHICHEVER WAY YOU LOOK AT IT"



**STAN GROMMET**  
"JOIN NOW - OR I'LL RE-ARRANGE YOUR BRACKET!"

AIRCREW MEMBERSHIP GIVES YOU.....

1. A SELECTION FROM THE FREE GAMES OPPOSITE
2. GOLD CREDIT CARD STYLE MEMBERSHIP CARD
3. FREE SUBSCRIPTION TO THE BI-MONTHLY AIRCREW MAGAZINE, CONTAINING EXCLUSIVE FEATURES ON ALL IMPULSE, ZEPPELIN PLATINUM AND ZEPPELIN GAMES, FANTASTIC SPECIAL OFFERS, BIG PRIZE COMPETITIONS, INSIDER CHEATS, YOUR REVIEWS, LETTERS, PENPALS AND LOTS, LOTS MORE !!
4. CLASSY A4 MEMBERSHIP CERTIFICATE WITH UNIQUE AIRCREW I. D. NUMBER
5. LARGE AIRCREW HIGH SCORE POSTER
6. INTRODUCTORY FULL COLOUR MAGAZINE WHICH INCLUDES A VOUCHER WORTH £5 OFF THE OFFICIAL AIRCREW T-SHIRT (RRP £10.99)

**ONLY £7.99**

**NORMAN THE NAVY**  
"THIS IS THE MOST EXCLUSIVE GAMES CLUB GOING"



	SPECTRUM	AMSTRAD	COMMODORE 64	ATARI XL/XE	AMIGA	ATARIST
Championship Run						<input type="checkbox"/>
3D Grand Prix	<input type="checkbox"/>					<input type="checkbox"/>
American Football	<input type="checkbox"/>					
Arcade Fruit Machine	<input type="checkbox"/>	<input type="checkbox"/>	<input type="checkbox"/>	<input type="checkbox"/>		
Arcade Trivia	<input type="checkbox"/>	<input type="checkbox"/>	<input type="checkbox"/>			
Ball Blasta			<input type="checkbox"/>			
Bionic Ninja	<input type="checkbox"/>	<input type="checkbox"/>	<input type="checkbox"/>			
Blinky's Scary School	<input type="checkbox"/>		<input type="checkbox"/>	<input type="checkbox"/>	<input type="checkbox"/>	<input type="checkbox"/>
Death Chase	<input type="checkbox"/>					
Draconus	<input type="checkbox"/>		<input type="checkbox"/>	<input type="checkbox"/>		
F1 Tornado	<input type="checkbox"/>	<input type="checkbox"/>				
Fantastic Soccer			<input type="checkbox"/>	<input type="checkbox"/>		
Full Throttle 2	<input type="checkbox"/>					
Full Throttle	<input type="checkbox"/>					
Jasper	<input type="checkbox"/>					
Jocky Wilson's Darts	<input type="checkbox"/>	<input type="checkbox"/>	<input type="checkbox"/>	<input type="checkbox"/>	<input type="checkbox"/>	<input type="checkbox"/>
Kick Box Vigilante	<input type="checkbox"/>		<input type="checkbox"/>			
Las Vegas Casino	<input type="checkbox"/>	<input type="checkbox"/>	<input type="checkbox"/>	<input type="checkbox"/>		
Mazie		<input type="checkbox"/>				
Mirax Force					<input type="checkbox"/>	
Mountain Bike Racer	<input type="checkbox"/>		<input type="checkbox"/>	<input type="checkbox"/>		
Ninja Commando	<input type="checkbox"/>	<input type="checkbox"/>	<input type="checkbox"/>	<input type="checkbox"/>		
Para Academy	<input type="checkbox"/>	<input type="checkbox"/>	<input type="checkbox"/>			
Para Assault Course	<input type="checkbox"/>	<input type="checkbox"/>	<input type="checkbox"/>			
Phantom				<input type="checkbox"/>		
Pro Go Kart Simulator	<input type="checkbox"/>					
Psi-Droid			<input type="checkbox"/>			
Rally Simulator	<input type="checkbox"/>	<input type="checkbox"/>	<input type="checkbox"/>			
Sidewinder				<input type="checkbox"/>		
Spaghetti Western	<input type="checkbox"/>	<input type="checkbox"/>	<input type="checkbox"/>			
Speed Ace				<input type="checkbox"/>		
Turbo Skate Fighter	<input type="checkbox"/>					
World Soccer	<input type="checkbox"/>	<input type="checkbox"/>	<input type="checkbox"/>	<input type="checkbox"/>	<input type="checkbox"/>	<input type="checkbox"/>
Zybex	<input type="checkbox"/>	<input type="checkbox"/>	<input type="checkbox"/>			

To join Captain Cockpit, Norman the Navy, Gilbert Terracotta-Hatchbatch, Stan Grommet & the rest of the AIR CREW pick your FREE GAMES by ticking the boxes, complete this form, and send a cheque or postal order for £7.99 (£8.99 overseas) made payable to Zeppelin Games Limited at The Air Crew, P.O.Box 17, Houghton-le-Spring Durham DH4 6JW.

Name: \_\_\_\_\_  
 Address: \_\_\_\_\_  
 \_\_\_\_\_  
 Postcode: \_\_\_\_\_

DOB: / / Computers  Spect  Amst  C64  XL/XE  
 Owned:  Amig  ST  PC  Console

## GAMES CREATOR SEEKS ADVENTURE FANS WITH VISION

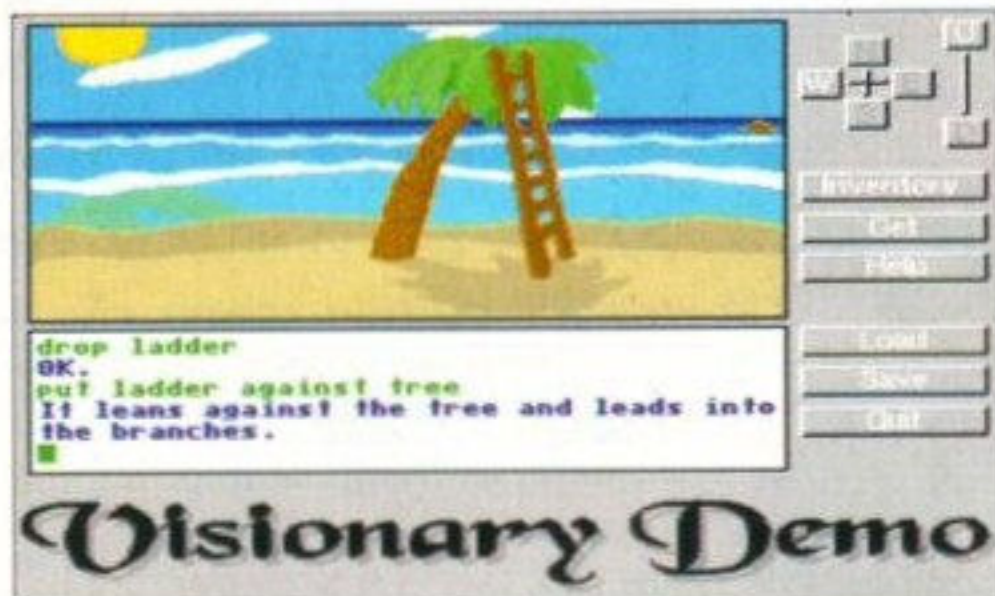

**Visionary** is the new adventure-creating system from Oxxi-Aegis. Early demos give you an idea of the system.

There's been a revival in the DIY games scene lately, with the release of the excellent *3D Construction Kit* from Domark to let you make your own Freescape-style games and the various extensions and improvements to AMOS, Mandarin's game-orientated Basic programming system. But there's been nothing for adventure fans – until now. *Visionary* is a new game creation system aimed especially at adventure

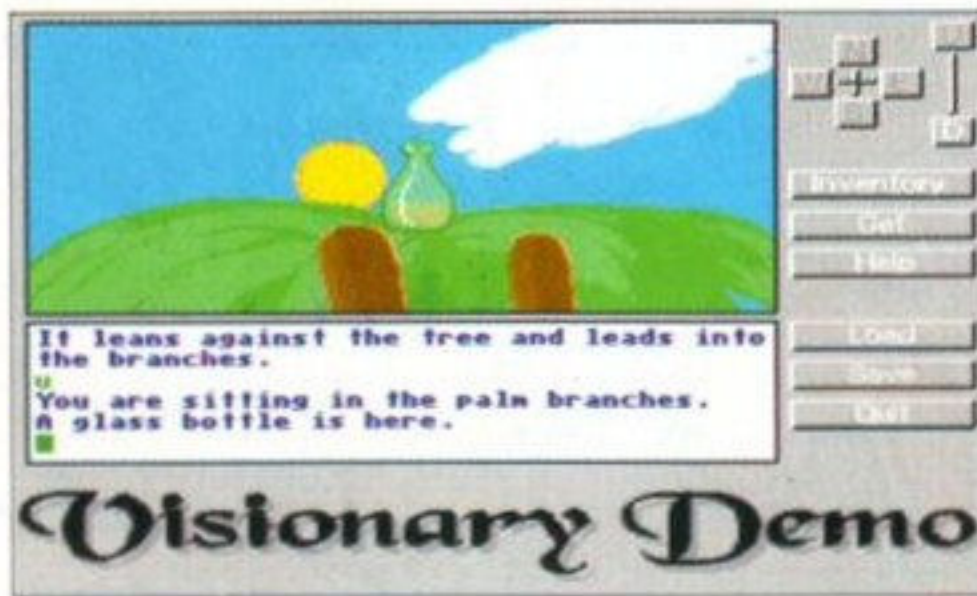

The adventure is presented graphically, but graphic interaction is limited to a few buttons. Text does the rest.

gamers and produced by Oxxi-Aegis of America, best known in this country for the HAM animation and paint package *Spectracolour* and the sound sampling software *Audiomaster*. *Visionary* is a simple system for putting together your own graphic adventures and the nice thing about the system is that it allows graphic 'point-and-click' interaction as well as having a powerful text parsing system. Full review soon.

## NEW PROTEXT ANNOUNCED



**Protex 5**: now updated to Version 5.5. The main addition is a thesaurus, but there are other tweaks too.

Armor have once again upgraded their top-flight word processor *Protex*, taking it to version 5.5. The major improvement is the inclusion of the long-awaited and much-needed thesaurus. Based on the *Collins Pocket Thesaurus*, this will offer writers the choice of 827,000 alternatives picked from 43,000 head words – cross referenced by type and usage.

Other improvements and fine tuning include an option to run the program in a custom screen; automatic hyphenation; widow and orphan control; analysis of text by word redundancy; viewing of files by date and size; and mail-merge linked directly to the database *Prodata*. The spelling checker has also been enhanced to catch simple grammatical errors such as repeated words ("the the spelling...") and lack of capital letters at the start of sentences.

*Protex 5.5* will retail at £152.75, with upgrades costing £30 from version 5 and £60 from 4.3 or 4.2. But is *Protex* getting too expensive? Armor's Doug Thompson commented, "Since the early days, *Protex* has been the 'writer's choice'. At the expense of fancy graphics it offers speed when manipulating even a very large document, logical keystrokes, and a wide range of other facilities such as allowing the user to modify or create printer drivers." Expect a full review soon.



**ProData** is also revamped and improved with the release of Version 1.2, finally gaining pull-down menus.

An upgrade of *Prodata* has also been announced. The new version 1.2 offers enhancements such as pull-down menus, control from either mouse or keyboard, label printing, automatic record numbering and a merge database facility. *Prodata 1.2* costs £99.88. An upgrade for 1.1 users is available for £35.25. Armor 0733 68909

## CLEVER CARD

Here's a sensible idea: you can now buy blank cardboard keyboard overlays and write in your own key codes on them. It's dead useful for remembering the key commands of anything from paint programs like *Deluxe Paint* to flight sims like *F-19 Stealth Fighter*. The overlays are already cut out and fit neatly over the keys: they come in packs of five for £5. Silverbird 0525 52614



## TURBONUTTER MODEM

Possibly the fastest modem ever to hit the market, this is the Supramodem 9600. It has V.32 and V.42 bis support, allowing it to transfer data at rates up to 38,400 BPS. If you want the fastest modem ever, phone Surface UK 081 566 6677.

## TROUBLE BUYING PIXEL 3D?

If you're having any trouble getting hold of a copy of *Pixel 3D*, the bitmap-to-3D converter featured in the last issue, we recommend that you go to the guys who import it. Contact Comp-U-Save on 081 848 7398.



**Pixel 3D**: great for converting bitmap images to 3D.

## SHARP PRINTER PRICES

If you were fascinated by the DTP feature in the last issue and rushed out to find a Sharp printer like the one we used, you should note that the prices we quoted for Sharp printers in the feature were actually incorrect. Please telephone Silica on 081 309 1111 to find out the correct prices.

## SHARP SCANNER NEWS

This is a real Stop Press, this one, but we've just had details through from ASDG in America of their new *Professional Scanlab II* package that will allow you to use the Sharp range of scanners from the JX-300 right up to the JX-650. It provides a full WYSIWYG interface on the Amiga 2000 or 3000 for full-colour scanning and is compatible with *Art Dept Pro* (see Pages 124-5). For details either phone ASDG America on 0101 608 273 6585 or wait till next issue.

## PIRATES STUNG BY FAST SUCCESS

Continuing their campaign against piracy, the Federation Against Software Theft (FAST) have announced the successful prosecution of a computer dealer in the midlands, who was copying leisure software in his shop. The man received a sentence of three months' imprisonment.

We've recently heard of many cases of newly-released games being sold in pirated versions, and it is this kind of large-scale commercial piracy that FAST is out to prevent. During the month of June sixteen raids in England and Wales netted a total of over 10,000 illegal disks. FAST's only problem may be that in some cases they're up against the kind of people who solve problems by hitting them over the head with half a brick...

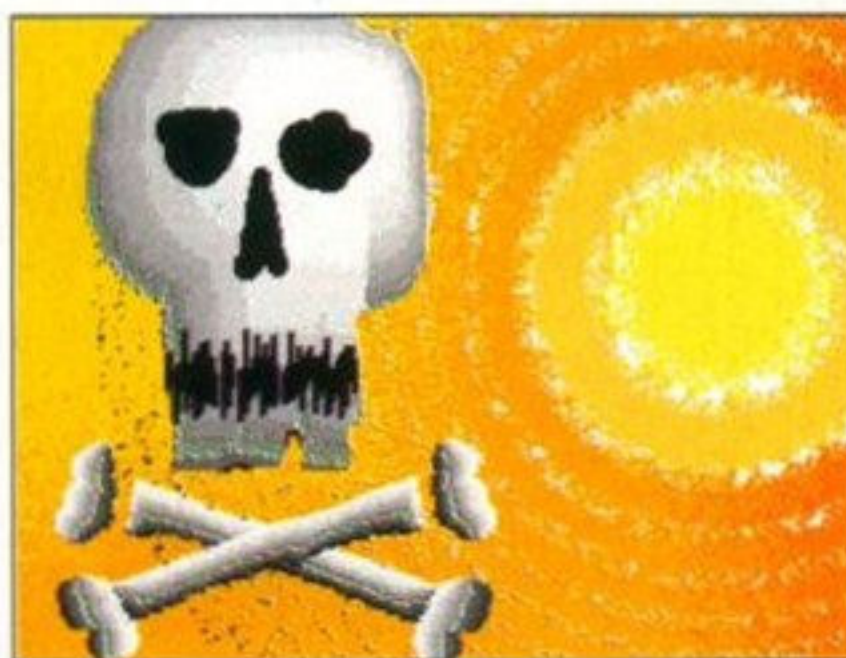

*When You're  
SERIOUS  
About Your  
Amiga...*

**Get Serious.**

**Get To Know Us.**

## **GOLD DISK - Serious Software For The Amiga.**

When it comes to productivity software, Gold Disk can provide everything you need. We are the leaders and we got there by providing the most professional products for the job. If you want to unleash some of the real power of your Amiga computer, we can help. If you're ready to get serious, you're ready for Gold Disk.

### **Professional Page 2.0**

*the best gets better*

Desktop Publishing. For everything from a note to a newsletter to advertisements like this, Professional Page 2.0 can make your task easier, and your output more professional. Outline fonts. Text and graphic rotation. Style tags. Built-in word processor/ spell checker. Pantone and 24-bit colour support. And continual refinement keeps Professional Page on top. "...The best all round workhorse has got to be Pro Page 2.0. It's solid and totally trouble free." - Amiga Format 3/91.



### **ShowMaker**

*the complete desktop video solution*

ShowMaker makes it easy to create exciting video productions right on the desktop. Whether you simply need to sequence animations, or you need to integrate full motion video with Toaster effects and MIDI, ShowMaker can make you a professional. And it's PAL compatible. "For independent producers, ShowMaker is a big step forward." - Television Broadcast magazine 7/90.



### **HyperBook**

*free-form personal information manager*

HyperBook is the ultimate Amiga tool for quickly and easily managing information and creating interactive presentations. Simply by pointing and clicking you can create applications like personalized appointment calendars, business presentations with interactive charts and graphs, and free-form educational teaching "books". "Value: Excellent. Nothing else on the market comes close." - Amiga Format 4/91.

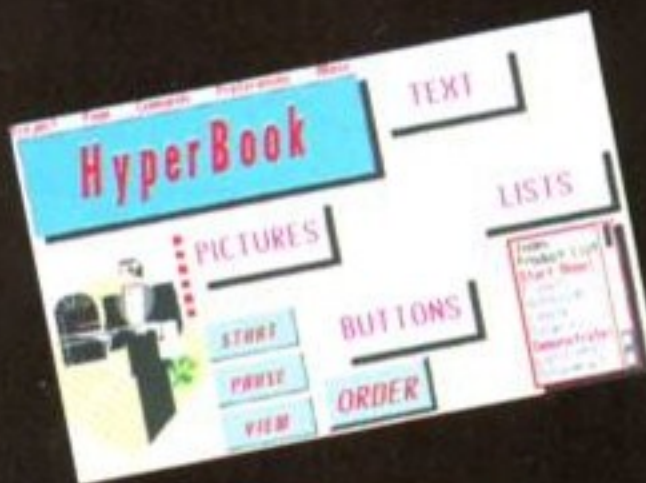

### **Gold Disk Office**

*complete integrated business package*

Gold Disk Office is everything you need to succeed in business or set up a great home office: Powerful Spreadsheet, Graphing program, Database, Word Processor with English Spell Checker, and Desktop Publishing program. All the programs in Gold Disk Office are designed to work together and take full advantage of the Amiga's powerful multitasking. "...A package of five separate and powerful business programs that are as easy to use as they are to buy." - Amiga World 2/91.



These are just four of a complete and growing line of professional grade software from Gold Disk. Also look for The Advantage spreadsheet, MediaShow presentation package, PageSetter home publisher, TransWrite high performance word processor, Gold Disk Type outline fonts, and others.

If your dealer doesn't have the Gold Disk product you need, tell him to contact these authorized distributors:



**GOLD DISK**

This document produced with Professional Page 2.0

Centresoft/IBD 021 625 3388  
HBM 0753 686000  
SDL 081 300 3399

**...GOLD DISK**

**Has**

**Everything**

**You Need.**



**Amiga Software**

3D CONSTRUCTION KIT	31.99
3D POOL	7.49
4D SPORTS BOXING	17.49
4D SPORTS DRIVING	17.49
A10 TANK KILLER (1 MEG)	22.99
AFRIKA CORPS	19.99
AFTERBURNER	6.99
ALCATRAZ	16.99
AMNIOS	17.49
AMOS (GAMES CREATOR)	30.49
AMOS 3D	20.99
AMOS COMPILER	18.49
APB	6.99
AQUAVENTURA	17.49
ARKANOID 2	6.99
ARMOUR-GEDDON	17.49
ATOMIC ROBOKID	7.99
ATOMINO	17.49
AWESOME (WITH T-SHIRT)	15.49
B.S.S JANE SEYMOUR	16.99
BAAL	3.99
BALLYHOO (INFOCOM)	7.99
BANDIT KINGS OF ANCIENT CHINA	21.99
BARDS TALE 2	8.49
BARDS TALE 3	17.49
BATMAN - CAPED CRUSADER	6.99
BATTLE OF BRITAIN	19.99
BATTLE SQUADRON	7.99
BATTLECHESS 2	17.49
BATTLESCAPES	19.99
(BORODINO & ARMADA)	19.99
BEAST 2 (WITH T-SHIRT)	12.99
BEAST BUSTERS	17.49
BETRAYAL	19.99
BILLY THE KID	16.99
BIRDS OF PREY (1 MEG)	19.99
BLACK LAMP	5.99
BLADE WARRIOR	17.49
BLOOD MONEY	6.49
BLUE MAX	19.99
BOMBER MISSION DISK	7.49
BUDOKAN	8.49
CADAVER	16.99
CAPTIVE	16.99
CARDINAL OF THE KREMLIN	16.99
CARRIER COMMAND	7.49
CASHBOOK COMBO (CASHBOOK CONTROLLER & FINAL ACCOUNTS)	45.99
CENTURION DEFENDER OF ROME	16.99
CHAMPIONS OF KRYNN (1 MEG)	19.99
CHAOS STRIKES BACK (1 MEG)	16.99
CHASE H.O. 2	16.99
CHRONOQUEST 2	6.99
CHUCK ROCK	16.49
COHORT - FIGHTING FOR ROME	18.99
CONFLICT EUROPE	7.49
CORPORATION	9.99
CORPORATION MISSION DISK	10.49
CORRUPTION (M-SCROLLS)	3.99
CRACK DOWN	6.99
CRICKET (1 MEG)	18.99
CRUISE FOR A CORPSE	19.99
CRYSTALS OF ARBOREA	17.49
CURSE OF THE AZURE BOND (1 MEG) (SSI)	6.99
CUTTHROATS (INFOCOM)	3.99
DAMOCLES	8.99
DAMOCLES - MISSION DISKS 1 & 2	15.99
DAS BOOT (SUB SIM)	19.99
DEATH KNIGHTS OF KRYNN (1 MEG) (SSI)	19.99
DEFENDER OF THE CROWN	7.49
DEJA VU 2	7.99
DELUXE MUSIC CONSTR SET	45.99
DELUXE PAINT 3	39.99
DEMONIAK	19.99
DEUTEROS	17.49
DEVPAC V.2 (ASSEMBLER)	49.99
DGCALC (SPREADSHEET)	26.99
DISNEY ANIMATION STUDIO	61.99
DRAGON BREED	7.99
DRAGON SPIRIT	6.99
DRAKKHEN	11.99
DRILLER	8.99
DUNGEON MASTER (1 MEG)	10.99

DYNASTY WARS	6.49
E-MOTION	6.49
ECO PHANTOMS	16.99
ELITE	9.49
ELVIRA - MISTRESS OF THE DARK (1 MEG)	20.99
ENCHANTER	7.49
EPIC	16.99
EYE OF HORUS	3.99
EYE OF THE BEHOLDER (1 MEG)	19.99
F15 STRIKE EAGLE 2 (1 MEG)	22.99
F16 FALCON	12.99
F16 FALCON MISSION DISK 2	9.99
F18 INTERCEPTOR	8.49
F19 STEALTH FIGHTER	19.99
F29 RETALIATOR	16.99
FERRARI FORMULA 1	8.49
FIRE AND BRIMSTONE	14.99
FISH! (M-SCROLLS)	3.99
FISTS OF FURY (DYNAMITE DUX, NINJA WARRIORS, SHINOBI, DOUBLE DRAGON 2)	19.99
FLAMES OF FREEDOM	22.99
FLIGHT OF THE INTRUDER	22.99
FLIGHT SIMULATOR 2	23.99
FORGOTTEN WORLDS	6.99
FRENETIC	13.99
FUN SCHOOL 2 (2-6 6-8 OR 8+)	12.99
FUN SCHOOL 3 (2-5, 5-7 OR 7+)	15.99
GAUNTLET 2	6.99
GAUNTLET 3	17.49
GETTYSBURG (SSI)	9.99
GFA BASIC V3.0 COMPILER	25.99
GFA BASIC V3.0 INTERPRETER	37.99
GHENGHIS KHANN	21.99
GODS	16.99
GOLF WORLD CLASS LEADERBOARD	6.99
GRAND PRIX CIRCUIT	6.99
GRAVITY	6.99
GREG NORMAN'S GOLF	16.99
GUILD OF THIEVES (M-SCROLLS)	3.99
HARD DRIVIN'	6.99
HARD DRIVIN' 2	7.99
HARLEY DAVIDSON	19.99
HARPOON	19.99
HERO'S QUEST (GREMLIN)	16.99
HILL STREET BLUES	16.49
HITCH HIKERS GUIDE	7.49
HOLLYWOOD COLLECTION (ROBOCOP, GHOSTBUSTERS 2, INDIANA JONES, BATMAN MOVIE)	19.99
HOME ACCOUNTS (DIGITA)	20.99
HOUND OF SHADOW	8.49
HUNTER	19.99
HYBRIS	2.99
IK+	6.99
IMMORTAL (1 MEG)	16.99
INDIANA JONES ADVENTURE	7.99
INDIANAPOLIS 500	16.99
INTERPHASE	3.99
IT CAME FROM THE DESERT (1 MEG)	10.99
ICFTD ANT HEADS DISK (1 MEG)	10.99
J. NICKLAUS GOLF	16.99
J. NICKLAUS UNLIMITED GOLF & COURSE DESIGN (1 MEG)	20.99
J. NICKLAUS VOL 1 COURSES	9.49
J. NICKLAUS VOL 2 INTERNATIONAL COURSES	9.49
J. NICKLAUS VOL 3 CHAMPIONSHIP COURSES 1990	9.49
JAMES POND	9.49
JAMES POND 2 - ROBOCOP	17.49
JET (SUBLOGIC)	14.99
JINXTER (M-SCROLLS)	3.99
JUDGE DREDD	9.99
K-SPREAD 2.0 (SPREADSHEET)	44.99
KEYS OF MARAMON (1 MEG)	16.99
KICK OFF	3.99
KICK OFF 2	13.49
KICK OFF 2 - FINAL WHISTLE	9.49
KICK OFF 2 - GIANTS OF EUROPE	7.99
KICK OFF 2 - RETURN TO EUROPE	7.99
KICK OFF 2 - WINNING TACTICS	6.49
KID GLOVES	6.99
KILLING GAME SHOW	9.99
KIND WORDS 2 (W/PROCESSOR)	21.99
KINGS BOUNTY	20.49

KINGS QUEST 5 (1 MEG)	26.49
KLAX	13.99
KNIGHTS OF LEGEND	19.99
LAST NINJA 2	6.99
LEISURE SUIT LARRY 3 (1 MEG)	12.99
LEMMINGS	16.99
LOMBARD RAC RALLY	6.99
LORD OF THE RINGS	19.99
LOTUS ESPRIT TURBO CHALLENGE	16.99
MAGNETIC SCROLLS COLLECTION VOL. 1 (GUILD OF THIEVES, FISH AND CORRUPTION) (1 MEG)	19.99
MANCHESTER UNITED - EUROPE	16.49
MEGATRAVELLER 1 (1 MEG)	19.99
MENACE	5.49
MERCENARY	7.99
MERCHANT COLONY	19.49
MERCUS	17.49
METAL MUTANT	17.49
MIDNIGHT RESISTANCE	16.99
MIDWINTER	11.99
MIG 29 FULCRUM	21.99
MONOPOLY	17.49
MOON BASE	23.99
MOONSHINE RACERS	16.99
NAM 1965-75	17.99
NEBULUS 2	16.99
NEVER MIND	6.49
NIGHTSHIFT	7.99
OPERATION STEALTH	17.49
OPERATION WOLF	6.99
OVERRUN (1 MEG) (SSI)	19.99
PANG	16.99
PAWN (M-SCROLLS)	3.99
PGA GOLF TOUR	16.99
PLANETFALL	7.49
PLAYER MANAGER	7.99
POOL OF RADIANCE (1 MEG) (SSI)	19.99
POPULOUS & SIM CITY	18.99
POWER UP (CHASE H.O., TURRICAN, X-OUT, ALTERED BEAST, RAINBOW ISLANDS)	19.99
POWERDRIFT	3.99
POWERDROME	8.49
POWERMONGER	19.99
POWERMONGER DATA DISK 1	11.49
POWERWORKS (MAXIPLAN PLUS SPREADSHEET, KIND WORDS 2 & INFOFILE DATABASE)	37.99
PRINCE OF PERSIA (1 MEG)	16.99
PRO TENNIS TOUR 2	16.99
PROJECTILE	8.49
PROTEXT W/PROCESSOR V5	92.99
QUESTRON 2 (SSI)	6.49
R-TYPE	6.99
R-TYPE 2	16.99
RAILROAD TYCOON (1 MEG)	22.99
RAINBOW COLLECTION (BUBBLE BOBBLE, RAINBOW ISLANDS & NEW ZEALAND STORY)	14.49
RBI BASEBALL 2	19.99
RENEGADE LEGION	19.99
INTERCEPTOR (SSI)	22.99
RICK DANGEROUS	6.99
RISE OF THE DRAGON (1 MEG)	26.49
ROBOCOP	15.49
ROBOCOP 2	16.99
ROCKET RANGER	7.49
RORKE'S DRIFT	15.99
RULES OF ENGAGEMENT (1 MEG)	17.49
S T U N RUNNER	14.99
SEARCH FOR THE KING	20.49
SEASTALKER (INFOCOM)	3.99
SECRET OF MONKEY ISLAND (1 MEG)	17.49
SECRET OF THE SILVER BLADE (1 MEG)	20.49
SHADOW DANCER	17.49
SHADOW OF THE BEAST	7.99
SHADOW SORCERER	17.49
SHADOW WARRIORS	16.99
SILENT SERVICE 2 (1 MEG)	22.49
SILKWORM	6.49
SIM CITY & POPULOUS	18.99
SIM CITY ANCIENT CITIES	10.99
SIM CITY FUTURE WORLDS	10.99
SIM CITY TERRAIN EDITOR	10.49

SINBAD	7.49
SKYCHASE	7.49
SKYFOX	4.99
SNOOKER	17.49
SORCERER	7.49
SPACE HARRIER 2	4.99
SPACE QUEST 3 (SIERRA)	26.49
SPACE QUEST 4 (1 MEG) (SIERRA)	26.49
SPACE ROGUE	19.99
SPACE ROGUE	19.99
SPEEDBALL	7.49
SPEEDBALL 2	16.99
SPELLBOUND	3.99
SPINDIZZY 2	8.99
SPY WHO LOVED ME	16.99
STARCROSS (INFOCOM)	3.99
STARFLIGHT	8.49
STARFLIGHT 2	17.49
STARGLIDER 2	6.99
STELLAR 7 (1 MEG)	17.99
STORM ACROSS EUROPE (SSI)	20.49
SUPER CARS 2	16.99
SUPER HANG ON	6.99
SUPER MONACO GRAND PRIX	17.49
SUPERBASE PERSONAL 2	75.99
SUPERPLAN (1 MEG SPREADSHEET)	75.99
SUPREMACY	19.99
SWAP	17.49
SWITCHBLADE 2	16.99
SWIV	17.99
SWORD OF SODAN	9.99
TEAM SUZUKI	16.99
TEAM YANKEE	19.99
TENTACLE	17.49
TESTDRIVE 2 COLLECTION (TESTDRIVE 2 PLUS DATA DISKS)	19.49
TETRIS	13.49
THEME PARK MYSTERY	5.49
THREE STOOGES (CINEMAWARE)	7.49
THUNDERBIRDS	4.99
THUNDERJAWS	16.99
TIME & MAGIK (LEVEL 9)	11.99
TIMES OF LORE	6.99
TOYOTA CELICA GT RALLY	16.99
TRIAD VOL 2 (MENACE, BAAL, TETRIS)	7.99
TRIAD VOL 3 (SPEEDBALL, BLOOD MONEY, ROCKET RANGER)	15.99
TURBO CUP	4.99
TURRICAN	7.49
TURRICAN 2	15.49
TV SPORTS (U.S.) FOOTBALL	7.49
TV SPORTS BASKETBALL	11.99
ULTIMA 5	20.49
UNIVERSAL MILITARY SIMULATOR 2 (1 MEG)	20.49
VENUS - THE FLY TRAP	8.99
VIRTUAL WORLDS (TOTAL ECLIPSE, DRILLER, CASTLE MASTER, THE CRYPT)	19.99
VIRUS	4.99
VIZ	14.49
WAR ZONE	13.99
WARHEAD	6.99
WARLORDS (1 MEG)	17.49
WATERLOO	7.49
WHEELS OF FIRE (HARD DRIVIN, POWERDRIFT, CHASE H.O., TURBO OUTFUN)	6.99
WINGS (1 MEG) (CINEMAWARE)	10.99
WINNING TEAM (INDICATORS, ESCAPE FTPOP ROBOT MONSTERS, APB, KLAX)	19.99
WISHBRINGER	7.49
WIZBALL	6.99
WONDERLAND (1 MEG) 19.99	19.99
WORDSWORTH (WORD PROCESSOR) (1 MEG)	79.99
WORKBENCH 1.3	14.99
WRATH OF THE DEMON	19.49
XENOMORPH	8.49
XENON 2. MEGABLAST	7.49
XYBOTS	6.99
ZAK MACKRAKEN	7.99
ZORK 1	7.49
ZORK 2	7.49
ZORK 3	7.49

These five classics from Magnetic Scrolls have won over thirty international awards including British Micro Awards 'Game of the Year' for Corruption and The Guild of Thieves.

**AMIGA A590 20 MEG HARD DISK (AUTOBOOT, SOCKETS FOR 2 MEG OF RAM, SCSI INTERFACE FOR PERIPHERALS) .....269.99**



COMPETITION PRO EXTRA CLEAR AUTOFIRE JOYSTICK ..... **13.49**



QUICKSHOT 130F PYTHON JOYSTICK ..... **9.99**

QUICKSHOT 138F MAVERICK 1 JOYSTICK ..... **13.99**



QUICKJOY TOP STAR JOYSTICK ..... **19.99**

QUICKSHOT STARFIGHTER REMOTE WITH TWO INFARED JOYPADS ..... **29.99**

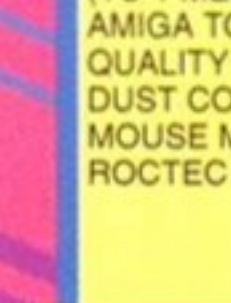

AMIGA 501 RAM EXPANSION TO 1 MEG (GENUINE ITEM WITH CLOCK) FREE BART SIMPSON GAME ..... **64.99**



ROCTEC AMIGA RAM UPGRADE (TO 1 MEG) WITH CLOCK ..... **29.99**

AMIGA TO SCART LEAD (GIVES MONITOR QUALITY ON TV WITH SCART/RGB INPUT) ..... **9.99**

DUST COVER FOR AMIGA (CLEAR PVC) ..... **3.99**

MOUSE MAT ..... **3.99**

ROCTEC MOUSE FOR AMIGA ..... **12.99**

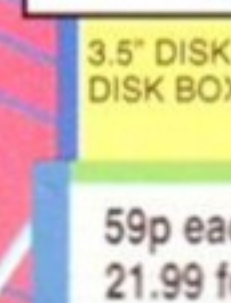

ROCTEC 3.5" EXTERNAL AMIGA DISK DRIVE ..... **53.99**

DELUXE DISK BOX (80 CAPACITY) LOCKABLE ..... **9.99**



3.5" DISK HEAD CLEANER ..... **2.99**

DISK BOX 3.5" (10 CAP) ..... **1.50**

DISK BOX (40 CAP) LOCKABLE ..... **6.99**

DISK BOX (80 CAP) LOCKABLE ..... **8.49**

DISK BOX (100 CAP) LOCKABLE ..... **9.99**

**59p each or 21.99 for 50**

**SONY 3.5" DS/DD DISK + LABEL 59p each or 21.99 for 50**

# 50,000 Members

No obligation to buy

## Special Reserve Games Club



### Gameboy 69.99

Tetris, batteries  
stereo headphones, two player lead  
**FREE** Special Reserve membership  
**FREE** Shockware Gameboy

ALLEYWAY .....	16.99	KWIRK .....	16.99
BALLOON KID .....	16.99	NINTENDO WORLD CUP .....	16.99
BUGS BUNNY .....	19.99	QIX .....	16.99
BURAI FIGHTER DELUXE .....	16.99	RADAR MISSION .....	16.99
CHESSMASTER .....	16.99	REVENGE OF GATOR .....	16.99
DOUBLE DRAGON .....	16.99	SIDE POCKET .....	16.99
DR. MARIO .....	16.99	SOLAR STRIKER .....	16.99
FORMULA 1 RACE (WITH FOUR .....	24.99	SPIDERMAN .....	16.99
PLAYER ADAPTOR) .....		SUPER MARIO LAND .....	16.99
GARGOYLES QUEST .....	16.99	TEENAGE HERO TURTLES .....	16.99
GOLF .....	16.99	TENNIS .....	16.99
HYPERLODE RUNNER .....	16.99	WIZARDS AND WARRIORS .....	16.99
KING OF THE ZOO .....	16.99	HOLSTERS AND BELT (SHOWN) .....	7.99

The Gameboy's high resolution mono screen and superb software provide brilliant playability, and the batteries last very well. Just the thing to take to school, with your Walkman in the second pouch! Yeah - Mondo to the Max!!!!



### Game Gear 99.99

**FREE** Special Reserve membership  
**FREE** Mains adaptor (essential)

COLUMNS .....	16.99	PSYCHIC WORLD .....	16.99
DRAGON CRYSTAL .....	19.99	SHINOBI .....	19.99
G-LOC .....	19.99	SUPER MONACO GP .....	16.99
GOLDEN AXE .....	19.99	WONDER BOY .....	16.99
MICKEY MOUSE .....	19.99	Mains adaptor .....	14.99

Order early, shortages are expected

### COMMODORE CDTV

Remote Control Pad  
Hutchinsons Encyclopedia CD

Lemmings on CD

**FREE** 3.5" Roctec Disk

Drive allowing use of Amiga games

**FREE** Special Reserve Membership

## 599.99

A BUN FOR BARNEY .....	34.49	FUN SCHOOL 3 (2-5 YRS) .....	24.49
ADVANCED MILITARY SYSTEMS SERIES .....	29.49	GARDEN PLANTS .....	34.49
ALL DOGS GO TO HEAVEN .....	34.49	HEATHER HITS HOME .....	39.49
AMERICAN HERITAGE DICTIONARY .....	49.49	HORSE RACING .....	29.49
ANIMALS IN MOTION .....	19.99	HOUND OF THE BASKERVILLES .....	19.99
ANIMATED COLOURING BOOK .....	19.49	ILLUSTRATED HOLY BIBLE .....	34.49
BARNEY BEAR GOES TO SCHOOL .....	29.49	INDOOR PLANTS .....	34.49
BASKETBALL .....	29.49	INDOOR SPORTS .....	29.49
BATTLESTORM .....	29.49	LTV ENGLISH .....	34.49
CASE OF THE CAUTIOUS CONDOR .....	34.49	MANY ROADS TO MURDER .....	29.49
CINDERELLA .....	39.49	MIND RUN .....	29.49
CLASSIC BOARD GAMES .....	34.49	MOVING STOMACH ACHE .....	39.49
COMPLETE WORKS OF SHAKESPEARE .....	34.49	MUD PUDDLE .....	34.49
DEFENDER OF THE CROWN .....	29.49	MUSIC MAKER .....	34.49
DINOSAUR FOR HIRE .....	16.49	MY PAINT .....	29.49
DR. WELLMAN .....	54.49	NINJA HIGHSCHOOL COMIX .....	16.49
F16 FALCON .....	49.49	OUR HOUSE .....	34.49
FRUITS, VEGETABLES AND HERBS .....	34.49	PAPER BAG PRINCESS .....	34.49
		PSYCHO KILLER .....	19.99

SCARY POEMS FOR ROTTEN KIDS .....	39.49
SHERLOCK HOLMES .....	29.99
SIM CITY .....	29.49
TALE OF BENJAMIN BUNNY .....	39.49
THE NEW BASICS ELECTRIC COOKBOOK .....	39.49
THE TALE OF PETER RABBIT .....	39.49
THOMAS' SNOWSUIT .....	34.49
TIME TABLE OF BUSINESS POLITICS .....	39.49
TIME TABLE OF SCIENCE & INNOVATION .....	39.49
TOWN WITH NO NAME .....	19.99
TREES AND SHRUBS .....	34.49
WOMEN IN MOTION .....	19.99
WORLD VISTA ATLAS .....	54.49
WRATH OF THE DEMON .....	23.99
XENON 2, MEGABLAST .....	29.49



## 399.99

Amiga A500  
Cartoon Pack

1 MEG RAM, LEMMINGS, THE SIMPSONS, CAPTAIN PLANET, DELUXE PAINT 3  
**FREE** KIND WORDS 2.0 WORD PROCESSOR  
**FREE** INFOFILE DATABASE  
**FREE** MAXIPLAN PLUS SPREADSHEET  
**FREE** SPECIAL RESERVE MEMBERSHIP



## 299.99

Amiga A500  
Computer

LEMMINGS, CAPTAIN PLANET  
MOUSE, TV MODULATOR  
**FREE** PHOTON PAINT  
**FREE** SPECIAL RESERVE MEMBERSHIP

### Amiga + 2 Games 299.99

NRG colour mag with Cybertoon **NRG** Bi-monthly to members. Don't miss it.

### Biggest and Best.

Huge catalogue. Huge discounts.  
Huge stocks. Huge staff.  
Huge membership.  
**Biggest Value, Best Service**  
No obligation to buy

**Free Colour Catalogue**  
Just phone our sales team on

## 0279 600204

Open to 8pm Weekdays  
and to 5pm Weekends

ANNUAL MEMBERSHIP  
UK £6.00 EEC £8.00 WORLD £10.00  
We only supply members but you can order as you join.

**XS NRG**

costs £14.99 extra but saves you up to £120

Annual subscription to XS NRG is just £14.99 for Special Reserve members only. The price includes:  
6 demonstration disks of pre-release or latest titles.  
6 sets of £20 money-off coupons, redeemable against top items bought from Special Reserve.  
6 issues of XS NRG colour review magazine for Amiga, ST and PC users. Each issue is packed with reviews of new games (and some of the best older ones) and utilities. There's more about the NRG street gang plus cheat modes, bulletin board and club letters. You get more from the club with XS NRG.... That's 18 reasons to buy XS NRG.... here's two more:

We'll give you XS NRG PLUS... all for £29.99.

XS NRG + disks + coupons + Populous + Sim City



Enter XS NRG and pay £14.99.  
Or enter XS NRG PLUS at £29.99.  
These offers apply to UK only. Special Reserve membership is not included.

INEVITABLY, SOME GAMES SHOWN MAY NOT YET BE RELEASED.  
Inter-Mediate Ltd. Registered Office:  
2 South Block, The Maltings,  
Sawbridgeworth, Herts CM21 9PG.

WE ONLY SUPPLY MEMBERS BUT YOU CAN ORDER AS YOU JOIN. THERE IS A SURCHARGE OF 50p PER GAME ON TELEPHONED ORDERS. (PLEASE PRINT IN BLOCK CAPITALS)

AMFORM 14

Name \_\_\_\_\_

Address \_\_\_\_\_

Postcode \_\_\_\_\_

Telephone \_\_\_\_\_ Machine type \_\_\_\_\_

Enter membership number (if applicable) or Membership fee £6 UK, £8 EEC, £10 World

item \_\_\_\_\_  
item \_\_\_\_\_  
item \_\_\_\_\_  
item \_\_\_\_\_

ALL PRICES INCLUDE UK POSTAGE & VAT £

Cheque/P.O./Access/Mastercard/Switch/Visa

Credit card expiry date \_\_\_\_\_ Switch Issue Number \_\_\_\_\_

Cheques payable to: **SPECIAL RESERVE**  
**P.O. BOX 847, HARLOW, CM21 9PH**

Overseas Orders: EEC software orders - no extra charge  
World software orders please add £1.00 per item.  
Non-software items please add 10% EEC or 25% World.  
Overseas orders must be paid by credit card.

NEW PACK INCLUDES THE SIMPSONS!!!

# CARTOON CLASSICS

## CARTOON CLASSICS



### AMIGA 1Mb. CARTOON CLASSICS PACK

This Great New Pack from Commodore offers everything for ALL THE FAMILY. A Great Computer with some Brilliant Games featuring the latest CARTOON HITS...

**AMIGA A500\* COMPUTER with**  
(Complete with Mouse, Leads, Manuals etc as listed \* below)  
**A501 RAM UPGRADE,** OFFICIAL COMMODORE 5.5Mb. Extra Memory Module

Plus  
**CARTOON CLASSICS**  
THE SIMPSONS  
My 1st Space Adventure  
CAPTAIN PLANET  
and The Planet  
LEMMINGS  
The First Winning Game of 1991  
DELUXE PAINT III  
Art and Animation in style!

Only...  
**£372.99**  
BUY A SORCERERS PACK TOO!

## MORE AMIGAS

### AMIGA 1Mb. SCREENGEMS PACK

Std Amiga A500\* & A501 1Mb. RAM upgrade

Back to the Future II  
Shadow of the Beast II  
Days of Thunder  
Nightbreed & Deluxe Paint II

Great Value... **£372.99**



### AMIGA 0.5Mb. 'STAND ALONE' PACK

Standard Amiga A500\* without any software package.

£310

### AMIGA 1Mb. STAND ALONE PACK (inc. A501)

Std Amiga A500\* without software but with CBM A501 0.5Mb. u/g to 1Mb.

£349

### AMIGA CLASS OF THE 90's PACK

Std Amiga A500\* & CBM A501 1Mb. RAM u/g

Pro-Write (WP) Let's Spell at Home  
Deluxe Paint II Talking Turtles  
Deluxe Print II BBC Emulator  
Infofile (D/Base) 10 CBM Disks  
Music Mouse Mouse Mat  
Amiga Logo Resource File

Plus... FREE... Video approved by National Council of Education Technology

Only... **£469.99**

Endorsed by the National Association of Primary Education

Plus... FREE... Video approved by National Council of Education Technology

Only... **£469.99**

### AMIGA 1500 COMPUTER PACK

The supreme Amiga pack for Business, Home, Education and Leisure includes:

Central Processing Unit (CPU)... 1Mb. RAM, two 3.5" Floppy Disk Drives and eight Expansion Slots that will take all Amiga 2000 Peripherals. THE HEART of your system.

Keyboard and Mouse... Plug-in Keyboard with a Numeric Key Pad, 4 Cursor Keys. Two Button Amiga Mouse.

Plus some Superb Software!

THE WORKS: Fully integrated Word Processor, Spreadsheet, & Database

DELUXE PAINT III - 'The New One!'

THEIR FINEST HOUR - The Battle of Britain, POPULOUS - The Promised Lands, SIM CITY - Terrain Editor, and BATTLE CHESS - 3D Animated!

AMIGA 1500 CPU/KEYBOARD (As detailed) **£649.99**

AMIGA 1500 (As detailed) + 1084S Monitor **£899.99**

AMIGA 1500 (As detailed) + CM8833/II **£885.99**

### \*STANDARD AMIGA A500\*

All our Amiga Packs are Genuine UK Spec. with the following standard items/features:

Amiga A500 Computer-512K RAM, Workbench System & Extras Disks, Full set of Amiga Manuals, 4096 Colours, Built-in Speech Synthesis, All Connecting Leads, 1Mb. Internal Disk Drive, Built-in TV Modulator, Kickstart 1.3, Amiga Mouse, Multi-Tasking, Notepad Easy to use basic Word Processor, Stereo Sound.

Remember this is the minimum configuration. Most of our packs contain EVEN MORE!!!

### AMIGA CARTOON CLASSICS + CM8833 Mk II MONITOR

Including the necessary leads and dust covers for both Amiga and Monitor **£615**

### AMIGA CARTOON CLASSICS + CM8833 Mk II MONITOR + STAR LC 200 COLOUR PRINTER

Including the necessary leads and dust covers for Amiga, Monitor & Printer **£815**

### OTHER AMIGA PACKS ALSO AVAILABLE - Phone us for details.

### BUY A SORCERERS PACK WITH ANY OF MERLINS AMIGAS AND SAVE EVEN MORE WITH SOME GREAT PRICES!!!

SORCERERS PACK 1 Quality Mouse Mat £18

SORCERERS PACK 2 DATASTORM, DUNGEON QUEST, E-MOTION, GRAND MONSTER SLAM, SHUFFLEPUX CAFE, KID GLOVES, POWERPLAY, RIV HONDA, MICROPROSE SOCCER, TOWER OF BABEL £25

SORCERERS PACK 3 Sorcerers Packs 1 & 2 Together PLUS... your choice of one Title from Merlins Software Selection £45

Based on £24.99 rrp (See Listings), add difference if reqd. Software not listed can be obtained too. \*PHONE US!

Only when purchased with an Amiga

## AMIGA PRINTERS

star REGISTERED DEALER



### LASERPRINTER 4

Fully HP-iiP & Epson compatible, 300dpi, 1Mb. memory (expandable to 5Mb.), serial/parallel, 14 fonts, RISC processor, full 1yrs on site maintenance.

£999

### LASERPRINTER 4 STARSRIPT

Specification as Laserprinter 4, with an addition of Stars Postscript, 2Mb. Memory, 14+35 fonts. Apple Talk interface. 1yrs on site maintenance.

£1199

### LASERPRINTER 8's available to order

Merlin Express are Citizen Authorised Dealers...

### CITIZEN PRINTER RANGE

120D+ MONO £139

9 Pin Dot Matrix, 240 x 240 dpi, 120/25cps

124D MONO £205

24 Pin Dot Matrix, 360 x 360 dpi, cps

SWIFT 9 MONO £199

9 Pin Dot Matrix, 240 x 240 dpi, 160/40cps

SWIFT 9 COLOUR NEW LOWER PRICE £219

9 Pin Dot Matrix, 240 x 240 dpi, 120/25cps

SWIFT 24 MONO £289

24 Pin Dot Matrix, 240 x 240 dpi, 120/25cps

SWIFT 24 COLOUR NEW LOWER PRICE £309

24 Pin Dot Matrix, 240 x 240 dpi, 120/25cps

### FREE WITH EVERY PRINTER (Marked ⊕ thus) from MERLIN EXPRESS LEAD FROM YOUR PRINTER TO YOUR AMIGA!!!

### MERLIN WORD PROCESSOR AND PRINTER SUNDRIES PACKAGE!!!

Available with any Amiga or Printer purchased from Merlin

☆ PEN PAL... Brilliant Word Proc. with Database/Graphics

☆ 500 SHEETS OF 11x9.5 PLAIN 60 GSM MICRO PERFORATED FAN FOLD CONTINUOUS PAPER

☆ 1-TOP QUALITY THICK PRINTER DUST COVER

☆ 1-UNIVERSAL 2 PART PRINTER STAND

☆ 1-SPARE MONO RIBBON

or just £24.99 without Pen Pal W/P Software

£99.99

## AMIGA PERIPHERALS

### COMMODORE A590 HARD DISK DRIVE

..... 20Mb. Std Unpopulated **£279**

..... 20Mb. Populated to 1Mb. **£329**

..... 20Mb. Populated to 2Mb. **£369**

OFFICIALLY UPGRADED BY COMMODORE NOT A CHEAPER THIRD PARTY U-GRADE!

### COMMODORE 1011 3.5" 2nd DRIVE

For all Amigas: 500/1000/1500/2000, 880K Formatted Capacity, No external power supply required.

CUMANA 3.5" CAX 354 DRIVE **£64.95**

Enable/Disable switch, Throughport.

MERLIN 3.5" DISK DRIVE **£59.95**

3.5" Second Disk Drive, Enable/Disable Switch, Slim Design, 880K Formatted Capacity, No external power supply is needed, Throughport. THIS IS ONE OF OUR BEST SELLERS & GREAT VALUE!

### COMMODORE 1352 MOUSE

Commodore's Own!!! **£39.95**

NAKSHA MOUSE **£29.95**

Amiga/ST switchable, high resolution 280dpi, no additional mouse drivers required, includes mouse holder and mouse mat. E. A. Discount voucher!!!

COMMODORE A501 0.5Mb. **£49.95**

OFFICIAL AMIGA RAM UPGRADE

MIDI-MASTER INTERFACE **£29.95**

1 Through Port, 1 In & 3 Out

RENDALE 8802 GENLOCK **£189.95**

Semi professional Genlock device. Now you can mix both video and computer sources. Ideal titling to high standards.

NAKSHA A500 HAND HELD SCANNER

Coming soon! Look out for this one!!!

## AMIGA MONITORS



### PHILIPS CM 8833/II

14" Stereo Medium Resolution Colour Monitor with Green Screen Switch AND FREE LEAD

2yrs. on site maintenance

Great Value **£244.99**

### COMMODORE 1084S

14" Stereo Med. Res. **£259.99**

Univ. Monitor Stand **£12.95**

Monitor Dust Cover **£5.95**

AV7300 TV Tuner **£79.95**

Tilt/Swivel Stand **£14.95**

(Only fits Philips CM8833 MkII!!!)

## AMIGA SOFTWARE

GODS The Bitmap Bros. at their best! Greek Gods battle against monsters!!! (E25.53rrp) **£19.99**

TOKI Great Platform Arcade Game. 300 screens in fantastic cartoon style! (E24.99rrp) **£19.99**

EYE OF THE BEHOLDER Dungeon Master style game. Great graphics! (E30.99rrp) **£28.99**

PGA GOLF TOUR One of the most realistic golf simulations around! (E25.99rrp) **£19.99**

TEENAGE MUTANT HERO TURTLES A favourite with every youngster! (E25.53rrp) **£18.99**

DUCK TALES Become 'The Richest Duck in the World' in a global race! (E25.53rrp) **£28.99**

ROBOCOP II Based on the film of the same name with the same action!!! (E25.53rrp) **£23.99**

F19 STEALTH FIGHTER Forget the rest... THIS IS THE SIMULATOR!!! (E29.99rrp) **£23.99**

HOLLYWOOD COLLECTION 4 GAMES IN ONE! Batman, Robocop I, Ghostbusters II, Indiana Jones. (E29.99rrp) **£23.99**

### SERIOUS SOFTWARE

FUN SCHOOL 3 Choose under 5's, 5-7's or 7 & over. Educational Fun! (E24.99rrp) **£19.99**

SUPERBASE PERSONAL 2 Keep records with this easy to use & powerful Database (E29.99rrp) **£29.99**

DISNEY ANIMATION STUDIO Outstanding animation for your Amiga. (E99.99rrp) **£81.99**

PHOTON PAINT II Paint prog. IFF/ANIM formats, 4096 colours, etc. (E95.95rrp) **£29.99**

PEN PAL Word processor with database built-in and graphics handling. (E99.95rrp) **£79.95**

# MERLIN

EXPRESS LIMITED

GREAT VALUE, THAT'S THE MAGIC OF MERLIN



STOP PRESS!!!  
A NEW MEDIA REVOLUTION...  
You get... THE NEW CDTV PLAYER with full infra red remote control plus leads to TV and audio system and an introductory 'welcome disc' plus a voucher for Lemmings & Hutchinsons Encyclopaedia

TIME TABLE OF SCIENCE & INNOVATION	ADVANCED MILITARY SYSTEM
TIME TABLE OF BUSINESS POLITICS	MUSIC MAKER
NEW BASICS ELECTRIC COOK BOOK	ILLUSTRATED HOLY BIBLE
THE WORLD VISTA ATLAS	MY PAINT
ALL DOGS GO TO HEAVEN Electric Crayon	PSYCO KILLER
CLASSIC BOARD GAMES	WRATH OF THE DEMON
AMERICAN HERITAGE DICTIONARY	BATTLESTORM
COMPLETE WORKS OF SHAKESPEARE	SIM CITY
BARNEY BEAR GOES TO SCHOOL	A BUN FOR BARNEY
FUN SCHOOL 3 (For the under 5's)	DEFENDER OF THE CROWN
WOMEN IN MOTION (Adults Only)	INDOOR PLANTS
TREES AND SHRUBS	GARDEN PLANTS
FRUITS, VEGETABLES & HERBS	CD REMIX
HOUND OF THE BASKERVILLES	AND...Lots More To Come!!!

Listed below are titles available for CDTV on Floppy Disk using an add on 3.5" Disk Drive

DUNGEON MASTER SPACE QUEST 3 NAM 1965-75

ROCKET RANGER VENUS - The Fly Trap GOLDEN AXE

SPEEDBALL II CHAOS STRIKES BACK IMMORTAL

ROBOCOP II EYE OF THE BEHOLDER AWESOME

LEMMINGS DEFENDER OF THE CROWN GRAVITY

GODS COHORT - Fighting for Rome OBITUS

BRAT ELVIRA - Mistress of the Dark TETRIS

PHONE FOR FULL LISTING OF CDTV TITLES. 5.25" CO. & 3.5" DISKS!

## ALL Merlin Prices include VAT @ 17.5%

## ORDERING

Just telephone our 24 Hour Order Hotline using your Access/Visa Card, or, send a cheque/postal order with your requirement details (cheques need clearance unless issued by a Bank/Building Society on your behalf).

## DELIVERY

Small items are despatched by post FREE to all UK Mainland addresses. Hardware is despatched by courier service (up to 25Kg) as follows: NEXT WORKING DAY...add £7.50 to order, TWO WORKING DAYS...add £6, for SPECIAL SATURDAY DELIVERY...add just £12 (Goods are normally despatched same day as order, unless otherwise discussed at the time).

## WARRANTY

Hardware proving faulty within 30 days will be exchanged for NEW. After 30 days and within 12 months from purchase, faults will be rectified by the relevant manufacturers' repair agent and returned to you by courier. Software and small items carry various warranties, please ask for details.

## COLLECTION

Merlin Express Limited are predominantly a mail order company, but we welcome customers to our trade/collection counter who wish to pick up goods from us. Why not pay us a visit, we are always pleased to help you with your enquiries.

## BFPD & EXPORT

Merlin are happy to supply BFPD and export markets for which VAT is normally deductible. Delivery charges vary from UK rates and, as products carry UK warranties only, faulty items are to be returned to Merlin by the customer and re-delivery charges will apply.

## PLEASE NOTE...

Whilst every effort is made to ensure information in this advert is correct, you should always confirm any offers, prices, availability etc. prior to placing your order. We endeavour to supply goods as shown and will ONLY change details should it be made necessary by our suppliers etc. As our advertising is booked so far in advance Merlin therefore reserve the right to alter product specifications, withdraw any product/offer/service or update prices (and that can be up OR down), without prior notice. Merlin guarantee never to supply anything that has been subject to change without you, the customer, being informed of and agreeing to that change. Please ALWAYS confirm details PRIOR to placing your order.

E&OE



## MERLIN EXPRESS LIMITED

Unit 17, The Riverside Industrial Estate,

High Street, Wotton Bassett, Wiltshire, Wiltshire, Wiltshire, Wiltshire

Telephone: 0602 441442

24 HOUR ORDER LINE

TELEPHONE: 0602

441442

VISA



# CoverDisk

This has to be one of the most exciting Coverdisk line-ups ever! Paint HAM pictures as you try out the biggest non-games release of the year, play the latest corker from The Bitmaps and enlist their help to make your own music. Here's how to use the disk...

## Deluxe Paint IV

The full guide to creating your own HAM pictures and animations is on p26

Electronic Arts

The latest version of EA's top paint package is probably the biggest non-games release of the year. Exciting new additions help you use the 4,096 colours of HAM to the full, providing a heap of new palette tools and multi-colour drawing techniques.

The exclusive Coverdisk demo contains most of the program for you to use, but naturally a few features have been omitted. You can't actually access the range-setting option and all loading-and-saving operations have been disabled.

In order to bring you this exclusive peek, we have a rather early version of the excellent *Deluxe Paint IV* and you have to be a bit careful of one thing. In order to operate windows, such as file requesters, properly without causing the machine to hang up, make sure that the program has finished drawing the box on screen and is ready for your input before you try to do anything. If you don't, the program may decide it doesn't like you and go off in a sulk! Note that the demo will only work properly on machines with 1Mb or more.

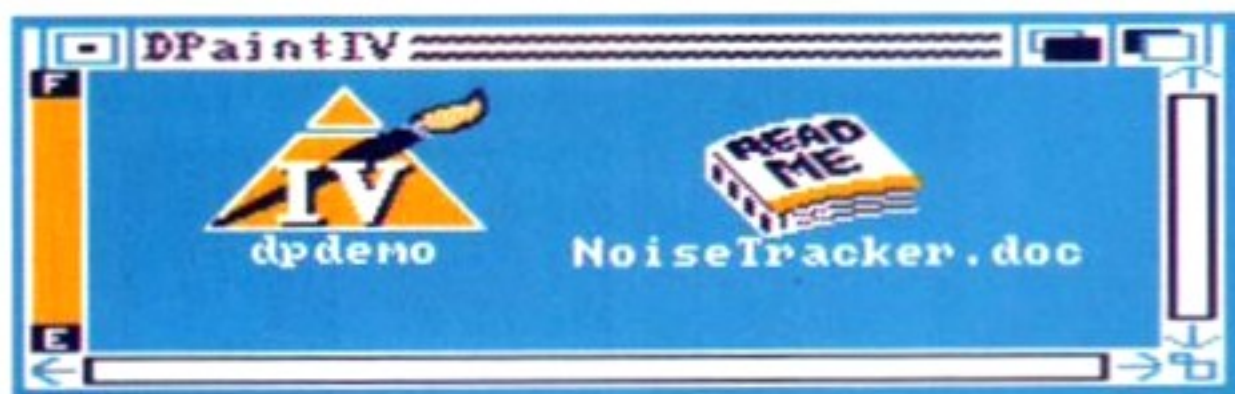

### GETTING STARTED

You'll need to load your Workbench disk to access the *Deluxe Paint IV* demo. Once Workbench has loaded, insert the Coverdisk in the drive and double-click on the disk icon. When the window appears, double-click on the Deluxe Paint icon and the program will load. Now turn to Page 26 to follow the step-by-step guide to using the program!

## Magic Pockets

Find out how to control the Bitmap Kid and guide him to his bike on p32

Renegade

The Bitmap Brothers have a reputation for creating excellent games. The first release on their independent label, Gods, was a huge hit... and it was also an amazing *Amiga Format* Coverdisk 22 demo. Now we bring you another exclusive playable demo, the second Renegade release, and it looks set fair to be as big a hit as the first.

*Magic Pockets* is the game that was featured on ITV's *Motormouth*, where players phoned in and shouted instructions to make our hero, The Bitmap Kid, move around the screen. With all that experience, the game has been massively improved: and controlling it with a joystick is a hell of a lot better too!

The one thing you ought to know before you start is don't plug in an autofire joystick: the weapons system relies on you being able to hold down the fire-button.

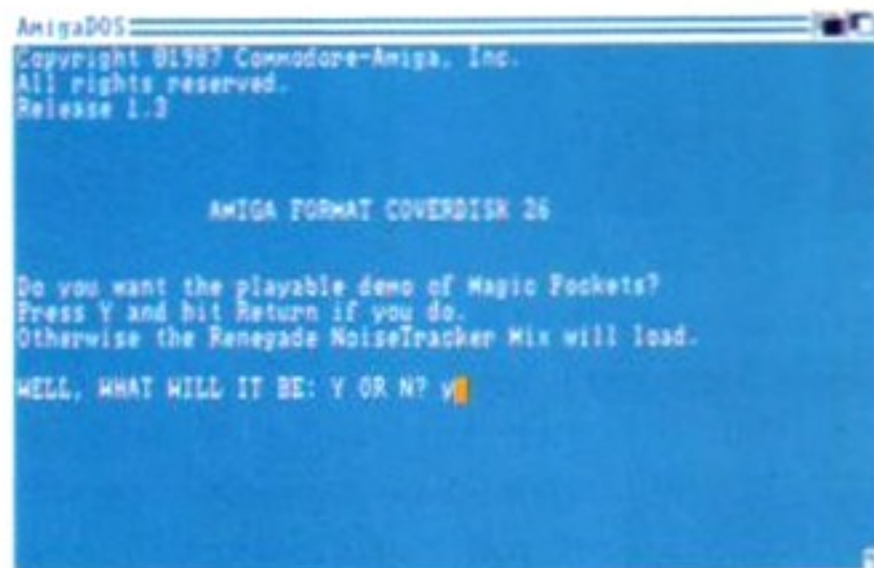

### GETTING STARTED

To load *Magic Pockets*, turn on your Amiga and insert Coverdisk 26 when the Workbench prompt appears. After a few seconds a menu will appear offering you the choice of all the goodies on the Coverdisk. Type in a Y and press the Return key for *Magic Pockets*.

Some wild colour lines will flash about the screen, but don't panic: it's just the game decrunching. After 30 seconds you'll see the intro screen. You are now in demonstration mode, so press Fire to start the game with you in control. Turn to Page 32 to find out how to control the Bitmap Kid as he wanders through his pockets!

## NoiseTracker and Bitmap Samples

Mahoney and Kaktus, Northstar and Silents

Bitmap Samples by Richard Joseph

A complete guide to making your own musical masterpiece appears on p36

You couldn't ask for a more straightforward way of creating your own music. Richard Joseph, the man who creates the music for the Bitmaps' games, has created a backing track using the PD sample sequencer *NoiseTracker*.

*NoiseTracker* is a sample sequencer: it lets you create songs by playing samples from the Amiga's keyboard, recording them as you go and then, when you're happy, saving your tune onto disk. To get you going, Richard has also provided a set of samples which are edited and prepared, all ready for you to set about making your own tunes.

The only minor drawback with the program is that it will only work with Amiga 500s. Apart from that, it's excellent for playing around with.

### GETTING STARTED

To load *NoiseTracker*, turn on your Amiga and insert Coverdisk 26 when the Workbench prompt should appear. After a few seconds a menu will show offering you the choice of all the goodies on the Coverdisk. Type in an N and press the Return key to choose *NoiseTracker*. Wait for just a few seconds and the program screen will appear. Now you're all ready to mix some sounds: turn to Page 36 to find out which buttons to press!

Note that there is also a 'read me' instruction file with the program. You'll need to load your Workbench disk to access it. Once Workbench has loaded, insert the Coverdisk in the drive and double-click on the disk icon. When the

# Using Your Coverdisk

1. Always write-protect your disk. Move the tab so a hole is showing.
2. Copy the Coverdisk and use the copy, not the original. This may sound like a complicated task suitable only for techno buffs, but it's surprisingly simple to do, just follow the simple instructions for copying the disk which are given below.
3. Read the instructions when using the programs.

## Backing up your Disk

First turn on your machine and load Workbench (one of the disks everyone gets with their Amiga). Once the Workbench screen appears and the drive light goes out, remove your Workbench disk and insert the Coverdisk. Once the drive light has gone out your screen should look like this screen.



After the computer has read part of the Coverdisk, it will once again display a requester box asking for the destination disk to be put into df0:. Put the disk that you want the Coverdisk copied to in the drive. This procedure of swapping disks will continue until all of the disk has been duplicated.

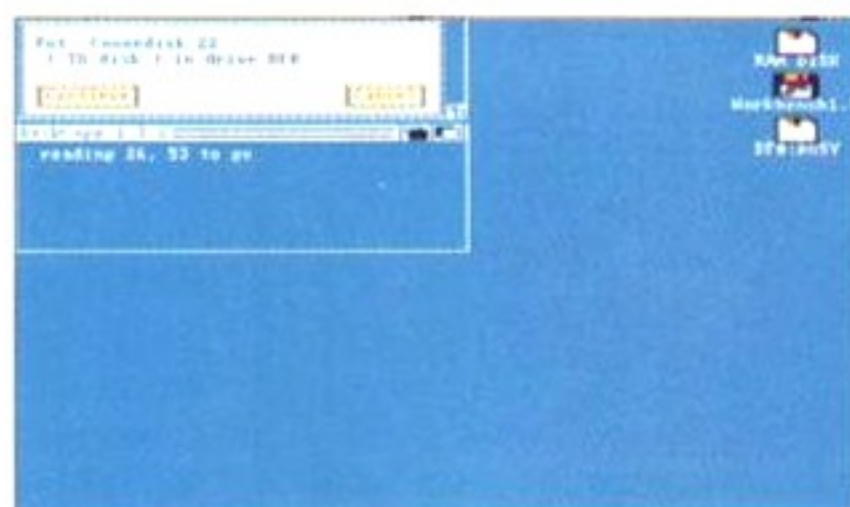

Next, move the mouse pointer to the Coverdisk icon and click once with the left mouse button – the icon will highlight. Press the right mouse button and keep it down. The words 'Workbench', 'Disk' and 'Special' will appear at the top left of the screen. Move the pointer to the word 'Workbench', and a menu will drop down. Select the 'Duplicate' option: you should have got this far.

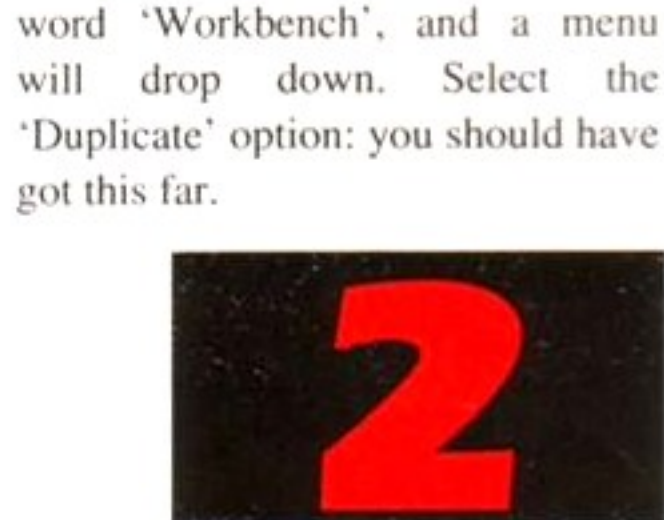

Eventually, you will end up with two Coverdisk icons, one has the name 'Copy of Coverdisk 22'. Click once on this with the left mouse button to highlight it. Bring down the 'Workbench' menu again (by holding down the right mouse button and moving the mouse pointer to the top left) but this time select 'Rename' from the menu. Let go of the right mouse button to select the Rename option.



The computer will ask you to insert the Workbench disk again – it needs to read the command to copy disks. After you've done this, a boxed message (a requester box) will appear, asking you to insert the source disk. Insert the Coverdisk once again and click on the 'OK' option with the left mouse button.



The name of the disk will appear in an elongated box – you don't need to insert Workbench again because the Rename command is built into the machine. Press the 'Del' key (which is next to the 'Help' key) to remove the 'Copy of' part, and press the Return key to make the computer put the new name to copy.



## Disk not working?

We duplicate over 180,000 disks every month. Out of all those, obviously a few will be faulty. If the disk or any of the programs will not load or run properly, there may be a problem. Don't panic!

First try using the *DiskDoctor* utility on your Workbench disk to rescue it before sending it off for a replacement. In-full details of *DiskDoctor* can be found in the user's manual that came with your machine.

However, if your Coverdisk is faulty, you should send it back INCLUDING AN SAE for a free replacement within a month of the cover date to:

Amiga Format September Disk  
Disk Copy Labs  
Unit A, Westmarch  
London Road  
Daventry  
Northants  
NN11 4SA

Remember to include that stamped, addressed envelope!

# The easy Way

There is another way to back up your disk, but because it involves using the typed-in instructions of the CLI or Shell, a lot of people are wary of it. Don't be! simply follow this step-by-step guide and you can't go wrong!



**1** Load your Workbench disk. Open the disk, find the icon that says Shell or CLI and double-click on it.



**2** When the Shell window appears and the drive light is out, type in:  
Diskcopy from DF0: to DF0:  
and press the Return key.



**3.** The Amiga will now ask you to insert the 'source' disk. It means the disk you want to copy, so put the Coverdisk in the drive and press the Return key.



**4.** Wait for a while and it will read all the information off the Coverdisk, telling you how far it has got. Then it will ask you to insert the "Destination" disk. Put the disk you want to copy your Coverdisk onto in the drive and press the Return key. Note that the disk does not need to be formatted already.



**5.** Put the source disk and destination disk in a couple more times when the Amiga asks for them. When it says "Diskcopy Finished" just type in:  
endcli  
to get out of the Shell or CLI. You may have to put the Workbench disk in again. Now your copy is ready!

## DISK PROBLEMS?

If you have a problem with the disk – and you're sure the disk is in full working order – then you may need a little help. If you ring us on any Tuesday, and ask to speak to Pat McDonald, he will do his best to help you. Please understand, giving this sort of advice is time-consuming and we are very busy people, so only call if you really have to and do be considerate if we can't talk to you just then. If the problem is particularly complex it is better to send it to us in written detail. It will then be dealt with in the Workbench pages of the magazine.

## BE CAREFUL!

We have done our best to check that the programs on the Amiga Format Coverdisk are simple to use and have no known viruses. We cannot usually answer complex telephone queries on the software (see the Disk Problems? box) and we do not accept liability for any consequences of using the numerous programs that are on the disk.

## COPYRIGHT

Unless it is specifically stated, the programs on the Coverdisk are not in the public domain and the copyright remains with the author of the program.

Because some of the programs on the coverdisk are not PD, selling or distributing them without the author's specific permission is against the laws of copyright.

# Earn up to £1000

Name .....

Brief description .....

Address .....

Checklist (please tick):

Telephone (Daytime).....  
(Evenings).....

- Stamped-addressed envelope for return
- README.DOC explanation file on disk
- Printout of README.DOC file (if possible)
- Name, address, machine type written on label
- Disk certified virus free

My program name is .....

**IMPORTANT** Please sign this declaration:

This program is submitted for publication by *Amiga Format*. It is wholly my own work and I agree to indemnify Future Publishing against any possible legal action should copyright problems arise.

Approximate total size of files in k.....(we cannot use grams larger than 200K; shorter submissions, under 100K, stand the best chance of publication). It is a:

- Game
- Business utility
- Music program
- Novelty
- Technical tool
- Art program
- Educational
- Other

Signed .....

Date.....

## WE WANT YOUR PROGRAM!

If you've got any programs which you think other readers would find useful, interesting or amusing, we'd very much like to know about them.

**1.** Make sure your program is simple and fool-proof to use. Test it for all those bugs which you are sure you fixed: there are always more.

**2.** Create a file called README.DOC on the disk which explains exactly how to use your program. Try to make it humorous and informative – a good README.DOC gives a program a better chance of going in.

**3.** Fill in this form, sign it, and send it, with your disk (and a print-out of the README.DOC file if possible), to: Coverdisk Software, Amiga Format, 30 Monmouth Street, BATH BA1 2AP. You could win a share of up to £1,000 in prize money.

# GOLD - THE MAR

AWARD WINNING ENTERTAINMENT SOFTWARE  
BY EUROPE'S MOST EXCITING AND

## CRUISE FOR A CORPSE



From the creators of Operation Stealth

Screen shot from CBM Amiga



Based in the 1920's, Inspector Raoul Dussentier is aboard a ship in the Mediterranean. But no sooner has the cruise begun when Raoul is summoned to investigate a crime - the murder of his host Niklos Karaboudjan, the Greek shipping magnate. It's up to Raoul to throw some light on this sinister mystery!

- Wide range of actions, including the option to question other characters in true Agatha Christie style.
- PC version features 256 colours, Ad Lib & Roland sonic support.
- Amiga version features 32 colours.

ATARI ST, AMIGA & PC (CGA, EGA, VGA, TANDY AD-LIB & ROLAND).

© 1991 DELPHINE SOFTWARE. All rights reserved. Cinématique is a trademark of Delphine Software.

## THE SECRET OF MONKEY ISLAND™

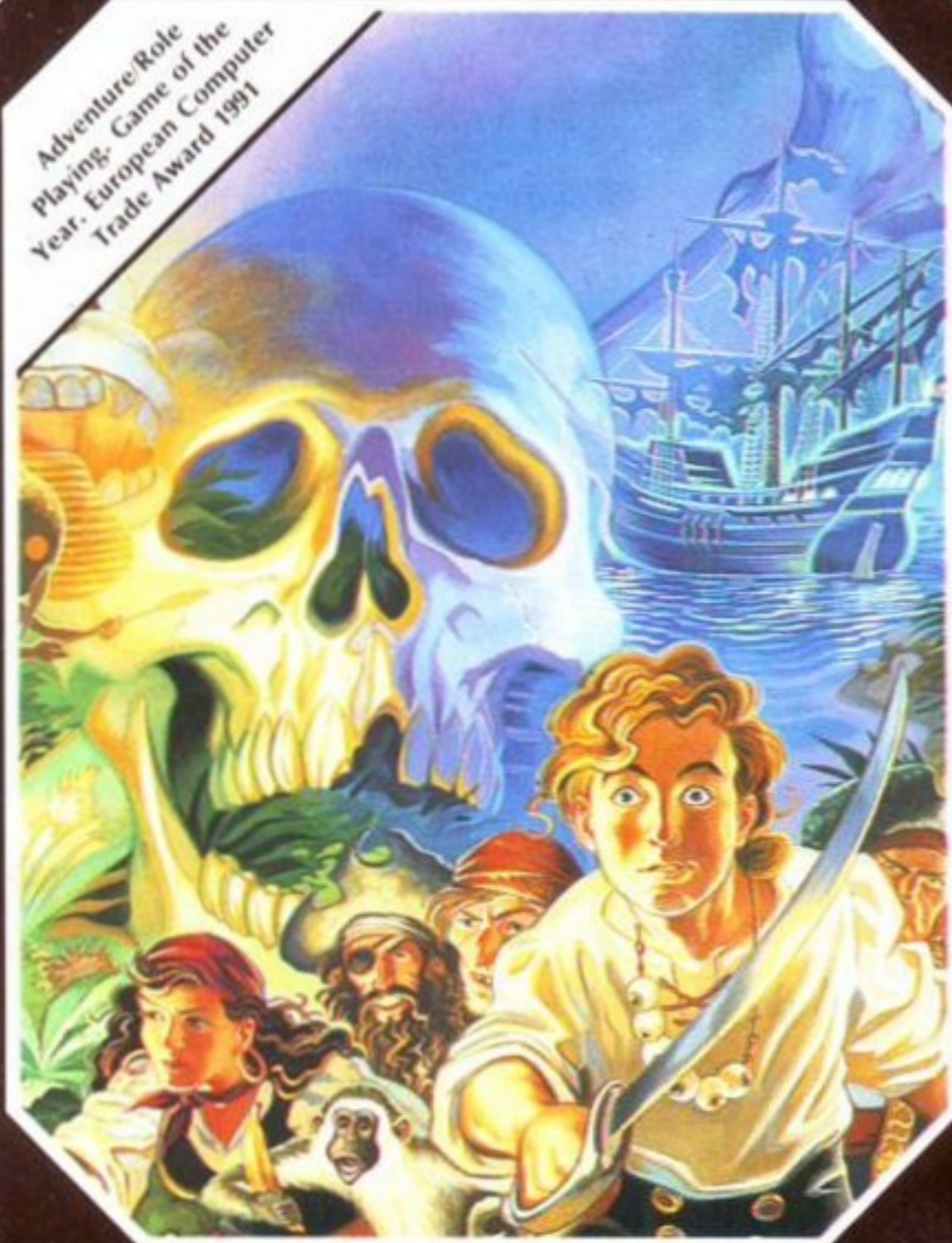

Adventure/Role Playing - Game of the Year - European Computer Trade Award 1991

Screen shot from PC



A comedy set during the "golden age" of piracy in the Caribbean. The game's twisty plot leads our hero, fresh from the old world, on an hilarious, complex, swash-buckling search for the fabled Secret of Monkey Island.

- Features dazzling 3D graphics, an original reggae sound track and a point 'n' click no-typing interface.
- A wide variety of original entertaining puzzles, unravel hidden meanings in hilarious repartee.
- Proportionally scaled animated characters and cinematic pans and camera angles.

ATARI ST, AMIGA & PC (EGA, CGA, VGA, MCGA, AD-LIB and SOUND BLASTER).

© 1990 LucasArts Entertainment Company. All rights reserved.

U.S. Gold Ltd, Units 2/3 Holford Way, Holford, Birmingham B6 7AX. Tel: 021 625 3366.

Cinématique™



NEED HELP? CALL THE  
**GOLD PHONE**  
HINTS & TIPS LINE

HILLSFAR • DRAGONS OF FLAME • HEROES OF THE LANCE TEL: 0898 442025 CURSE OF THE AZURE BONDS • POOL OF RADIANCE • CHAMPIONS OF KETHIN TEL: 0898 442026

LUCASFILM HELPLINE • COMPETITION • INDIANA JONES • ZAK MCCRACKEN • MANIAC MANSION • LOOM • SECRET OF MONKEY ISLAND • BATTLE OF BRITAIN TEL: 0839 654123

Service provided by U.S. Gold Ltd, Units 2/3 Holford Way, Holford, Birmingham B6 7AX.

# K OF A WINNER

SOURCED FROM AROUND THE WORLD OR CREATED  
INNOVATIVE DEVELOPMENT TALENT.

## EYE OF THE BEHOLDER



No 1 best selling game on both sides of the Atlantic

Screen shot from PC



This award winning game is an unbelievable task for beginner or veteran, but believe this, whatever your role-playing experience, Eye of the Beholder will SURPRISE, STIMULATE and CHALLENGE you every step of the way.

*"INCREDIBLE!! EYE OF THE BEHOLDER! DUNGEON MASTER FINALLY BEATEN!"* C&VG.

*"EXCELLENT! Well worth getting hold of a copy!"* Amiga Action.

- Incredible graphic presentation and user interface makes the game state-of-the-art for RPG adventure games.
- Over 150,000 copies sold worldwide.

PC (EGA, CGA, VGA, MCGA, Ad-Lib) and AMIGA.

The TSR Logo is a trademark owned by TSR, Inc. and used under license from Strategic Simulations, Inc. © 1991 TSR, Inc. © 1991 Strategic Simulations, Inc. All rights reserved.



## CYBERCON III

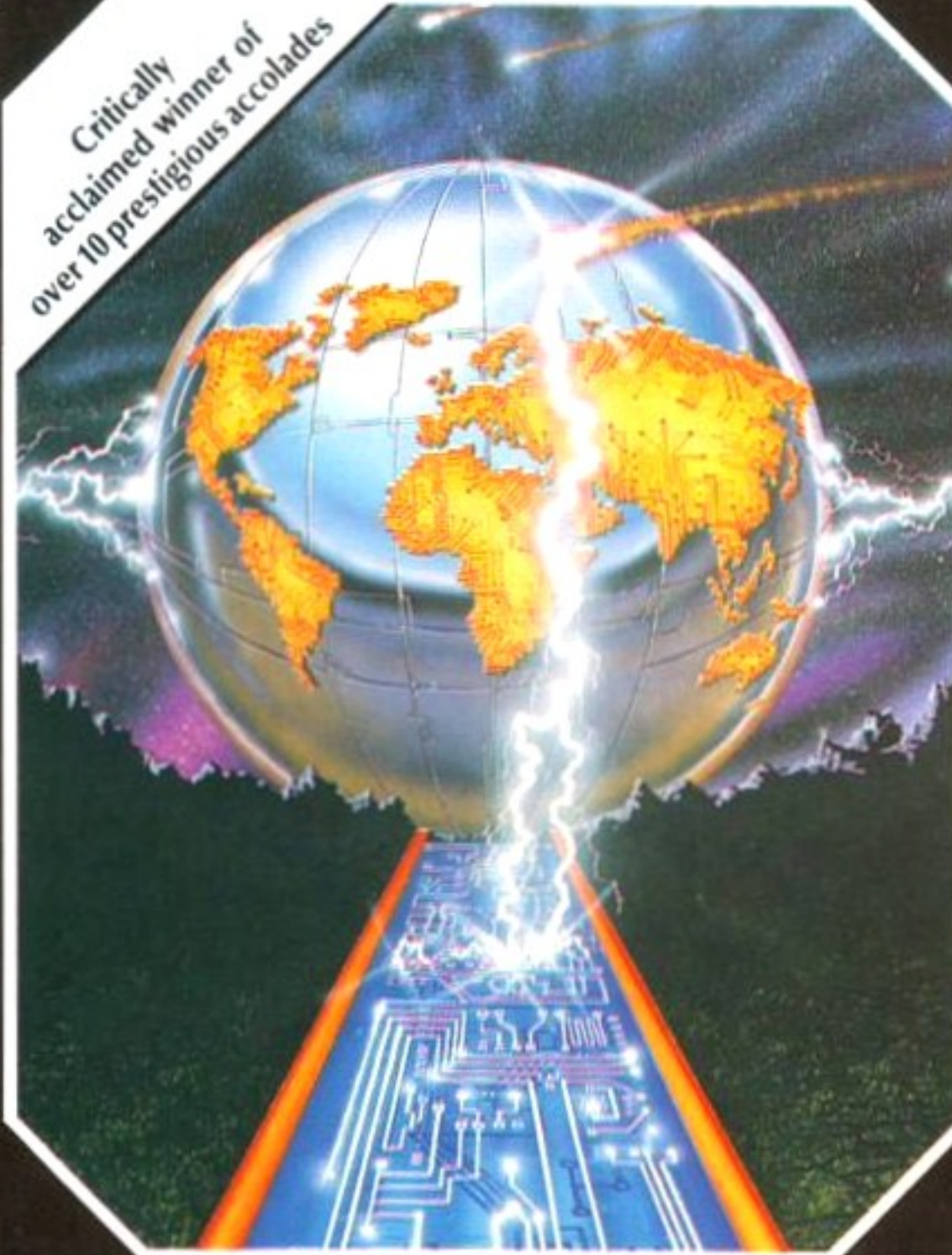

Critically acclaimed winner of over 10 prestigious accolades

Screen shot from CBM Amiga



Cybercon III is a game of Epic proportions.

*"STUNNING, IMMENSE, EXCELLENT, GREAT, DEFINITIVE, ENORMOUS!"* These are just some of the words used by hardened game reviewers to describe this game of epic proportions!

*"A stunningly detailed virtual reality. If you're after the definitive experience, this is where to find it."* CU Amiga.

*"With excellent graphics and acres of gameplay, Cybercon III plunges you into the heart of a defence complex with over 400 unique locations. GREAT STUFF!"* Zero Hero.

ATARI ST, AMIGA & PC.

© and © 1991 The Assembly Line and U.S. Gold Ltd. All rights reserved.

Screen shots are only intended to be illustrative of the gameplay and not the screen graphics which vary considerably between different formats in quality and appearance and are subject to the computers specifications.

After previews galore in the computer press, Amiga Format can now bring you a full review of the long-awaited update to the highly successful Deluxe Paint series. **Maff Evans** sharpens his bitmap pencil and gets his digital paintbrush ready to start creating some HAM masterpieces.

# Deluxe Paint IV

Multi-mode Art and Animation Package  
£89.99 ■ Electronic Arts

DELUXE PAINT HAS long been considered the industry standard as far as paint packages are concerned, with *Deluxe Paint III* being used by more Amiga artists than any other program. However, even *DPaint III* had one serious limitation: the lack of HAM mode support. If you wanted to create 4,096 colour pictures, then you had to use something like *Digipaint* or *Photon Paint*. Now these programs are all very well, but the problem is that they ONLY work in HAM mode, so you can't create standard 32-colour pictures or work in high resolution.

Now those days of swapping from program to program to create artwork will disappear thanks to *Deluxe Paint IV*. The latest version of Electronic Art's superb art package not only gives you the ability to create and animate HAM pictures, it also supports all the other screen modes, including super-bitmaps and overscan screens.

In theory, this ability should make *DPaint IV* one to watch, so let's have a look at some of the new goodies.

## PAINTING

The ability to work in all screen modes isn't the only refinement that *DPaint IV* has to offer. There's much more. Much MUCH more. A number of the changes have been implemented to allow you to get the most out of HAM painting, such as improved colour mixing and a rather ingenious way of creating colour ranges.

Mixing colours can still be done via the old red, green, blue values and hue, saturation, valence sliders to create shades, but when your working with a 4,096 colour palette this may

This coloured picture of King Tut shows just what is possible with over 4,096 colours at your disposal. Just think, people were amazed by the original a few years ago!

FAR RIGHT: Using HAM mode, this picture combines a Mandelbrot, a fractal landscape and a tint to stunning effect.

This retrospective work shows the developments that *Deluxe Paint* has gone through over the past six years.

What better use of the Contour fill than to draw a map? This shows the subtle shading and colouring effects that are possible with this simple to use system.

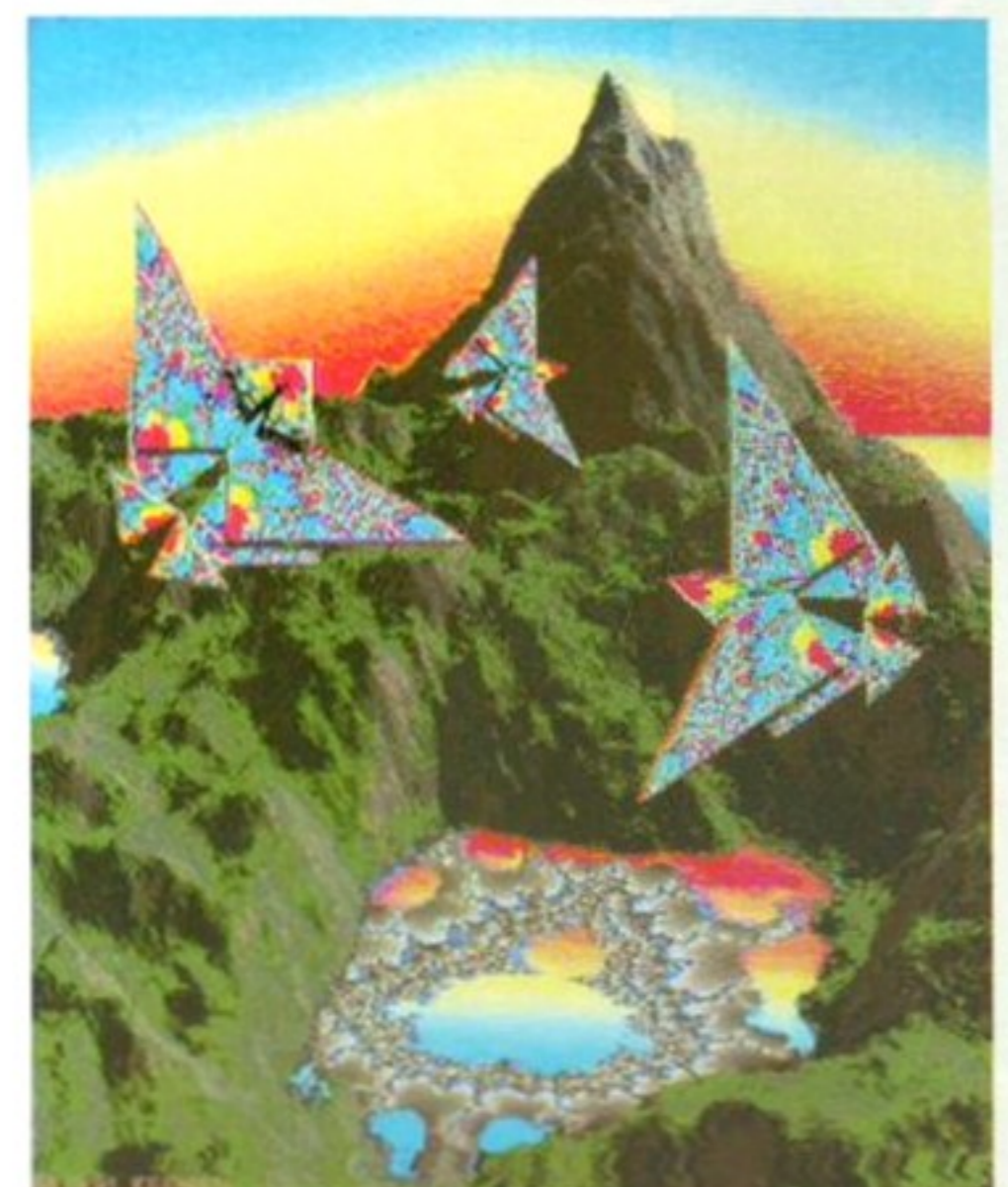
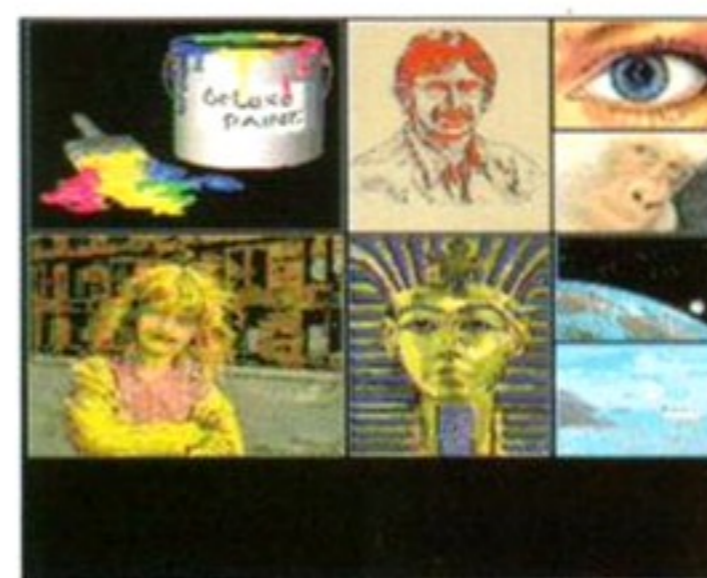



not be enough. What you can now do is draw colours directly on a mixing plate to create a new shade and plonk it wherever you want in your palette.

Setting colour ranges is far more friendly on the new version. Instead of just marking start and end points within your palette, you take your start and end colours from anywhere and place them on a range bar. The program then takes the start and end points and picks the required number of in-between shades to create the range.

Another useful point worth noting about the new palette and range control is that you can mess around with them and still draw on the screen with the windows active. This means that you can test out your dabbling before your committed to using the settings.

So once you've got your colours sorted out and your ranges set up, what can you do with them? Well *DPaint IV* has taken the idea of gradient fills and gone berserk. As well as

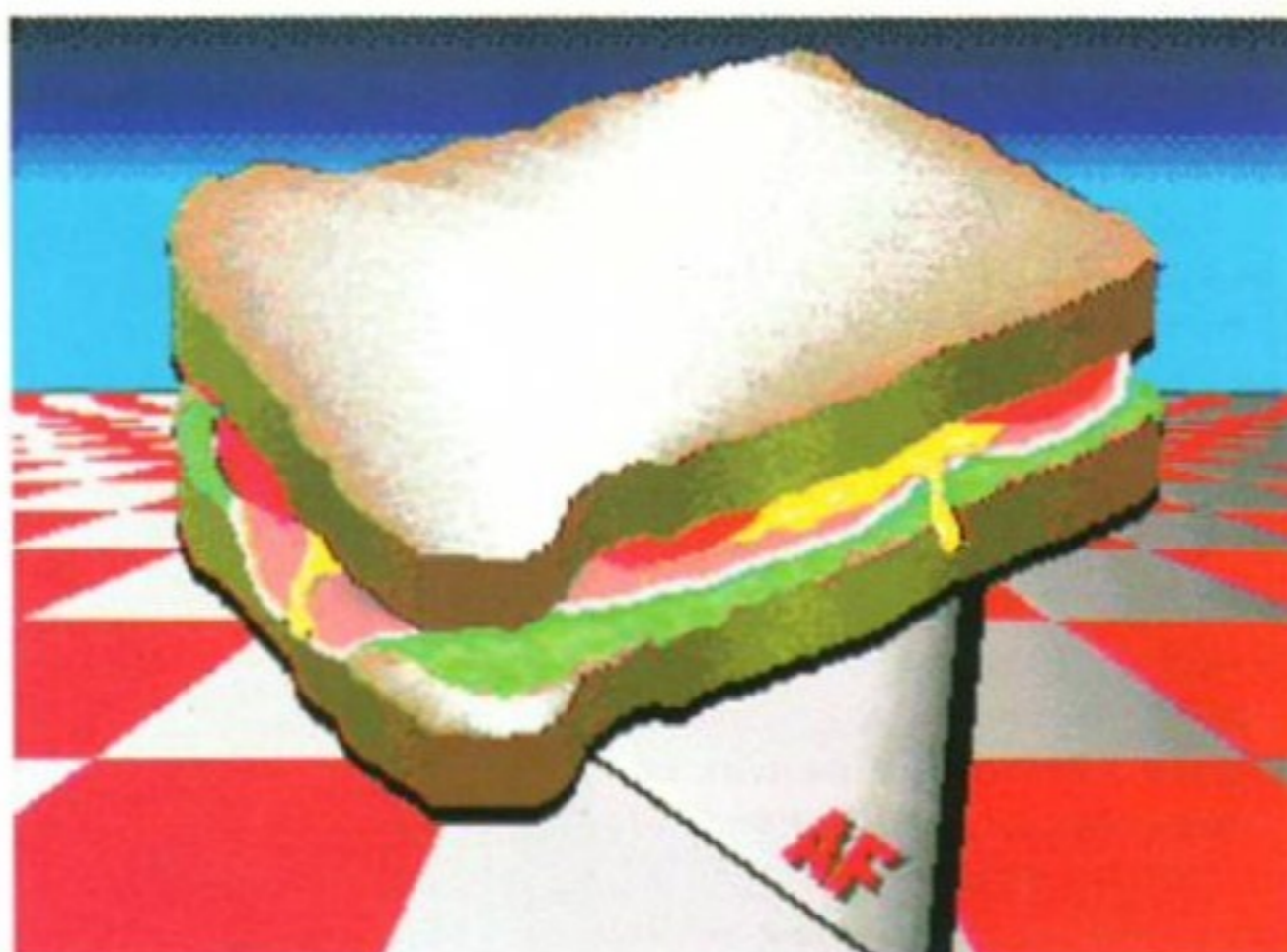

**HAM SANDWICH** The main feature that previous versions of *Deluxe Paint* lacked was a HAM option. *DPaint IV* features HAM painting and animation, with a range of new tools to make use of 4,096 colours.



**MIX AND MATCH** As with the earlier versions of *Deluxe Paint*, you can create colours by altering various sliders. In addition to this, there is a Quantel-like mixing panel, where you can scribble blotches of colour over others to create new shades and place them where you want in your palette.



**LONG RANGE TARGETS** To allow the artist to get the maximum effect from the subtle shading possible in HAM mode, a new method of creating ranges has been introduced. Instead of bracketing colours in the colour-mixing section, you can now create up to eight ranges using colours from anywhere in the palette to create colour gradients.

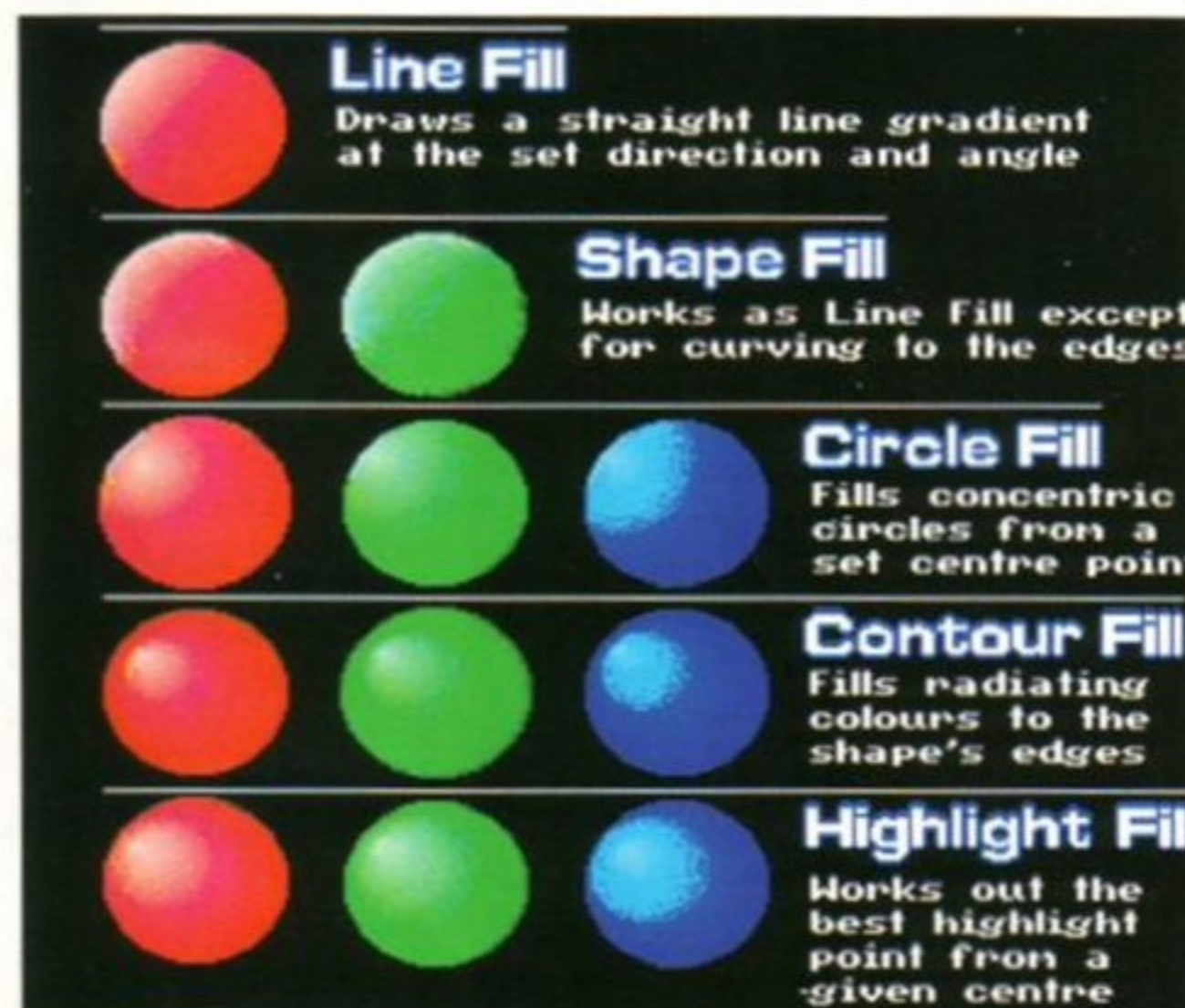

**MAKING THE GRADIENT** You can now create strange shading and shaping effects using a host of new gradient tools. These include line shading, shape filling, concentric circle-fills, contour effects and highlighting. By setting a range, you can use any of these modes to create spheres, curves and reflections with ease.

horizontal and vertical gradient fills, you can create line shading, contour gradients, highlights and concentric circle fills. All these effects are created by taking the filled shape you draw and calculating the positions of the edges. It then uses the current range to create a graduated tint across the surface of the shape.

Right. So you can create smooth ranges and use them for special gradient fills. What else?

Well this is just the tip of the iceberg. You can also carry out what are called Process Effects. By selecting an option from the PROCESS menu, you can tint areas with a new colour range, change the hue of on-screen colours or make areas darker or lighter. Another effect new to *DPaint IV* is Translucency. This allows you to draw or place brushes over the current picture so that the colours appear to be partially transparent.

One system that regular custom-brush users may find interesting is the fact that you can store two brushes at the same time. By selecting 'BRUSH -> SPARE' from the BRUSH menu, you can put the brush you've just picked up into a 'temporary' storage bank. You can then pick up another brush and use it until you want to use the original again, at which point you just call up BRUSH <-> SPARE to swap the old brush with the current one and Bob's your Uncle! It's there ready for you to use again.

Want some more effects? Well how about automatic anti-aliasing for smoother lines and intelligent colour-mixing as you paint for starters. In fact there are almost more painting effects than you can shake a stick at! The only problem is that the new effects take a lot of processing for the program to work them out. In HAM mode, carrying out any kind of processing, perspective or gradient operation takes an age. If you're going to be using *DPaint IV*'s special tints, fills and effects for professional work, then an accelerator card is almost a necessity. Still, with patience the results yielded from the long waits are usually very impressive.

## ANIMATION

Painting effects aren't the only thing that have been added, revised and updated on *DPaint IV*. The animation section has also undergone a fair amount of improvement.

Animpainting (a system of automatically flipping frames of an animation as you paint) has naturally been carried over from *DPaint III*, but whereas the original version only carried animpainting for animated brushes, *DPaint IV* gives you the ability to carry this out by simply holding down the Alt key as you draw. Using this method, you can create linear movements by simply picking up your brush, selecting a dotted line from the straight line options and holding down Alt as you draw the line. The program will then automatically flip through the frames pasting the image on each screen as it goes.

Controlling animations is a much easier process too. Instead of only having play, frame edit and so forth available as key presses or a pull-down menu item, you can now call up an

**Continued Overleaf**

animation control panel. This contains all the frame-editing and action functions, including controls for a new feature that cartoon animators will find invaluable – a light-table or ‘onion-skin’ effect.

The light-table shows other animation frames behind the one you are working on, allowing you to get movements in your clips smooth and precise. By clicking on various options, you can view the previous one or two frames, the scratch page behind the current screen, or make the alternate image dimmer so you can see exactly what’s going on.

Most of the functions are similar to those found in *DPaint III* apart from a few refinements to make animation operations more fluid. For a start, a new method of ‘intelligent’ cursor control has been incorporated in the move requester for a start. This means that once you’ve entered a value in one of the distance or angle windows, pressing return automatically moves you on to the next window. Much simpler and much appreciated!

**A MASTERPIECE OR A DAUB?**

Seeing as *DPaint III* was such a massive success and widely acclaimed product, any attempt to update or improve it is bound to have to live up to some high expectations and a substantial amount of excitement. When the news of *Deluxe Paint IV* hit the streets, with its promises of improved colour handling, increased animation power and ability to tackle any mode including the mighty HAM beast, a fair few Amiga artists wet themselves with glee. So now that the full product has arrived, can it hope to match up to the lofty hopes of *DPaint III* fans?

Well, there are a few niggling details. Even though the ability to use *DPaint’s* superb interface with HAM mode, the fact that all the options work so slowly is pretty frustrating. To render a large area with a gradient fill can take anything up to a few minutes!

One of *DPaint III’s* strong features was the stencil. This is also available in its original form on *Deluxe Paint IV* in most colour modes, but the HAM stencil system has been totally changed. The new system isn’t explained too well in the manual, and it gets extremely confusing at times. There is a way around this though which saves the day. Instead of using a colour mask to create the

**As well as retaining the animation and movement systems employed in *Deluxe Paint III, IV* also contains some new effects. One feature which is a completely new method of creating *DPaint Animbrushes* is the ‘Metamorphosis’ option. The function is similar to the ‘Tweening’ system used by professional computer animation systems, where one shape seems to mutate, becoming something totally different. Instead of only being able to use a single custom brush (as in *Deluxe Paint III*), you can store a ‘spare’ brush to use later on. When you select METAMORPH from the menu, *DPaint IV* looks at the spare brush and the current brush and calculates a series of inbetween frames to create a metamorphosis effect (obvious really from the name). All you have to do is pick up the picture you want as the start point as a brush and place it in the spare slot, pick up the picture you want to end at as a brush and select METAMORPHOSIS from the SPARE section of the brush menu. The program will ask you how many frames you want the mutation to run over and then automatically work out the inbetween changes. Once the program has finished the calculations, you will have an animbrush set to the length you want which features the ‘tweening’ effect. Now you can animate it as a normal Animbrush in your own full-blown animation sequences.**



**Video Post**

*DPaint IV* comes with some useful utilities, so that you can make the most of your creations.



In the past, in order to put animations onto your own stand-alone disks you had to either do some pretty hefty coding or splash out on another animator program. *Deluxe Paint IV* has done away with the need to use any other editing system by including a couple of utilities from the highly successful *Deluxe Video III* in the package. By loading the Instant Slideshow editor from the utility disk, you can assemble pictures and animations into a sequence, along with information about how to move from one animation to another. All you have to do is specify

**Moving with the Target**



The new Move Requester features a few refinements. Including the ability to load and save movement paths.

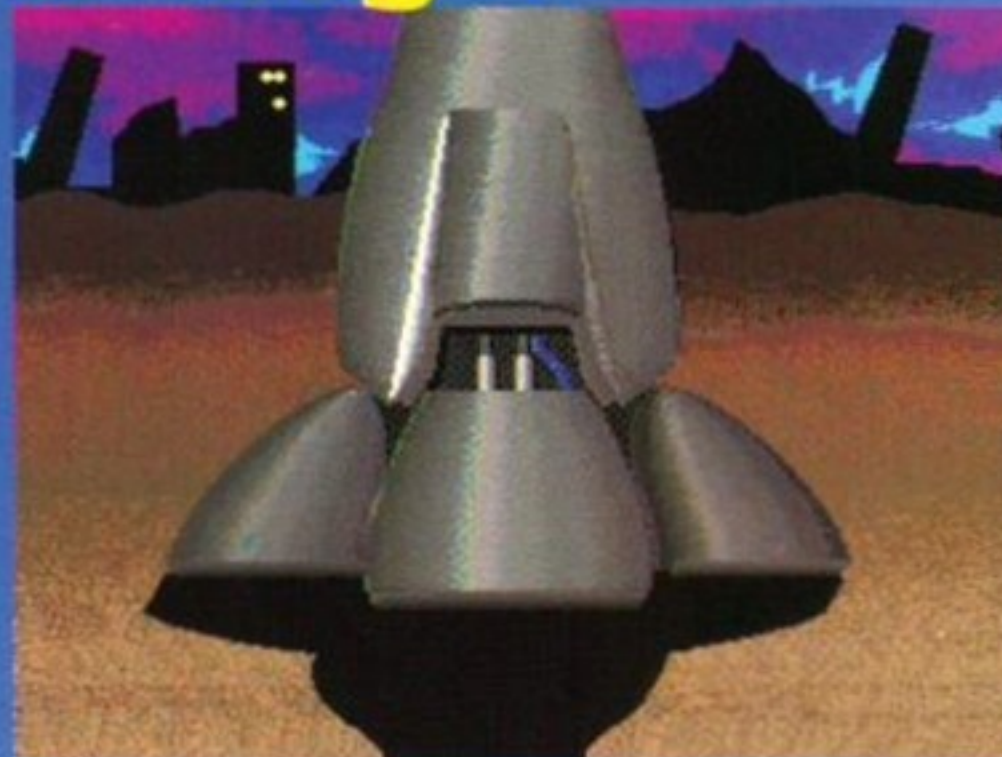

By using the gradient fills, you can create a range of effects, such as mottled backgrounds and metallic surfaces.



Now complex HAM artwork can be easily moved around to create superb animation sequences.



# Production

**RIGHT:** In order to illustrate the Video Player utility, the disk contains this strange clip. The sequence is made up of a series of short animations, which are loaded from disk in the correct sequence to create an entire cartoon.

**BOTTOM RIGHT:** One of *DPaint IV*'s programmers juggles with the complexities of coding HAM mode options (all right! That's enough crap HAM gags - Ed).

**BELOW:** The Instant Slideshow creator, which allows you to run pictures and animation in sequence, so that you can create free-standing demos for yourself.

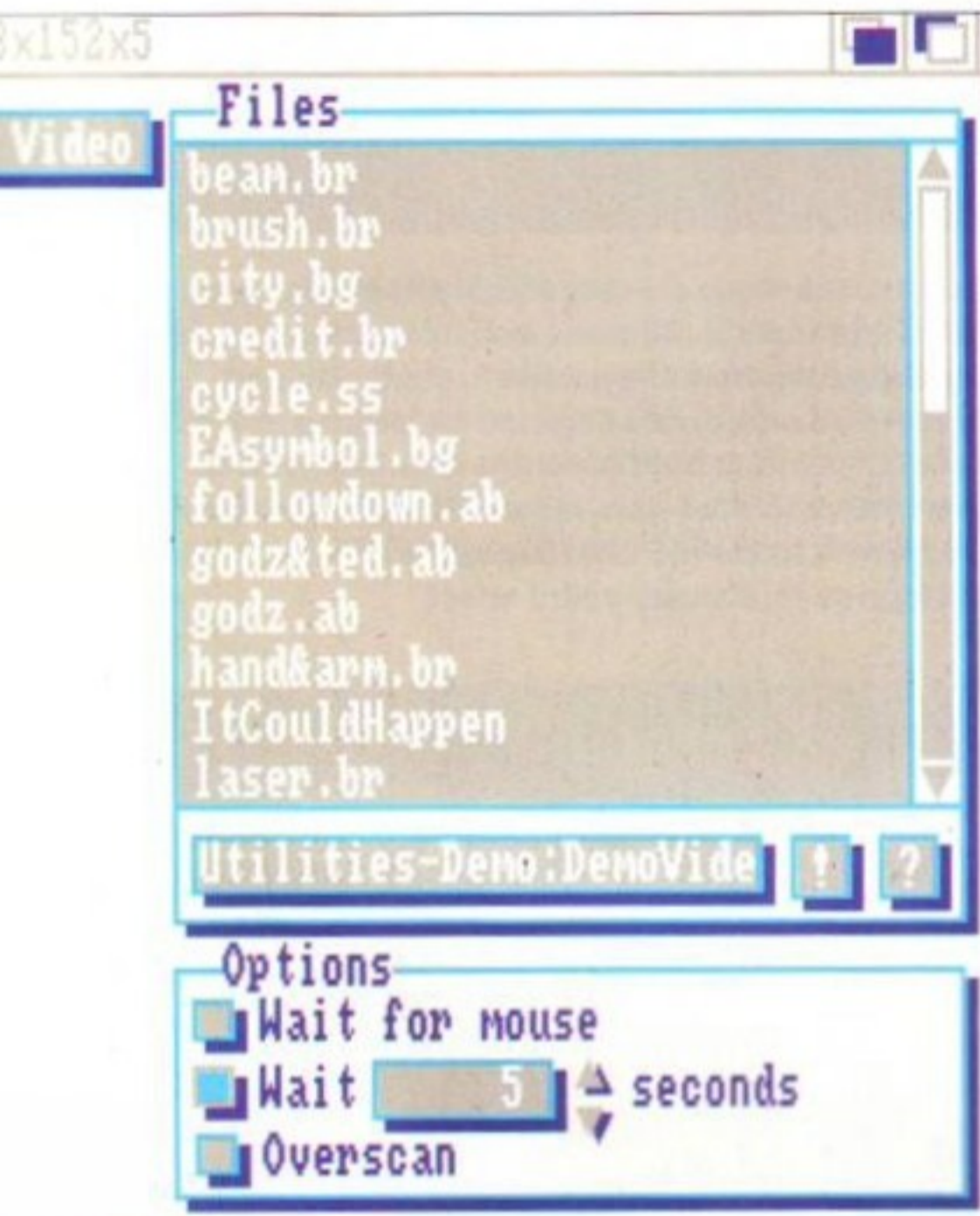

the file names of the artwork you want to use and place them in a 'cue-list' to arrange them in the required order. You can then set the first and last parts to be displayed, the loop position and whether to wait for a button press or a delay before moving on to the next clip. Clicking on MAKE VIDEO will then save the list along with any other information to any specified disk. All you have to do now is copy the pictures and animations to a blank disk along with the Video Player tool and the Video list, make the disk bootable and call up the animation from the Startup-Sequence. There you have it! Your very own cartoon film on a stand-alone disk! Now you can take it around your mates and impress them.

stencil, you can actually paint your stencil on screen by hand. This means that you can mask out exactly the area you want no matter what colour it is. Thank goodness for that!

Another quibble is the fact that the extremely useful blend function (which I tended to use for a whole host of effects in *DPaint III*) has become almost unusable. Instead of creating a smooth blend between colours as you draw, the program takes a while to calculate the required effect, resulting in a strange and particularly non-smooth result.

These few quirks aside, what's the program like to use? Well, putting it simply, *Deluxe Paint IV* is one hell of a program! Everything that was good about *DPaint III* has been carried over along with a whole host of additions and improvements. The new functions are a joy to use, and the ability to use *DPaint* in HAM mode is a dream come true.

The new paint functions, such as the improved colour fills and the impressive new process effects, yield extremely impressive results. By using your imagination and plenty of patience, you will soon be able to create superb pictures with little effort. Couple these functions with the most friendly animation editing system available and you'll be creating excellent cartoons in no time. In fact if you're at all interested in producing Amiga graphics, get *Deluxe Paint IV* immediately!

## Deluxe Paint IV

<b>SPEED</b>	● ● ● ●
In normal screen modes the effects are speedy enough, but HAM operations take a long time.	
<b>DOCUMENTATION</b>	● ● ● ●
Extensive, but such a complex program needs a lot of explaining, sometimes skates over stuff.	
<b>ACCESSIBILITY</b>	● ● ● ●
Users of <i>DPaint III</i> will have no problem adjusting and new users will quickly get going.	
<b>FEATURES</b>	● ● ● ●
The program contains everything that made its predecessor such a hit and much more.	
<b>VALUE</b>	● ● ● ●
A tad expensive, but old users can get a discount and it IS the best art program after all!	

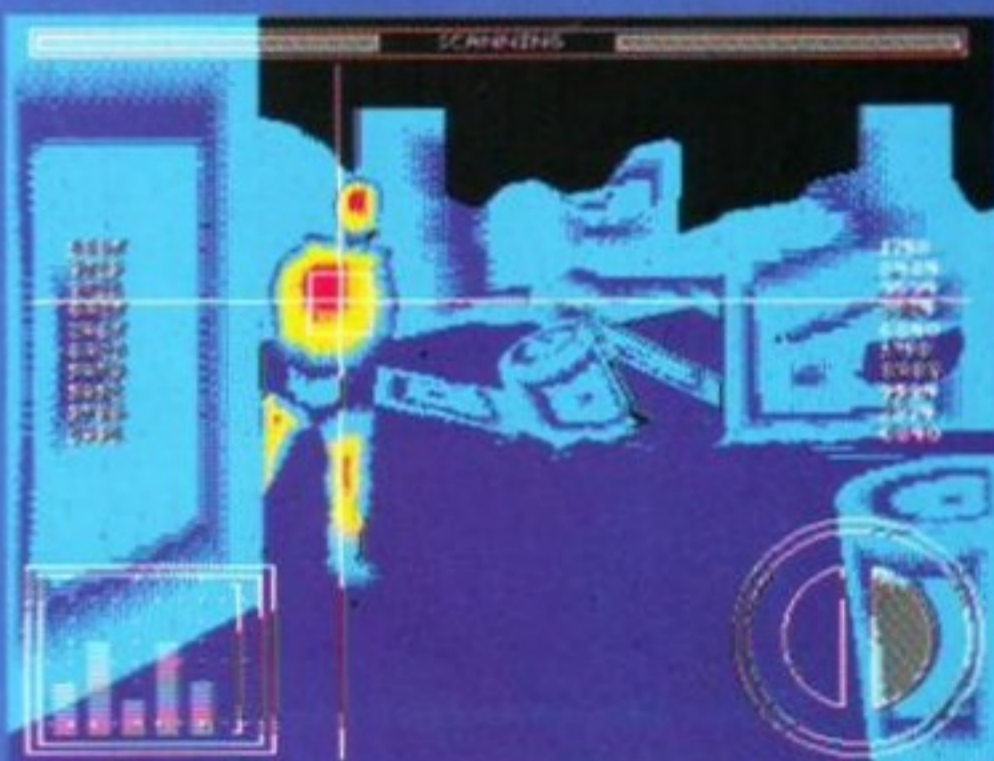

This futuristic Terminator-style animation consists of various sections pasted together and animated in *DPaint IV*.



This robot was drawn and dropped in over the background at the climax of the animation.

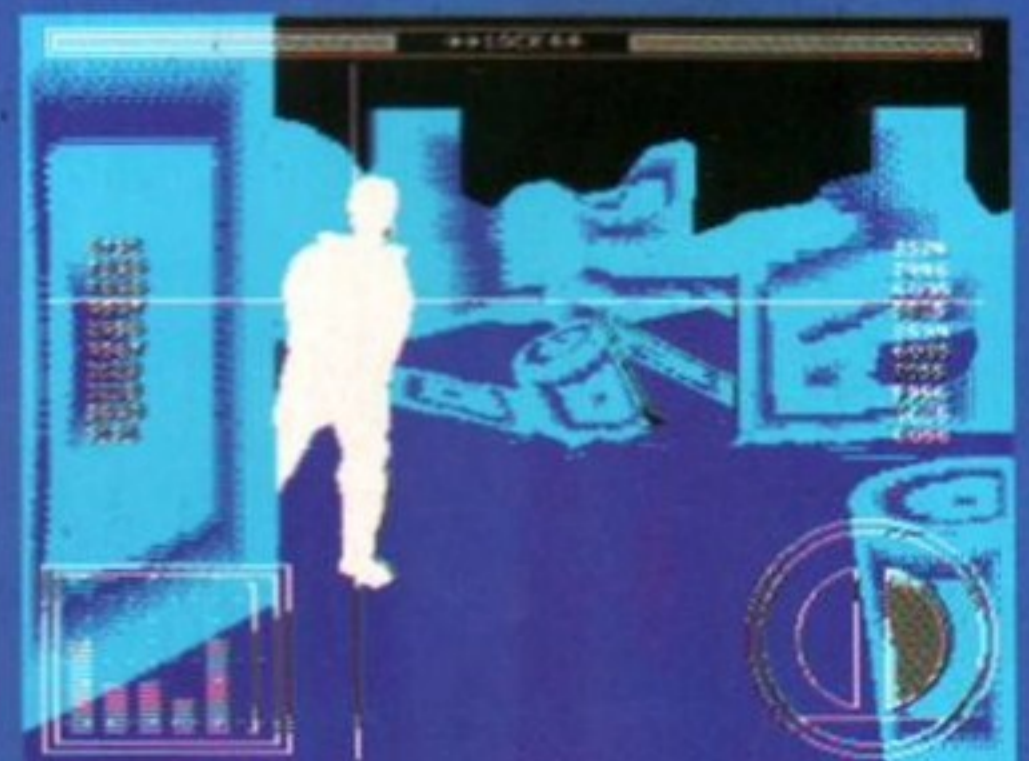

Locked on! What happens next? It's up to you! Try and come up with the end scene in your own *DPaint* animation.

# Getting to grips with Deluxe Paint IV

Are you ready to try it out for yourself? Check out the loading instructions on Page 17, then get in the mood by applying some 'Van Gogh Vanishing Cream' to your ear or donning the end of a mop from the Addis 'Andy Warhol' range of cleaning products. Now prepare to follow **Maff Evans** on a step-by-step tour of the program...

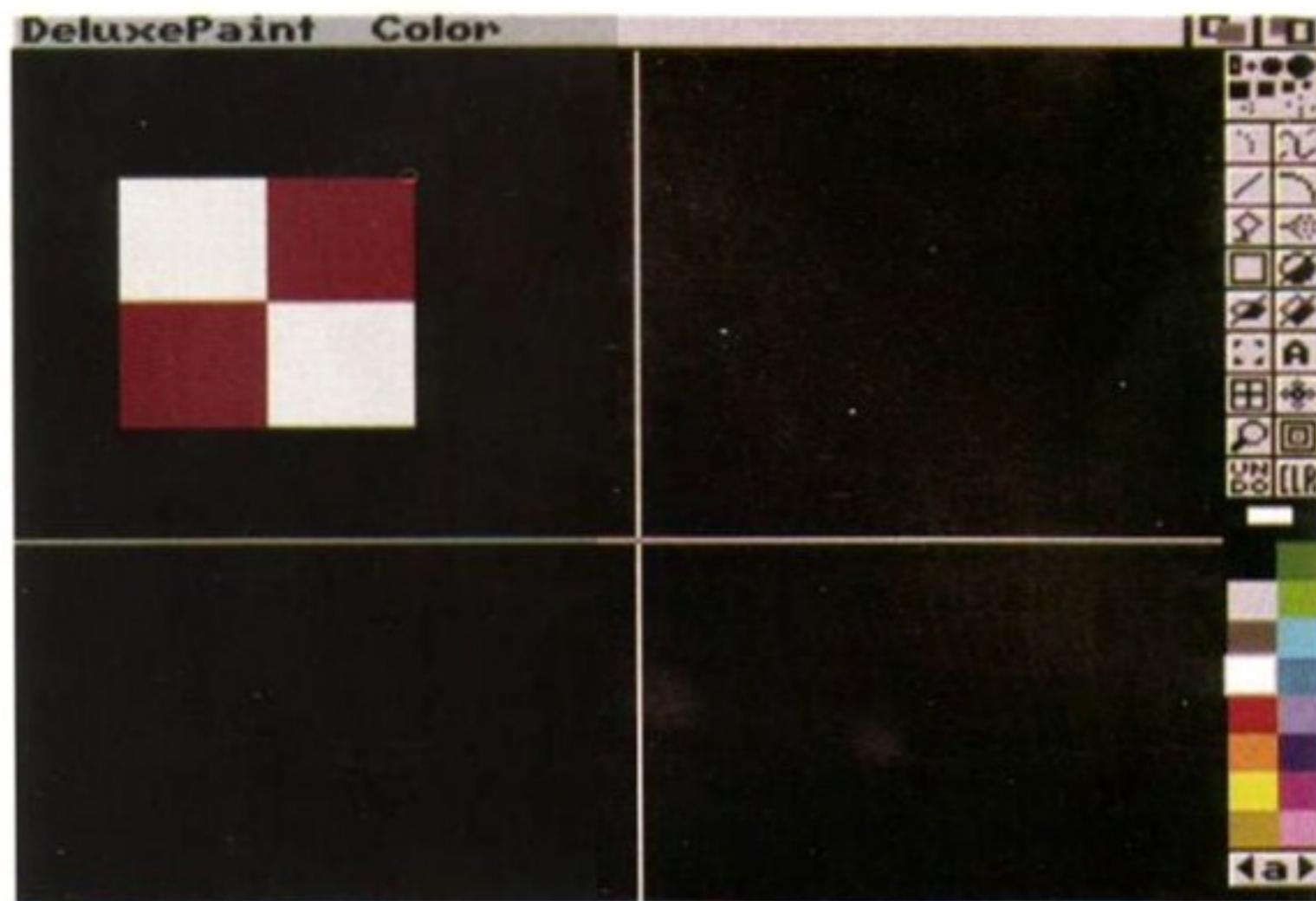

**1** The first screen you get is the mode screen, where you choose what graphics mode you want to work in. Click on the HAM button then hit OK to finish loading. Select red from the palette to paint with and select Filled Rectangle (Filled shapes are selected by clicking in the bottom right-hand corner of their icon). Hold down the Shift key to keep the shape square and drag out a block about an inch square. Select white from the palette and draw a square right next to the red one. Repeat this underneath the first two squares to create a four-by-four chess-board effect.

AMIGA FORMAT

26

SEPTEMBER 1991

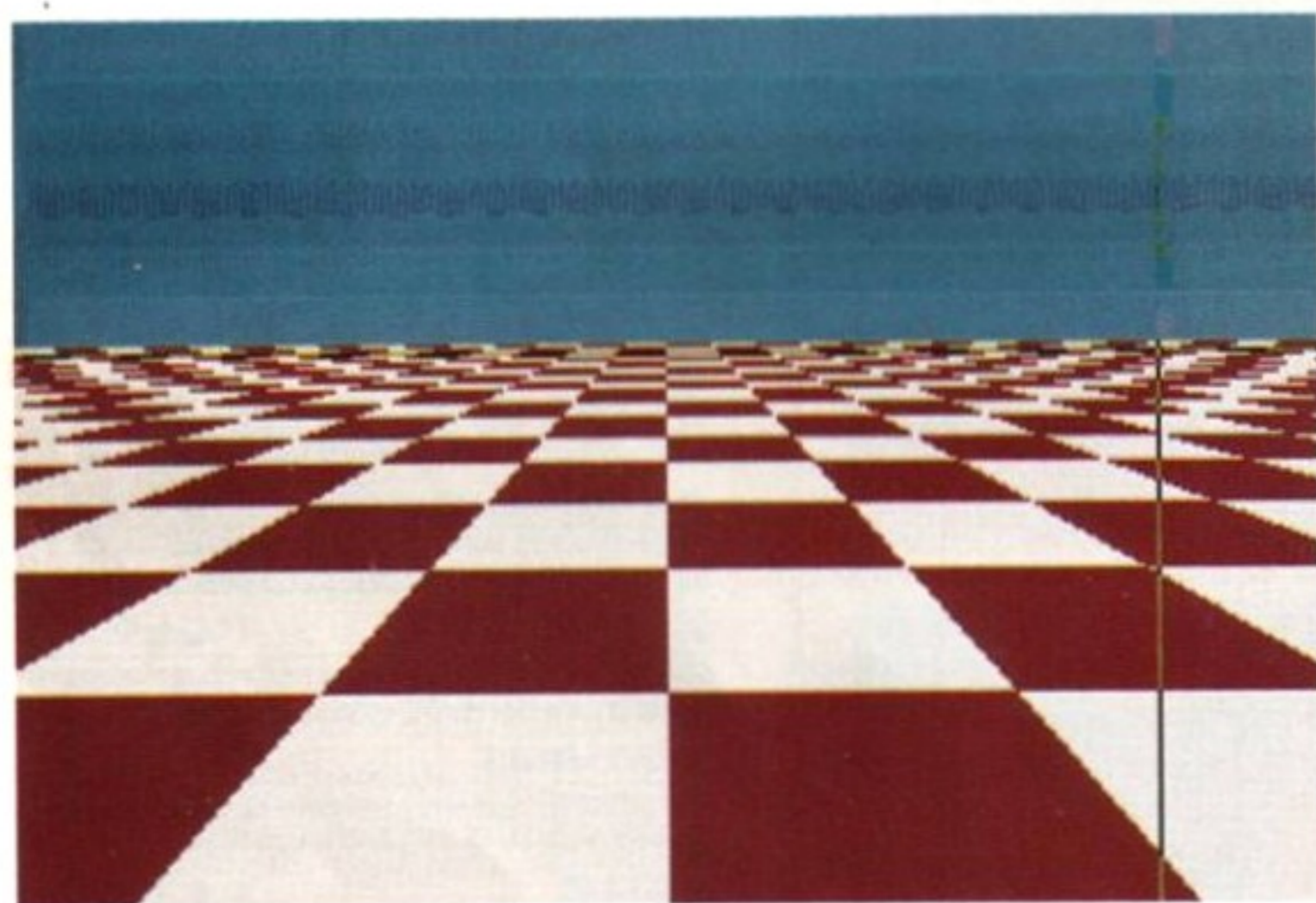

**4** Press F10 to recall the menu bar and select PROCESS > TINT from the EFFECTS menu. Hold one of the Alt keys down and press P to switch the Process mode on. Select Filled Rectangle with the right button to call up the fill options once again and click on SOLID. Click on OK to exit the window. Pick the first blue in the palette and press F10 to remove the menu bar. Draw a block over the rather gaudy sky and wait patiently for it to turn a nice tasteful mottled blue.

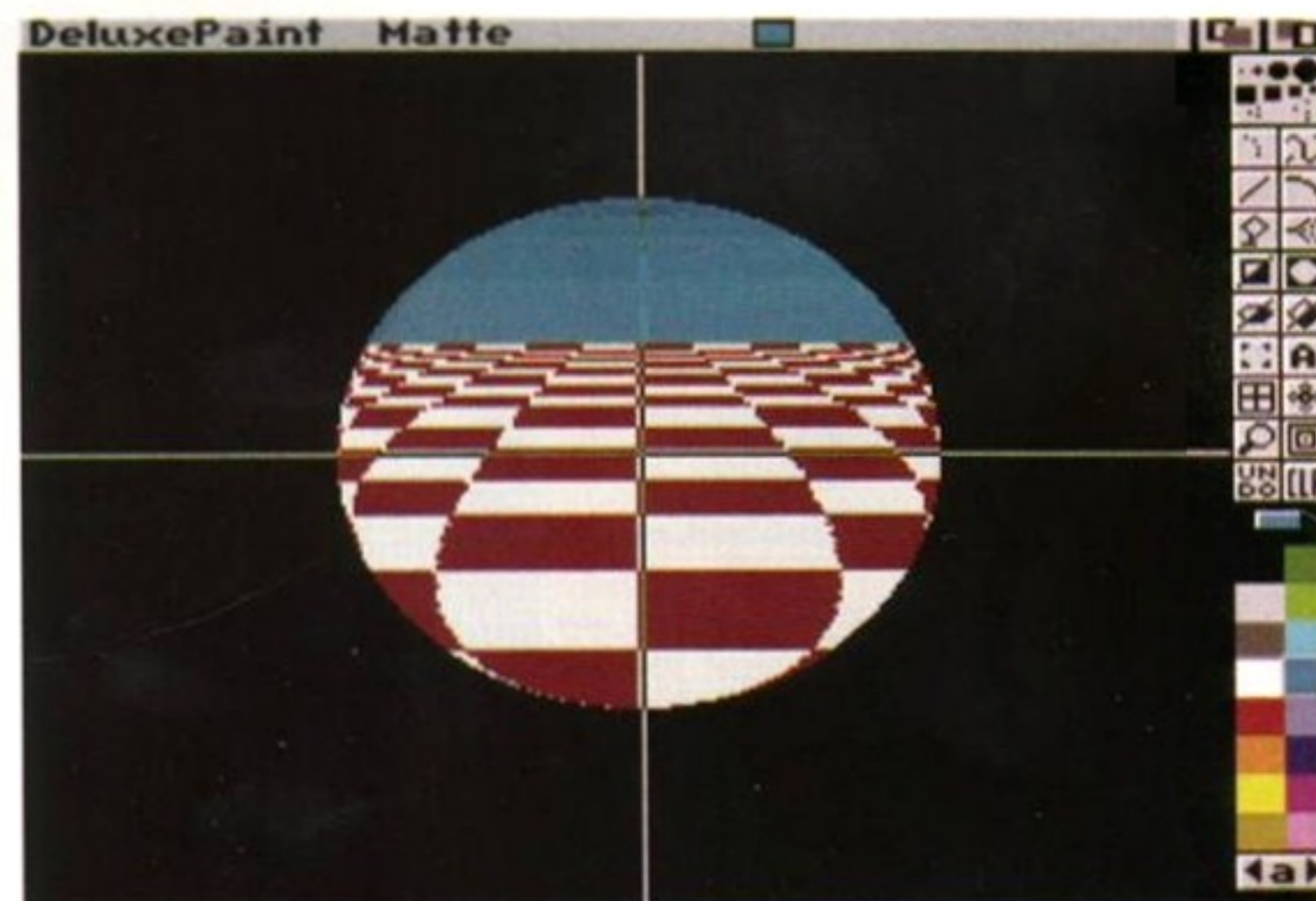

**5** Press F10 to bring up the tools and select Brush Pickup. Pick up a reasonably-sized area from the middle of the screen and press J to swap screens. Click on CLR to clear the screen and press Alt and P to turn off Process mode. Select Filled Circle with the right-hand mouse button, click on WRAP then hit OK. Now draw a circle about the same size as the brush you picked up. The program should now draw your brush wrapped onto a sphere.

## Getting into HAM animation

Now that Deluxe Paint supports HAM mode, you can even create animations using the full 4000-and-more colour palette.

Again, to get a real hands-on feel for how it all works, follow this simple step-by-step practice sesh...

**1**

First of all, we need to force the program to give us a grey gradient. To do this, load up the program as normal and hit

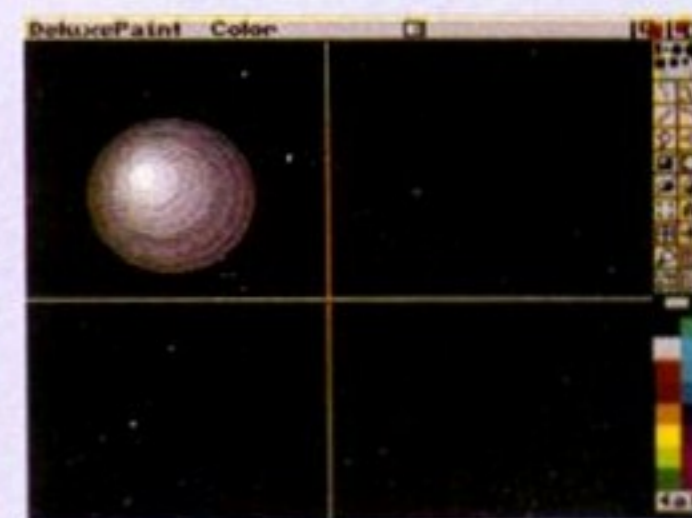

OK to access 32 colour mode. Once the program has finished loading, go to SCREEN FORMAT in the PICTURE menu and click on HAM and OK. The computer will now adjust the colours, giving you a grey-scale gradient to use. Select Filled Circle with the right button, click on CON and hit OK. Now draw a circle about two inches across. When the circle appears, move the end of the line that appears to the top left quarter of the circle and press the left button.



**2** Select Brush Pickup and move to the top left-hand corner of the squares. Hold down the Shift key and drag the box so that it just picks up the four squares. Press J to swap screens, then go to the menu bar and select **PERSPECTIVE > DO** from the **EFFECTS** menu. Move the brush to the centre of the screen, then press 7 on the keypad to the right of the keyboard until the first angle on the menu bar reads -75 degrees. Next select **PERSPECTIVE > FILLSCREEN** from the **EFFECTS** menu and... er... wait.



**3** The top section of the ground looks rather messy, so you'll have to get rid of it. Select filled rectangle again and press F10 to get rid of the menu bar and tools. Draw a block using the right mouse button, starting above the horizon and dragging down to the opposite side of the screen until you've cut out all the messy distant squares. Press F10 to bring back the tools and select Fill with the right button. Click on the button with the up and down arrows then click OK. Press F10 again and click on the black area at the top of the screen to fill it in.



**6** Press J to swap screens and select Filled Ellipse. Move to near the bottom of the screen, about two thirds of the way across, and use the right-hand mouse button to draw a black ellipse that horizontally reaches the middle of the screen. Press the right button to stamp it down and press J to get back to the spare page. Pick up the circle as a brush and swap screens again. Now stamp it down in the middle of the screen so that the bottom of the circle is over the point of the ellipse.

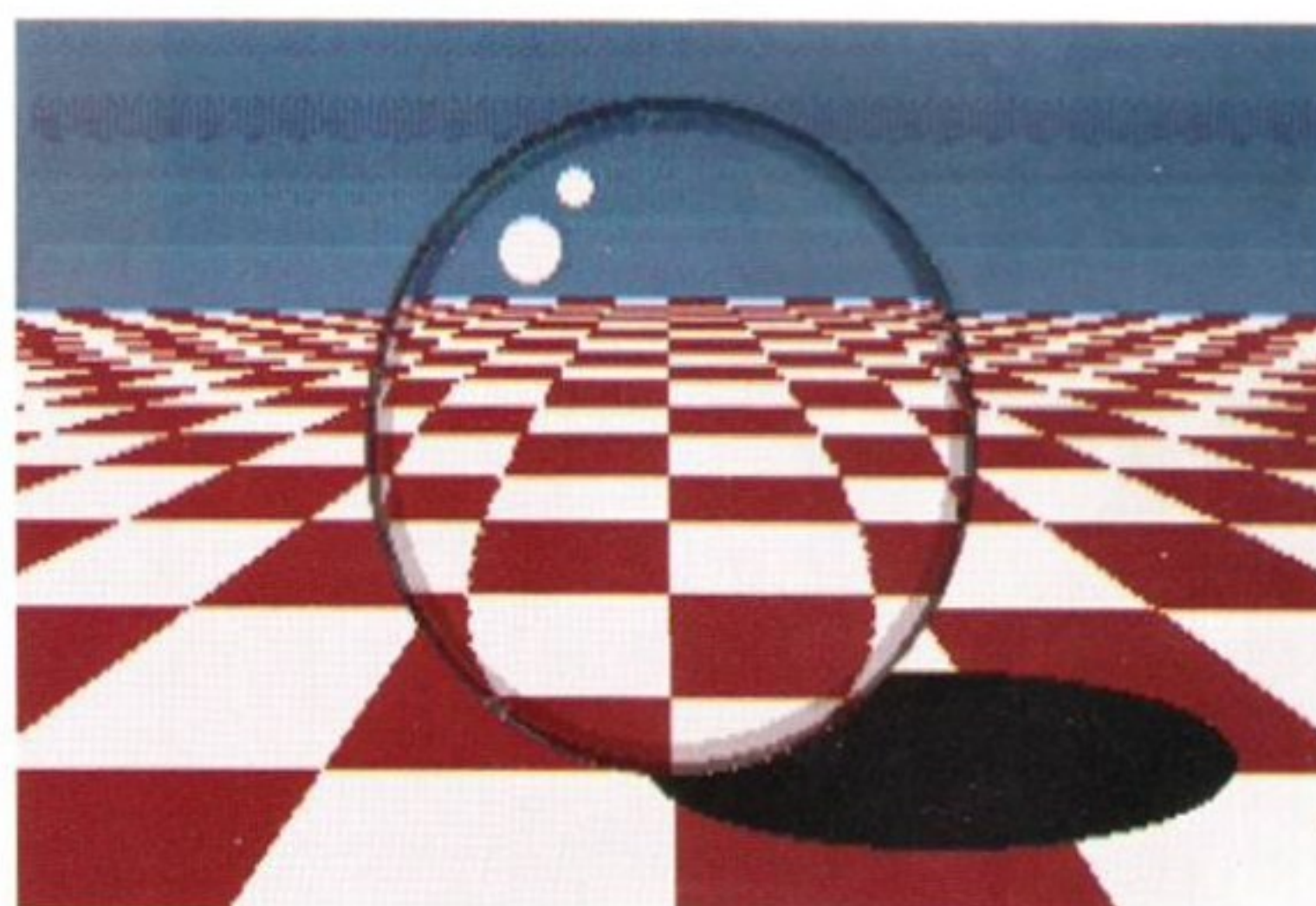

**7** Select **PROCESS > VALUE** from the **EFFECTS** menu and press Alt-P. Pick the thickest round brush and the first grey in the palette and draw an Empty Circle just inside the edge of the wrapped brush you just stamped down. Pick the second thinnest brush and a darker grey. Draw a circle just over the previous circle. For the final touch pick white, select Filled Circle with the right mouse button, click on **SOLID** and OK. Then press Alt-P to turn Process off. Draw the two highlight circles and you're done!

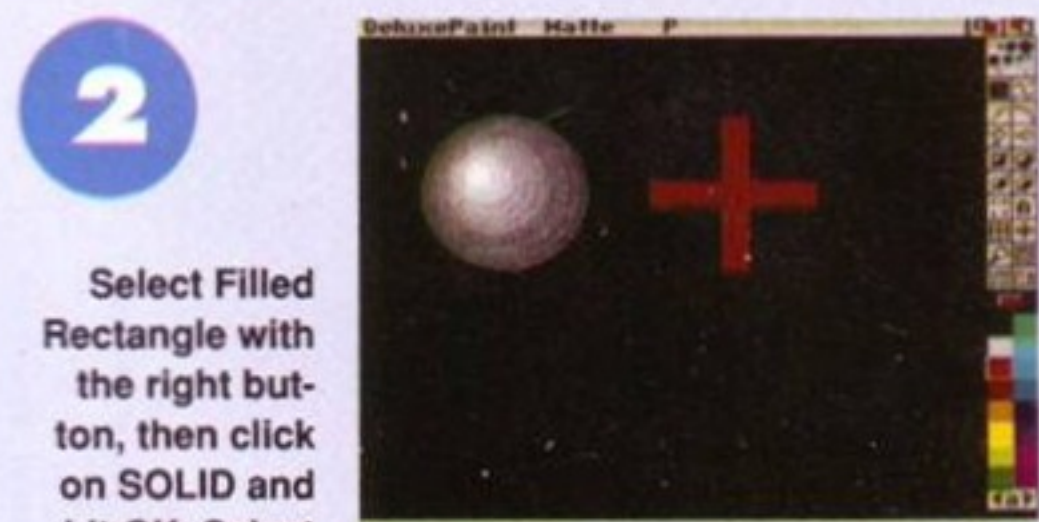

**2** Select Filled Rectangle with the right button, then click on **SOLID** and hit OK. Select red as your colour from the palette and draw a rectangle about half an inch wide and the height of the circle. Pick up this rectangle as a brush and hit Z on the keyboard to rotate it 90 degrees. Place it over the middle of the first rectangle and stamp it down to form a plus-type shape. Now pick this shape up as a brush. Select **PROCESS > TINT** from the effects menu and press Alt and P to turn Process mode on.



**3** Line the brush up so that it is exactly over the circle and stamp the brush down. After a short wait, the program will tint the areas under the brush red, so that you have a picture of a ball with red stripes. Select Brush Pickup and pick up the ball. Be careful to get the brush size to just capture the edges of the ball, otherwise the animation will adopt a strange wobble. Press Alt and P to turn process mode off and hit J to swap screens.

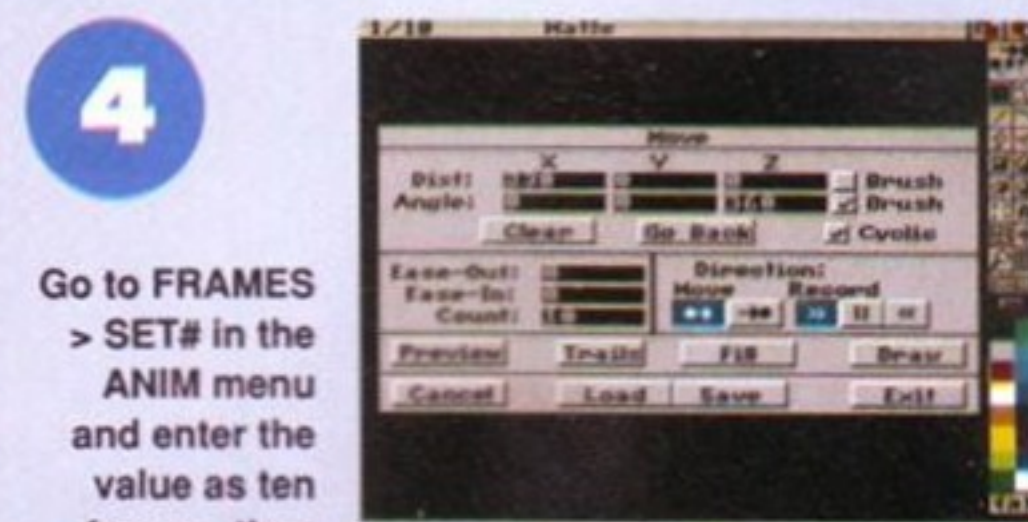

**4** Go to **FRAMES > SET#** in the **ANIM** menu and enter the value as ten frames, then hit OK. Once the frames have been created move your brush so that it just fits on the left of the screen about halfway up and stamp it down. Select **MOVE** from the **ANIM** menu to call up the Movement Requester. Enter the X distance as 230 and the Z angle as 360, then hit **DRAW**. Once the frames have finished rendering (it takes a while, so be patient) press 6 on the keyboard to see your bouncy rolling ball in action!

# HUNTER

## ADAPT TO SURVIVE

The Hunter is alone behind enemy lines. With  
options, and the expertise to complete d  
His only accomplices are the weapons, ve  
dimensional universe; his objective: to attack

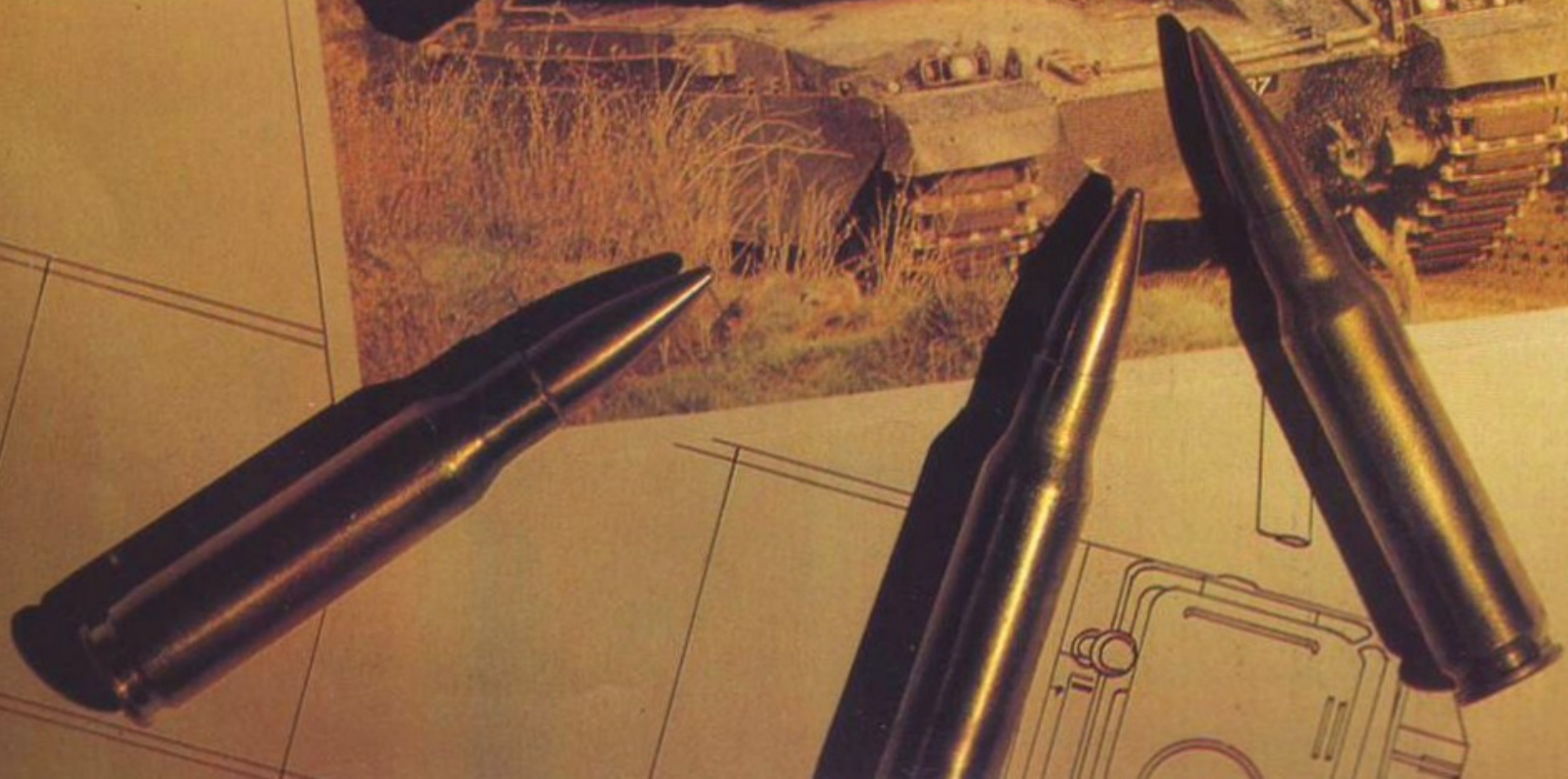
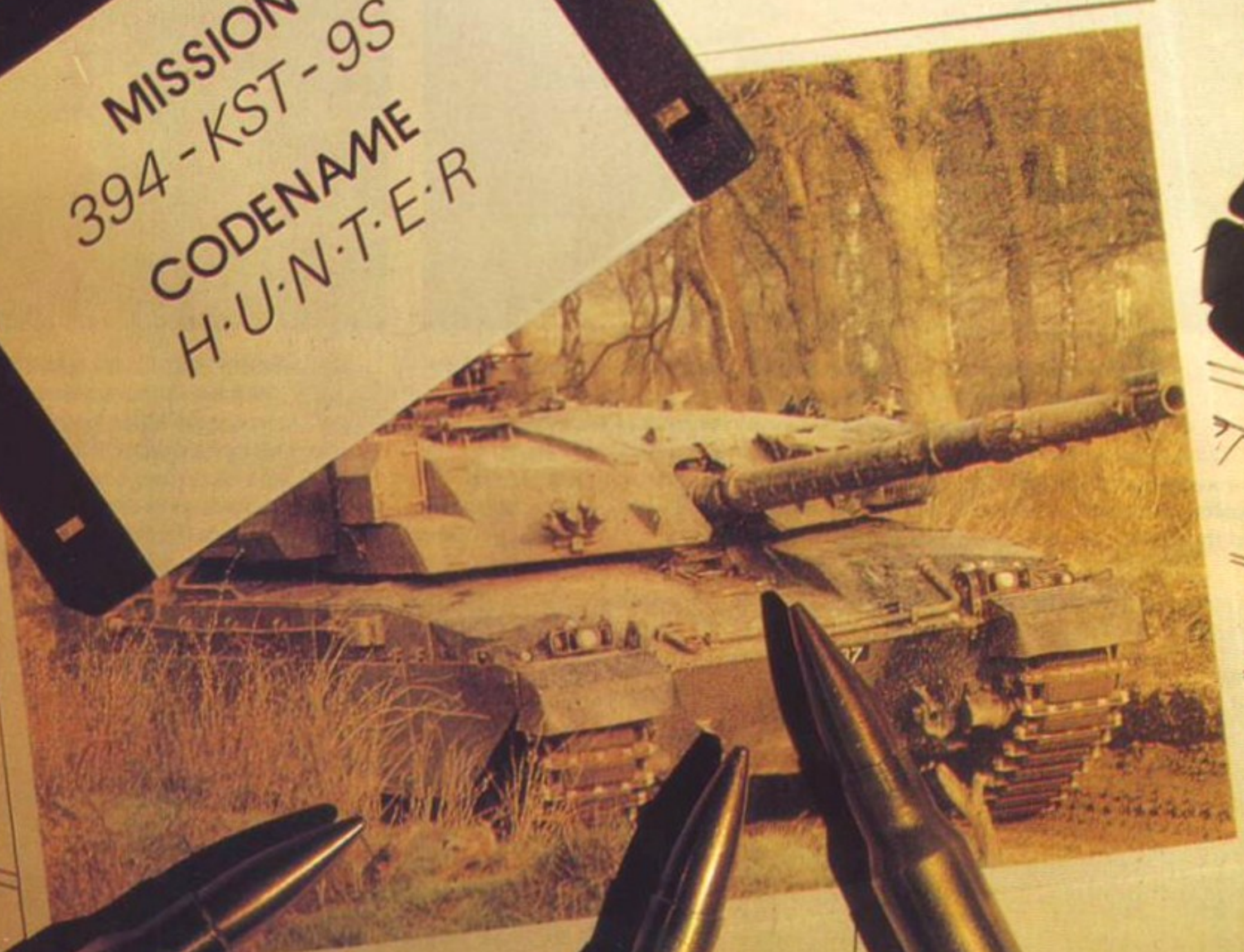
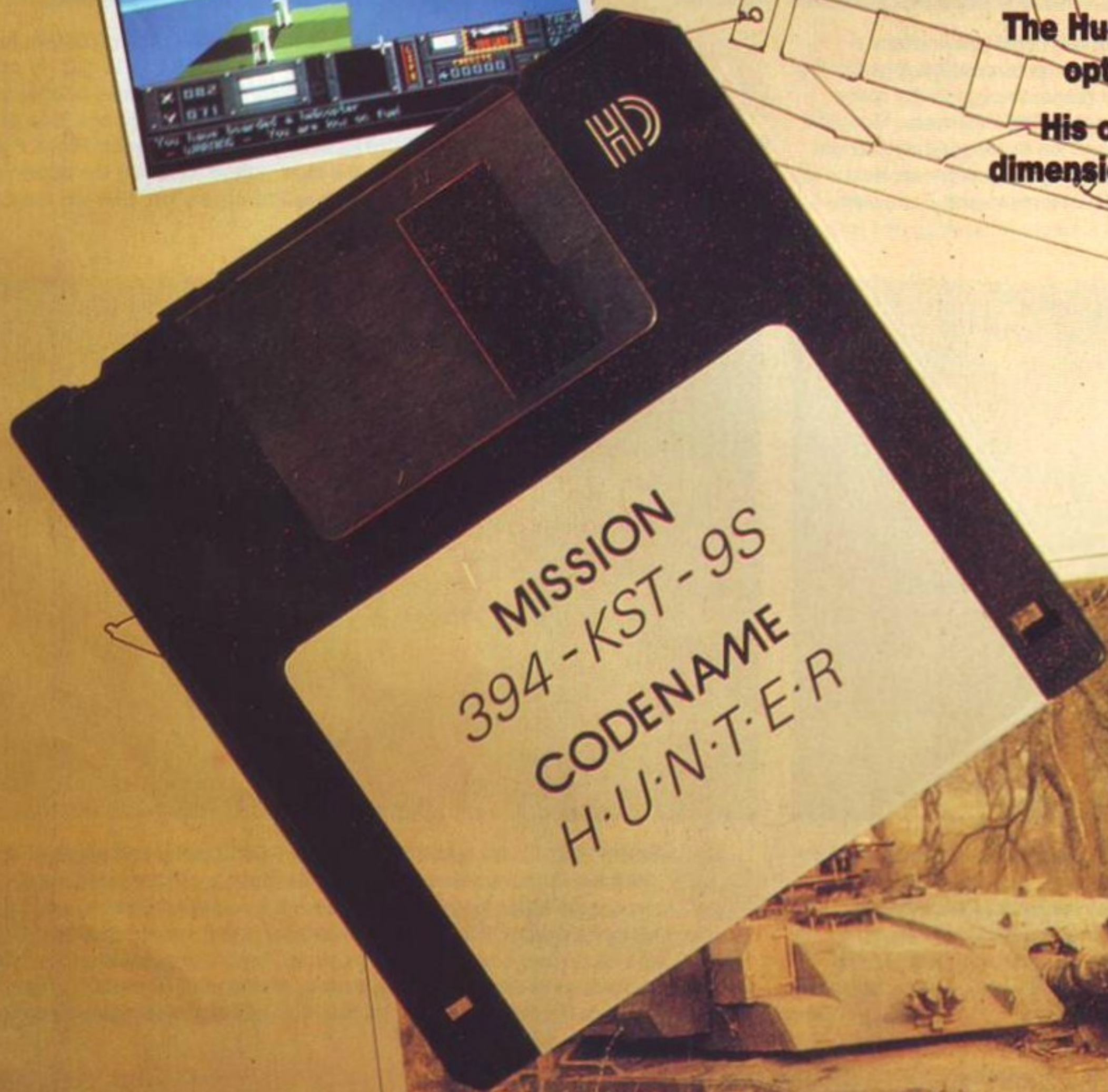
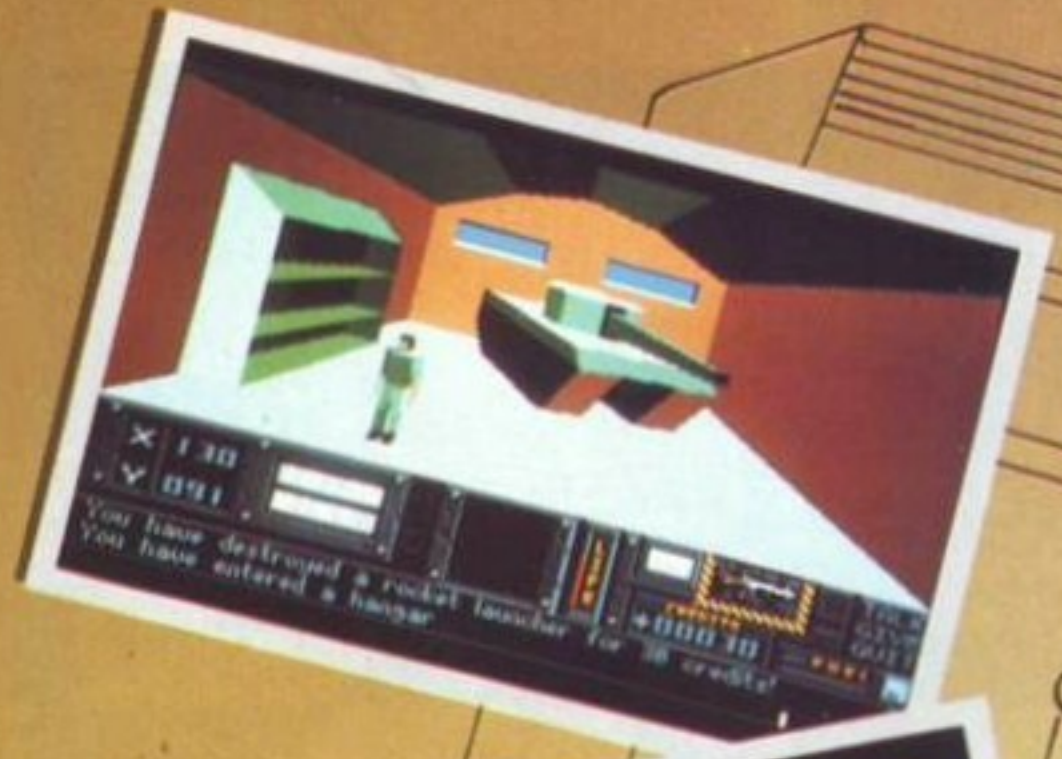

ACTI

# HUNTER

## SEEK TO DESTROY.

versatility to make best use of a wide range of  
ous missions, the Hunter is a breed apart.

s and structures found in his amazing three-  
survive. The Hunter has the will to win. Do you?

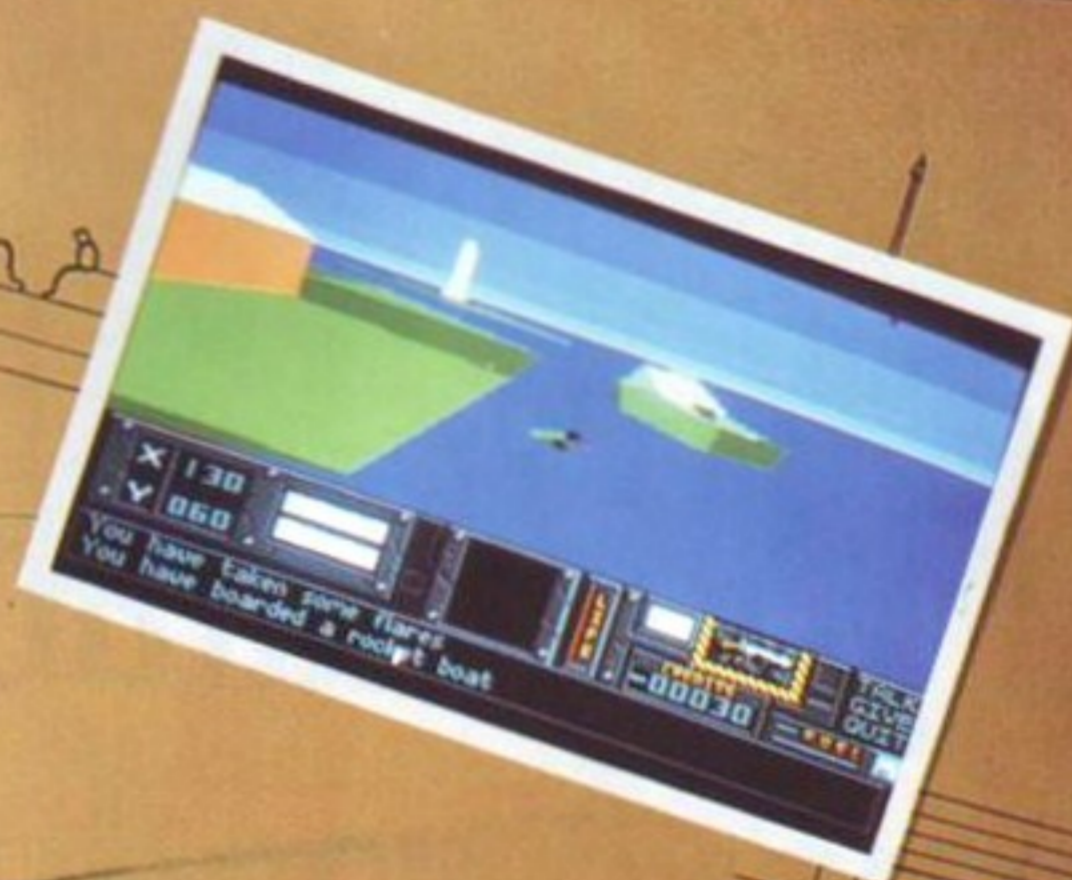
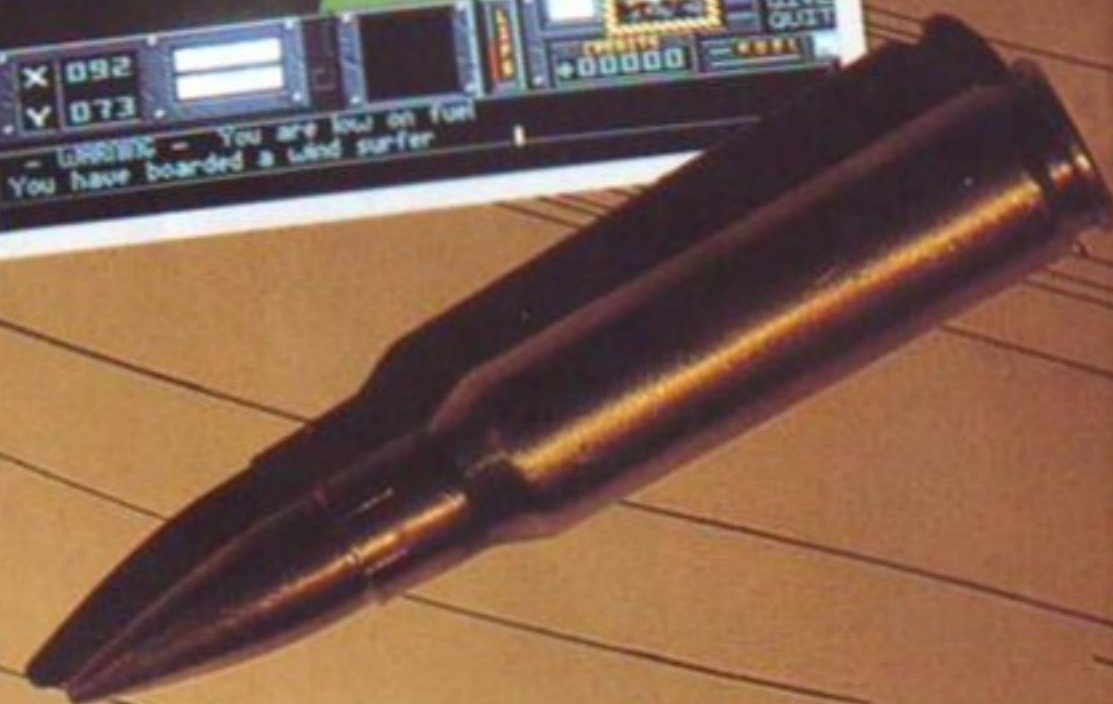

SION

Available in September on Amiga & Atari ST



# If your database looks like this, you're ready to face the future.

Given the chance to gaze at the future of database computing, what would you see?

Graphical applications that are intuitive and yet incredibly powerful, supporting sound samples and even pictures.

Applications like Superbase 4 Amiga.



Unique features like the VCR panel mean browsing and reporting on data have never been simpler.

Superbase's WYSIWYG Form Designer lets you draw and design forms that are easy to understand and use.

And, with its own comprehensive Database Management Language, you can develop professional applications.

You can share data with users of IBM-compatible PCs, while developers can make sophisticated database solutions available on both Amiga and Microsoft Windows platforms.



All trademarks acknowledged. Screen shot taken on an IBM PC.

Superbase 4 Amiga also supports import/export of dBase, Lotus 1-2-3 and Microsoft Excel files.

So, for your future's sake, clip the coupon, send us your business card or call us on 081 330 7166 to find out more about Superbase 4 Amiga. After all, the benefits are staring you in the face.

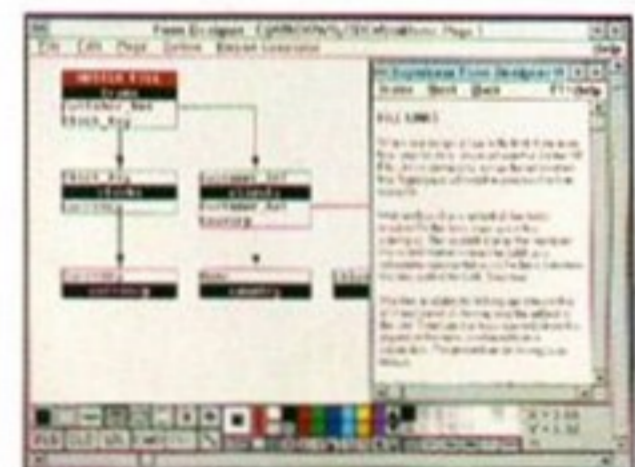

Denote the relational links between the files referenced in your form.

## SUPERBASE® PROFESSIONAL 4

I currently own a copy of:

- Superbase Professional     Superbase Personal 2  
 Superbase Personal        Neither

Name \_\_\_\_\_ Job Title \_\_\_\_\_

Company \_\_\_\_\_

Address \_\_\_\_\_

Postcode \_\_\_\_\_ Tel \_\_\_\_\_

Precision Software Ltd. 6 Park Terrace, Worcester Park, Surrey KT4 7JZ.  
 Tel: 081 330 7166 Fax: 081 330 2089

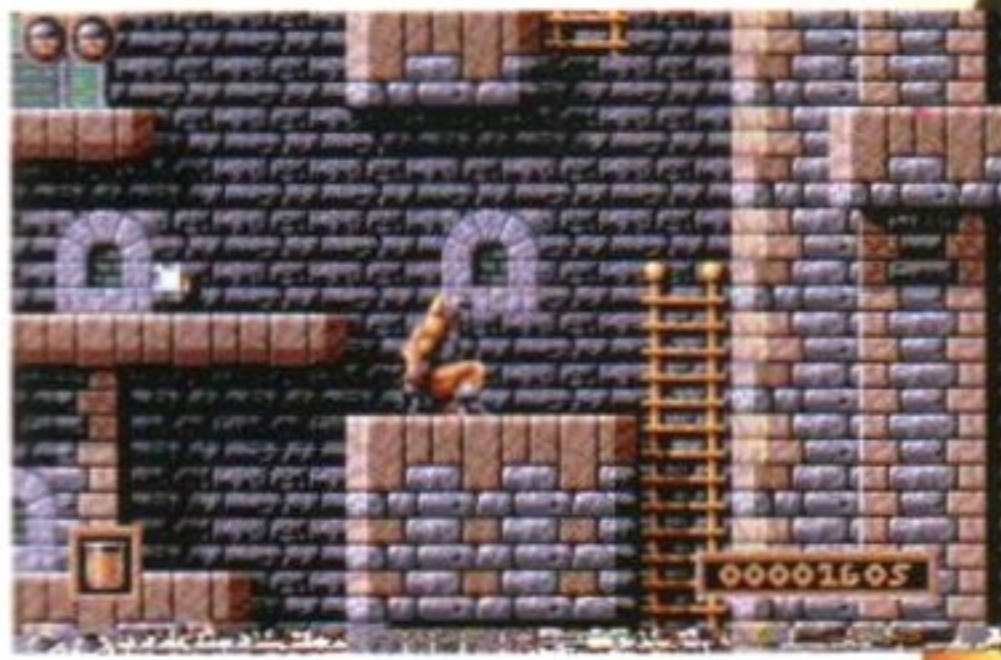

Ever listen to some really good game music and wonder how it was created? Ever heard something really average and thought "I could do better than that"? Now's your chance to learn the secrets and try it yourself, as **Damien Noonan** persuades top pop star programmers The Bitmaps to spill the beans...

**THIS MIGHT SOUND** like a right old pile of pigeon droppings to you, but I reckon the top games programmers are artists. That's right, artists. Why? Well, if you think about the kind of skill, inspiration and humour that's gone into the graphics, the animation and the gameplay of something like Lemmings or The secret of Monkey Island, you're up there with the best cartoonists and film-makers. Hell, there ought to be Amiga games Oscars!

If there's one field of game-making that's particularly open to an injection of artistic talent, it's the music. Yet music often gets left out of the limelight nowadays. In a sense this is quite right and proper, because you decide what games to buy according to how well they play, not how good they sound. But why do people buy games with great graphics and very little gameplay when they don't buy games with great sound and little gameplay?

Good music and sound effects can add an awful lot to a game. The best music is appropriate to the type of game, adding atmosphere and intensity, making a shoot-em-up hectic, a platform game jolly and an adventure dark and mysterious. And music can also give clues to

**SHADOW OF THE BEAST** was a pretty average platform game but with amazing colourful graphics, so lots of people bought it.



**MOONSHINE RACERS** was a pretty average driving game with the most amazing banjo music, but it wasn't so popular. Why do graphics sell games when music doesn't?



## Making Music with the Bitmaps

the player about what to expect, actually enhancing the gameplay: such as the ominous chords that sound as you finally approach the tender mercies of the end-of-level guardian.

But above all, if you don't keep an ear out for the latest in game music, you're missing out on the work of a talented bunch of people who are showing off the amazing Amiga's abilities. Let's find out how they do it...

**The Bitmap Brothers** have always been known as 'the pop star programmers', perhaps because they insist on wearing sunglasses every time someone points a camera at them. But there's two very good reasons why they have now earned the title that was once a friendly jibe and can wear it with pride.

First reason, their soundtracks. Thanks to a unique tie-in with record label Rhythm King, each game The Bitmaps have released on their independent label Renegade has featured a music track adapted from a song by a top band. It all started with the Bomb the Bass soundtrack for *Xenon 2*, and if you think it will end with the Betty Boo track that accompanies *Magic Pockets*, you're wrong.

Second reason, their attitude. The Renegade label was set up to give the people who create the games full credit – as artists – for what they do, in much the same way a band gets the credit for their music or the actors and director get the credit for their film. Which naturally kinda commits them to doing something pretty darned good and using only the best people in every aspect of their development work, including the music.

So who better to get to explain the ins and outs of creating game music than the man who created the Renegade sound, the man behind what is widely accepted to be some of the best in-game music ever made, the man who put Nation 12 into *Speedball 2* and Betty Boo into *Magic Pockets*.

Richard Joseph is a professional musician who just happened to find his way into the computer games scene in the day when the Commodore 64 was a pretty cool machine, and has since earned a reputation as one of the best. He doesn't just work with the Bitmaps – you'll have heard his wild banjo music on *Hillbilly Moonshine Racers* for Millennium, his atmospheric reworking of Jupiter from Holst's Planet Suite on *Mega-lo-Mania*, and you will soon hear his mediaeval pipes and lutes putting you in the mood for Millennium's *Robin Hood* film conversion from.

But when he's working with the Bitmaps on a soundtrack like the *Magic Pockets* one, featuring a famous chart song, Richard has a distinct advantage. He is given access to the

**BOMB THE BASS**



**Megablast (On Precinct 13) was the soundtrack for Mirrorsoft's Xenon 2, produced by The Bitmap Brothers and programmed by The Assembly Line. Tim Simenon of the band actually went back into the studio to record a special remix of the track for the CDTV version of the game, where naturally it is on full hi-fi quality audio.**

**SNAP**

**This German club music band have their studio in the same building as Demonware, so it was natural for their rap-dance songs The Power and Oops Up! to be plugged into the games of the same name.**



original studio tapes of the song he's converting and sometimes even the samples themselves. "For the Betty Boo thing I have the studio 24-track on DAT (compact digital tape, if you haven't heard of it before) with all the samples separately." He has, and he's brought it along to play to us.

It's quite weird hearing a tiny snatch of piano, a James Brown sample or a ten-second burst of Betty Boo singing unaccompanied and knowing that these are the pieces from which that Betty Boo song you've heard on the radio was made up. But that's the way it's done: and that's exactly the way you do it on the Amiga, too. The Amiga has the amazing ability to work with samples, slices of music or noise stored as digital information in the computer. This ability puts it up there with the latest in music technology, and lets you use the techniques that made Acid House and many other modern styles possible.

"It's quite amazing what you hear on the studio tapes sometimes," says Richard. "Very often there's lots of things in there you never normally hear on the record." Sometimes Richard is even luckier than having the studio tapes: when he's working with Simon Richards from Nation 12, as he did on the *Gods* soundtrack, he actually gets the guy's original samples on disk. They're all done on a Macintosh and can just be transferred straight across to the Amiga as computer data.

But with the Betty Boo tape, the next step Richard has to take is to get the samples from the tape onto the Amiga...

# How to play Magic Pockets

The demo of Renegade's latest game is there on the Coverdisk for you to play... but first, you might like a little advice from **Trenton Webb** to help you speed through the game.

The Bitmap Kid has the most incredible, Tardis-like Magic Pockets. They are so massive, he's managed to lose his bike in them. Now, he's going in himself to get it back. The problem is that his pockets aren't filled with the usual small boy kit – sweets, string and fluff – but a huge maze crammed with monsters.

The young Bitmap walks and jumps round his Pocket domain, throwing whirlwinds to catch or kill the nasties, and when he wins through to his bike, he must cycle to the Pocket's exit. He has four lives and as much time as he wants: but the aim is not just to reclaim his wheels, but to get a high score. In a world where an impressive toy-car collection no longer gains kiddie credibility, high scores are important...

## I WANT TO RIDE MY BICYCLE! NOW!

- The arrow shows the direction of the bike so follow it, but not too rigidly.
- When bonus sweets pop out of a cloud they bounce, but you can't pick them up until they've stopped.
- You can kill enemies with shots that go off screen. Listen for the crunching!
- You can jump through platforms, but as BK leaps in a high arc this means an accidental jump can sometimes cause him to contact a beast above him.
- Auto-fire makes the game unplayable, because whirlwinds can't be built up.
- If all else fails watch the demo all the way through and take notes!

## CHILD CONTROL



This is how the Bitmap Kid walks, jumps and does his thang...

Pushing left or right, without pressing fire, gets the Bitmap Kid walking. To jump, press the stick diagonally upwards. To leap vertically, press the joystick straight up.



To initiate a twister press and hold fire. Then, lean the joystick in one of the six directions shown and it will be launched, killing or trapping the first creature it hits. If no monster is hit, the whirlwind will bounce around for a few seconds and then dissipate. There are three different power twisters on offer: the longer fire is held, the more pokey the whirlwind. The power is shown by the size of the kid's pocket and the hand in the lower-right corner.



Large whirlwinds have two uses: jumping and trapping. To use one for jumping, hurl a large whirlwind diagonally down at the floor. Walk into the cloud while it's still spinning and pull down. The Bit Kid will then spin off into the sky. His direction is roughly controllable with the joystick. If he hits anything while spinning he'll kill it, but take care using this technique as the spin can stop suddenly, leaving him vulnerable. Practice this as it is vital.



Beasts can be turned into bonus sweets if they are caught. Hurl a large whirlwind so it lands on any creature that's currently touching the floor. The whirlwind will then surround the creature. Quickly run up and step into the cloud to kill the monster and create a bonus set of sweets. Let them land and scoop 'em up for extra points. If the cloud isn't burst, it simply disappears after a few seconds killing the monster.



To toggle pause on and off, press P. To quit this attempt press Q. Quitting takes you back to the beginning of the demo, ready for a fresh start.



Samples are the key to the way Richard's game soundtracks are made. From the 24-track Betty Boo tape he samples the samples into the Amiga using the Futuresound sampling hardware and AudioMaster II software. Then, with the samples lined up and ready to go, all he has to do is put them together into a song. Which is not as easy as it sounds.

This is done using a PD tracker program of some kind: Richard uses *SoundTracker*, *NoiseTracker* and *StarTrekker*, depending on which is easiest for the particular things he wants to do. From here on in it's nine tenths perspiration and one tenth inspiration getting the song composed. The first of these is a little tricky to get hold of, but the others you can buy from any good PD library. But you don't need to, because we've given you *NoiseTracker* on this month's Coverdisk.

"The biggest problem is the length and the pitch of the samples" says Richard. If you want to make a sample shorter, it usually goes up in pitch. You need all the samples to be in the same key for the song, as well as being the right length. It's a tricky process, but Richard uses the Audiomaster II software to edit the samples until they're all in the key he needs and the right lengths. Once again, you don't need to do this tricky part of the process: because for our Coverdisk demo, Richard has prepared all the samples for you.

The game soundtrack that Richard develops from the Betty Boo song isn't just a slavish imitation of the original record: it is actually a

**NATION 12**

**Featuring Ultravox founder John Foxx and one-time Fall member Simon Richards, Nation 12 have yet to release their first album, but they're well keen on the computer connection and have already contributed three tracks off the album to Renegade games: Into the Wonderful for Gods, Brutal Deluxe in Speedball 2 and an as yet un-named track for the latest Renegade project, The Chaos Engine.**

**BETTY BOO**

**The spacy mistress of rap pop is another Rhythm King artist. She's now off making it big Stateside, but her first hit single 'Doin the Do' has been turned into the soundtrack on Magic Pockets. This bouncy little song fits the fun feel of the game nicely and will no doubt work well.**

remix and intended to be different. Although the song has been carefully chosen to be appropriate for the game – the upbeat Boo for *Pockets*, as opposed to the more sombre and thoughtful Nation 12 track on *Gods* – the Amiga remix has to be tweaked for maximum in-game feel. And there will be several distinctly different versions to play along with various bits of the game. The idea is to make new tunes which are appropriate to the game as a whole and, more specifically, to various bits of the game: the intro music might be quite different from the bit that plays between levels, for instance.

When Richard is happy with each piece, it's ready to be sent to the programmers who will put it in the game. Richard saves it as a module, but when the programmers get it they have to take all the samples out of the module and effectively rewrite the tune again, with their player system calling the right bits at the right time. This stage involves much writing of copious notes and drawing of rather bizarre diagrams, as well as constant contact between the games guys and the musician. And then, with luck and skill, it's all ready!

It's a bit mad if you think about it. Betty Boo makes a song up in the studio from lots of different samples, Richard gets it broken back down into samples and then samples the studio samples onto the Amiga, then makes up the samples into a song again. Then he saves the song out as a module and the programmers just break it back down into samples...

**BUBBLE BOBBLE!**

Chewing gum may irritate some, but it's a life-saver for the Kid. When he finds the gum machine he must stand behind it and pull down on the joystick. This causes a bubble to be blown.

Now the kid floats upwards, his direction can be controlled using the joystick. NB There are a large number of aerial nasties here, and the Kid can't fire, so dodge the batters!

**ZOO'S THAT?**

**FROGGERS** – These stripey swines are quite tough and use their exceptionally long tongues to kill.

**SLIMERS** – Little lumps of green stuff, they're real wimps. Two hits with a small twister is enough.

**BATTERS** – Tough flying beasts that make using the bubble gum bonus very dodgy indeed. Beware the batter beasts, my son!

**ROCKERS** – These are smart and will follow fleeing kids. They throw rocks and have a fair range.

**HIDERS** – These guys are invulnerable when they hide in their shells. If you stand next to one, though, it just cowers. Watch it peek out!



One thing to bear in mind when attacking is that just like the Bitmap Kid, monsters are temporarily invulnerable after a hit. The stars show when these creatures, like yourself, are impervious to attack.

**MOUNTAIN BIKING, OK!**

When you find the bike what do you do? Ride it of course, as fast as possible to the exit. To climb on board just stand behind it and pull down on the joystick. Then hit the fire-button repeatedly to get peddling. Don't worry about beasts as the bike kills them. Once the kid goes into wheelie mode you can stop hitting the fire-button.

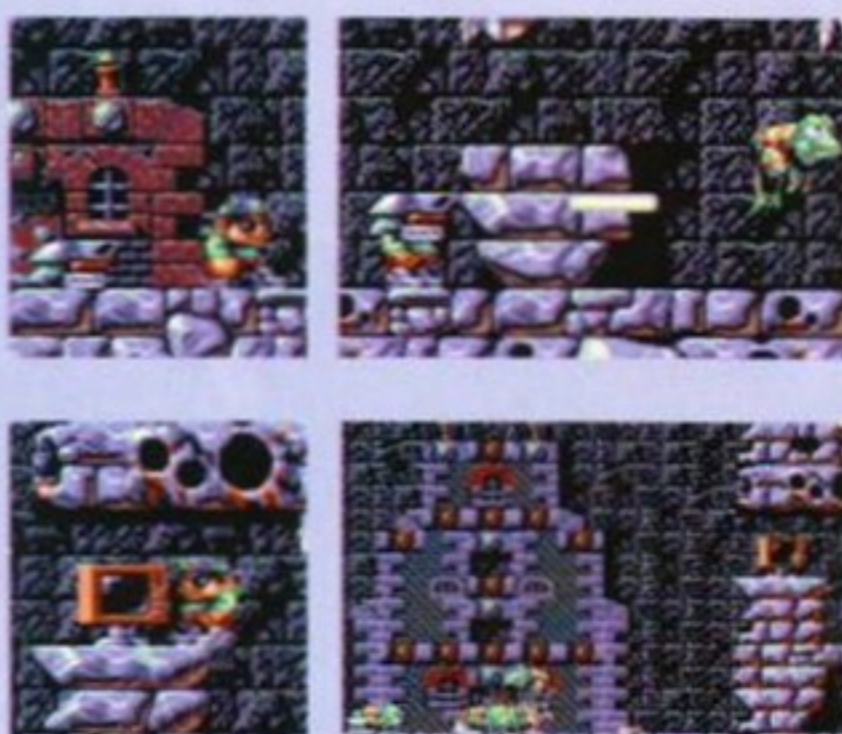

**IF YOU WANT TO GET AHEAD...**  
...Get a hat! This is the laser helmet, and once you've put it on – by pulling down – pressing fire launches laser beams. It shoots through walls and lasts until you take it off (pull down).

**WOT'S ON THE BOX?**  
Pulling down on the joystick to use the TV scans the surrounding area and shows you where the beasts and routes are. To get back to the game, press fire or pull down. All items found lying

around used by pulling down on the joystick. Some, like the bag of nails, work repeatedly: others are 'one shot' only.

**SWEET LITTLE THING**

The bonuses are awarded for specific moves, so different tactics yield different rewards. All the bonuses are sweets or treats the Bitmap Kid wants. The more exotic or expensive the better. Working out how to gain certain items is an essential part of a good high score.



**AMIGA IN ROCK STAR SHOCK 1**  
We've recently discovered that the Godfather of Goth, Sisters of Mercy supremo Andrew Eldritch, is an Amiga fan. Apparently he uses it mostly for playing games. Can we get him to do the music for *Terminator 2*?

Still, before you go crazy, the important bit as far as we're concerned is taking the Amiga samples and making them into an Amiga song. That's the bit at which Richard excels, that's the bit which is the core of the game musician's art and that's the bit which you should concentrate on if you'd like to be a game musician yourself. It's also the most enjoyable part of the process! And the best way to learn how to do it is to try it yourself, so we've given you all the stuff that you will need.

On the Coverdisk you'll find a full set of samples put together by Richard along with a copy of the *NoiseTracker* program that you'll need to create a song with them. The samples that Richard has prepared are actually from a soundtrack he created for a custom car video, so watch out for it. Richard's even edited the samples so they're all the right length and put in a backing track to give you the beat: all you have to do is make a song. Turn over the page now and get on with it!

AMIGA FORMAT

34

SEPTEMBER 1991



**AMIGA IN ROCK STAR SHOCK 2**  
Weird Belgian techno-dance band Front 242 do all their design, from album sleeves to T shirts, using an Amiga and *Deluxe Paint*. Recognise that low-res screen display?



The latest project for Richard Joseph, the man behind all the Renegade game music to date, is to create something with an appropriately mediaeval feel for Millennium's game of the Robin Hood movie. Lutes, anyone?

## So how many flippin' Bitmaps are there anyway?

Every time Renegade announces a new Bitmap Brothers production, there's a lot of talk of who's working on it. And every time there seems to be another Bitmap on board. If you're getting a little confused about who does what, you need the *Amiga Format* complete guide to Bitmap spotting...



**RICHARD JOSEPH**  
Music and sound effects for *Gods*, *Magic Pockets*, *The Chaos Engine*.



**PHIL WILCOX**  
Design for *The Chaos Engine*.



**SEAN GRIFFITHS**  
Programming and Design for *Magic Pockets*.



**STEVE TALL**  
Programming and Design for *Gods*.



**STEVE CARGILL**  
Programming for *The Chaos Engine*.



**TOM WATSON**  
Managing Director, Renegade.



**DAN MALONE**  
Graphic Design for *The Chaos Engine*.



**NADJA SIM**  
PA to Mr Watson.



**ERIC MATTHEWS**  
Creative Director, design for *Gods* and *The Chaos Engine*.



**MIKE MONTGOMERY**  
Technical Director.

And the invisible Mark Coleman, Graphic Design for *Gods* and *Magic Pockets*, and Steve Kelly, Programming Director.

## A Richard Joseph Coverdiskography

You might not realise it, but master musician Richard Joseph's compositions have featured on many an *Amiga Format* Coverdisk demo game. Here's a list of just some...



**CADAVER (ImageWorks)**  
Coverdisk game, Issue 13  
A strange original composition to accompany the last Bitmap Brothers game before Renegade.



**GODS (Renegade)**  
Coverdisk game, Issue 22  
A weird, atmospheric and surprisingly catchy tune from the song *Into the Wonderful* by Nation 12.



**MEGA-LO-MANIA (ImageWorks)**  
Coverdisk game, Issue 25  
The full soundtrack is an appropriately threatening version of *Jupiter*, from *The Planets* by Gustav Holst.



**MAGIC POCKETS (Renegade)**  
Coverdisk game, Issue 26!  
There's only a tiny snatch when you finish the level, but the full intro will be a remix of Betty Boo's hit.

**MOONSHINE RACERS (Millennium)**  
Coverdisk game, Issue 21  
Appropriately crazed down-home country banjo music, created with banjo samples from the Cajun weirdies who kill the city dudes in the cult film *Deliverance*.

# Wordworth

*a writer's dream*

The graphical nature of Wordworth® makes producing documents faster and easier. The WYSIWYG display shows exactly how your printed document will look, different fonts, styles and sizes, headers and footers, graphics and so on.

Commands are grouped under a series of pull-down menus, accessible either by the mouse or keyboard. Frequently used commands have on-screen icons, including Help, should you need it.

Experience the look and feel of the new and exciting WB2 (even if you use WB1.3).

Digita's® innovative *Human Interface Protocol*™ is incorporated and sets new standards in speed, style and elegance. Each document is a separate multi-tasking window, which means you could for example, print one while editing another.

Graphics have always been the Amiga's strong point. Now it's better than ever. Pictures from Deluxe Paint can be placed in a document, and then sized, scaled and dragged (text automatically reformats around the image).

Wordworth's enhanced fonts will give you the very best printed quality. You can also print special symbols, such as boxes, arrows and so on. Better still, you can mix graphics, Wordworth's enhanced fonts, Amiga fonts, Colorfonts and your printer's own fonts, all on the same page.

Wordworth integrates with most word processors, and so you'll be able to use any documents created with Kindwords, Wordperfect, Prowrite, Prottext, Excellence, and any ASCII or IFF Text document.

As Amiga Computing put it, "the only Amiga word processor to rival Prottext for speed. I would recommend the program to anyone thinking of buying their first word processor or upgrading from Kindwords."

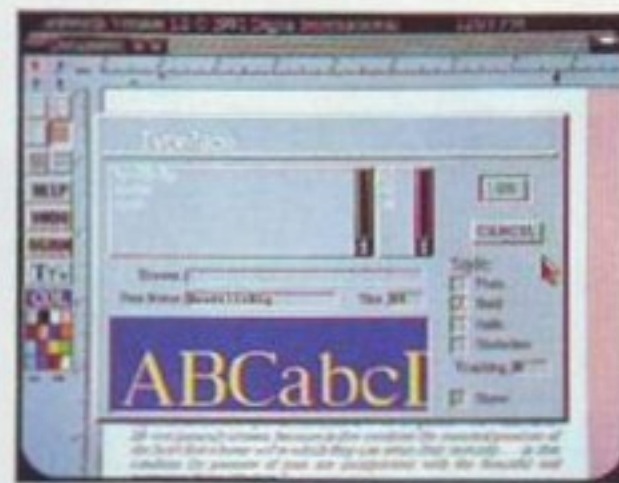
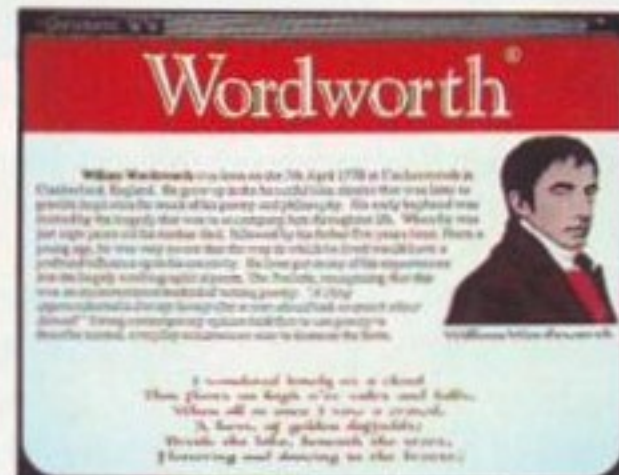

Wordworth is written in the UK by Digita. Which means you'll be using an English Collins spelling checker and thesaurus, and you'll know where to come for professional support.

When Amiga Format said "a new word processor that will give the rest of the world a run for its money" they weren't joking. "Wordworth is the most user-friendly word publisher on the Amiga." Praise indeed.

The only way to really appreciate Wordworth is to use it. Phone 0395 270273 for more information or, write to Digita, FREEPOST, Exmouth EX8 2YZ.

Wordworth costs £129.99, which includes VAT, postage and packing. If you already own a word processor and purchase Wordworth direct from Digita, you can save £30 by returning your original disks with your order.

Wordworth will be your writer's dream. However, if you don't agree with us (and purchased directly from Digita), return it in original condition within 7 days and we will refund your money.

Machine support  
Written specifically for the Amiga  
Fully supports WBV 1.3 and V2.00  
Supports all medium or high resolution modes (mono and colour)  
Requires 1MB of memory

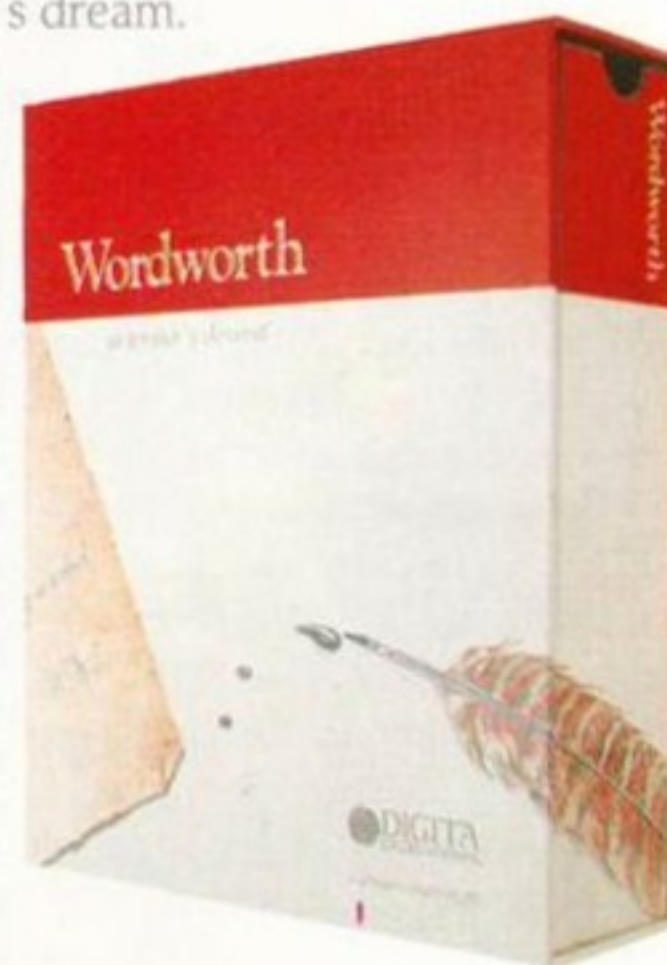
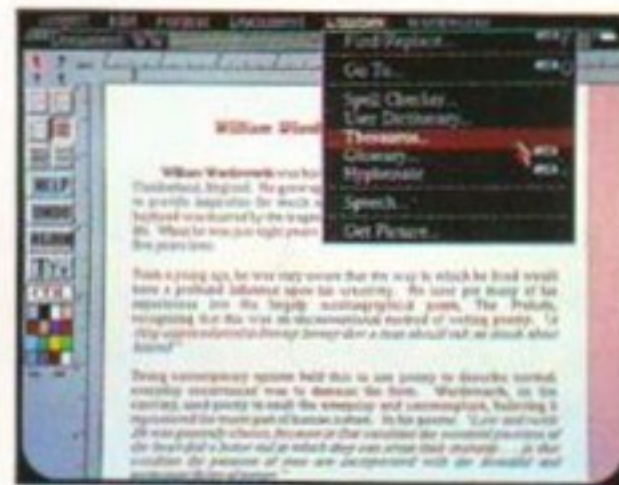

**DIGITA**®  
INTERNATIONAL  
*software that's right*™

Digita International Ltd Black Horse House Exmouth EX8 1JL ENGLAND Tel: 0395 270273 Fax: 0395 268893

- A member of the Digita group -

Digita, the Digita logo, Wordworth and the Wordworth logo are registered trademarks, and *HIP: Human Interface Protocol* and *software that's right* are trademarks of Digita Holdings Ltd. All other trademarks and their owners are acknowledged. Sold subject to standard conditions of sale E & OE

Now that you know the basic idea, have a go yourself! When you've loaded up the NoiseTracker program from the Coverdisk, you're all ready to take the samples that Renegade have provided and make a tune.

**Pat McDonald** shows the way...

# Doing the Do Yourself

AMIGA FORMAT

36

SEPTEMBER 1991

**TO GET STARTED**, just follow through the instructions on these pages. If you have any problems, these little hints might help...

If you find a sample is too low in tone, hit the F2 key. This should raise it up a bit. Similarly, F1 brings the note down in tone.

If the mouse pointer goes purple, then you have accidentally pressed the right button to edit some text (a file name, say). Press the left mouse button or Return to get back to normal.

When mixing the supplied samples, it's easiest to start with adding a Scratch sample. Just play about with it (don't bother recording) until you get a reasonable set of scratches. Then record them. Then try the Pop, which is a tiny bit trickier. The drums come next - there's a Snare and Bassdrum in there.

The hardest part to *NoiseTracker* is understanding the commands. This involves typing a number or letter immediately to the right of the music note. To break to the next pattern, for example, you would have to put a D towards the end of the pattern - see the example commands. Don't forget to adjust the length of the song by one, otherwise you won't hear the two patterns in succession.

Have fun and take your time. Thanks to the PD programmers who have worked on the software, for no financial reward (too many to name here, but you know who you are). Finally, thanks to Richard Joseph and Tom Watson of Renegade software for providing the example on disk - it's from the music set-up as used by the Bitmap Brothers, you know!

## THE THEORY

Rather than just playing one very long sample (which would take up far too much space in memory and on disk), *NoiseTracker* lets you build up music by arranging small samples into patterns. Then you can arrange the patterns into the full song.

When you first load *NoiseTracker*, the four columns of numbers represent the four sound channels of your computer. All the columns are filled with zeroes, because the program starts up blank every time. Every pattern has 64 spaces for notes to be entered.



**GOING TO DISKOPS**  
This is the first screen you'll see once you've loaded *NoiseTracker*. For the moment, just click on the DiskOps button using the left mouse button.

## LOADING THE MODULE

When you click on DiskOps, the top-right part of the screen changes and buttons for the various disk operations appear. Time to load a song! Just click on L Module, then on MixThis (which will appear). Then click on Exit.

**L MODULE:** Load Module. Click on this first! You will see the name Mixthis appear. Click on the name, the module will load.

**S MODULE:** Save Module. Out to floppy disk, naturally.

**D MODULE:** Delete Module. Use with care!

**S SONG:** Save Song. Once you've created a masterpiece, you'll probably want to save it onto floppy disk.

**D SONG:** Delete Song. Wipes a song file from a disk. Use with care!

**L Song:** Load Song. Loads any *NoiseTracker* or *SoundTracker* song into the program, but you won't have any yet.

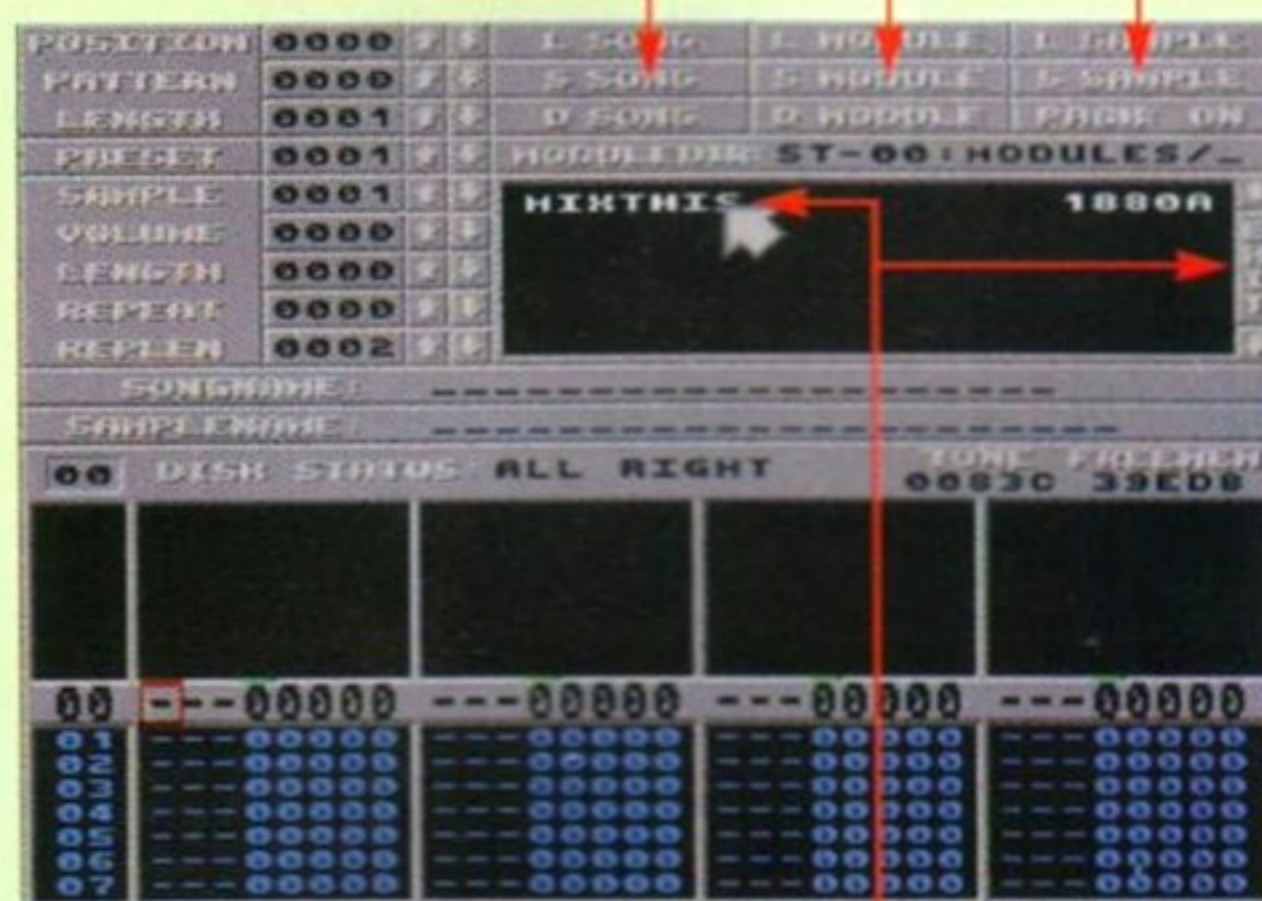

**L SAMPLE:** Load sample. *NoiseTracker* can load both IFF samples and raw binary samples.

**S SAMPLE:** Save sample. Not a lot of point, unless you're taking apart someone else's song to nick the samples. The currently selected sample is saved.

**D SAMPLE:** Delete sample. Again, be careful!

**MIXTHIS:** Name of the module. It will only appear after you have clicked on L Module.

**EXIT:** Once you have loaded the MixThis module, click here to return to *NoiseTracker*.

## IT'S POPULAR!

There are two main strengths to *NoiseTracker* (or *SoundTracker*, or *ProTracker*, or *StarTracker* - there are many variations). The first is that it's easy to learn how to use the program just by playing around with it. Musicians tend to like simple, uncluttered systems that let them jam until they find the song.

Another point is that it's fairly easy for a competent machine code programmer to incorporate *NoiseTracker* modules into programs. This is why the program is used by many professional games software houses - they just hand the program to a musician, wait until some decent music is produced, and then slap it into the game. The same goes tenfold for PD machine code wizards.

## IT'S UNPOPULAR!

*NoiseTracker* gives you very few hints as to how to do things. It's one of those programs you either like or dislike - certainly it's proved its usefulness many times over, but quite frankly it's not everyone's cup of tea. It doesn't like hard drive systems or living on a disk that isn't called ST-00, and it uses hexadecimal numbers for just about everything.

Another very important point is that it only works properly on A500s. It loads and runs on A2000s/A1500s, but the keyboard doesn't work, which renders the program useless. The joys of PD... Still, at least it's cheap and widely available and used, so it does have some things going for it.

## PLAYING WITH SOUND

The main *NoiseTracker* screen changes again after you have exited DiskOps – the Spectrum Analyzer appears. The musical notes on *NoiseTracker* are played a bit like a musical keyboard, but on the Amiga's keys. The keys Z through M play the lower notes (with sharps above and to the right) and Q through P play the higher notes, again with sharps. Play about with these keys – the 'Huh' sample that loads up first you can play it at different tones and speeds.

**UP DOWN ARROWS:** Click on these to change the selections.

**PATTERN:** This is the current pattern for playback and editing.

**POSITION:** *NoiseTracker's* current start playback.

**LENGTH:** Change the length if you create extra patterns.

**PRESET:** The preset sample list requires you to configure *NoiseTracker* using machine code. Don't bother with it.

**SAMPLE:** The current sample you are playing. This should start off as Huh, but there are others to listen to. Click on the up and down buttons to hear them all.

**VOLUME:** Click here to adjust how loud the sample will play (maximum of 40).

**LENGTH:** The length of a sample. Adjusting the length can create some interesting variations.

**REPEAT:** How many times the sample loops.

**REPLEN:** Erm... Your guess is as good as ours!

**SONGNAME:** The name of the track you are working on is displayed here.

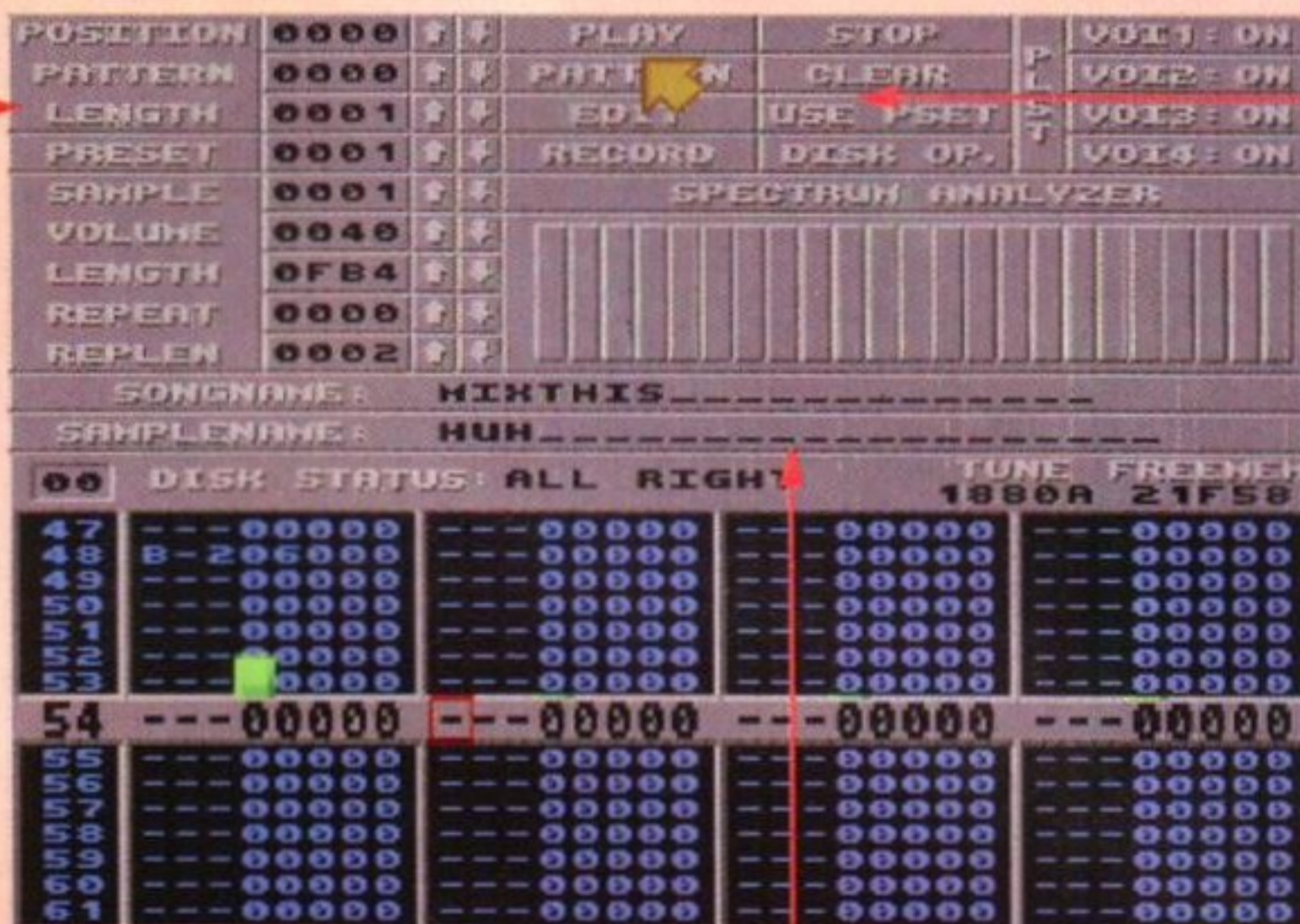

**SAMPLENAME:** Check here for the name of the sample you are currently using.

**00:** This is the pattern number. It's handy to know which patterns you are editing.

**DISK STATUS:** If there's a problem with your floppy disk drive, it will be displayed here.

**TUNE:** How much memory does your music take up? Check here!

**FREEMEM:** How much memory have you got to play with? This is where to look.

**VO11, 2, 3, 4:** By clicking on these buttons you can stop any sound from being played on any sound channel.

**PLST:** Preset List. Don't worry about it!

**PLAY:** Listen to the whole song by clicking here. Note that the Pattern, Position and Length govern what is played. Select it now – the backing track by Richard Joseph will play.

**STOP:** Stop playing the music by clicking here.

**PATTERN:** Play the current pattern only.

**CLEAR:** Wipe *NoiseTracker* clean by clicking this button. It's the way to start again if you've messed the whole song up.

**EDIT:** Don't play around with this yet! It's used to manually set notes in a pattern. You have to do this sometimes, just to tidy it up.

**USE PSET:** Not supported. Leave it.

**RECORD:** Rather than editing your music by hand, you can play the keyboard live straight into a track.

**DISK OPS:** You already know what this one does, because you've used it!

**SPECTRUM ANALYZER:** Gimmicky but cute, this will show you graphically the tone of the sample you're playing.

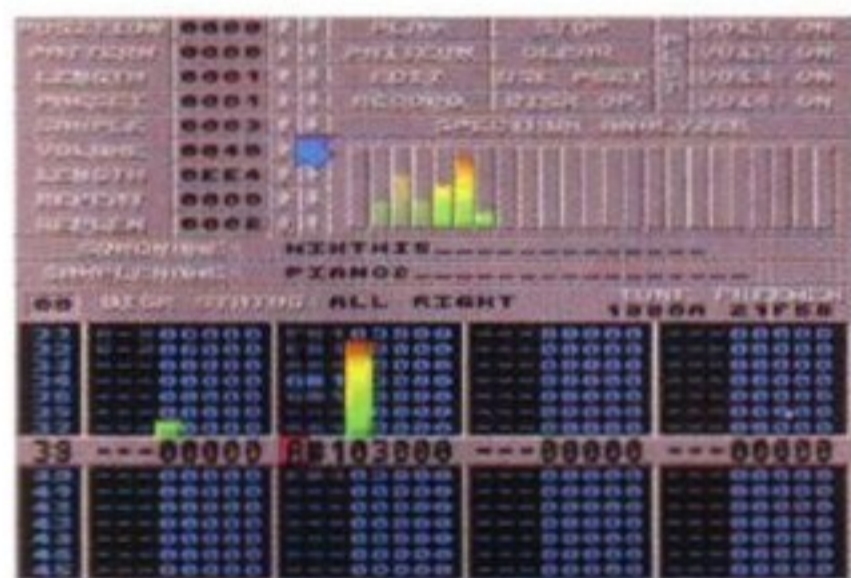

**ADDING TRACKS:** Adding a track to the existing backing is very easy. Just click on Record, move the cursor with the cursor keys to the second column of numbers, and play the keyboard over the top. Don't worry if you don't get it quite right – that's what the edit button is for. Click on Stop when you've finished.

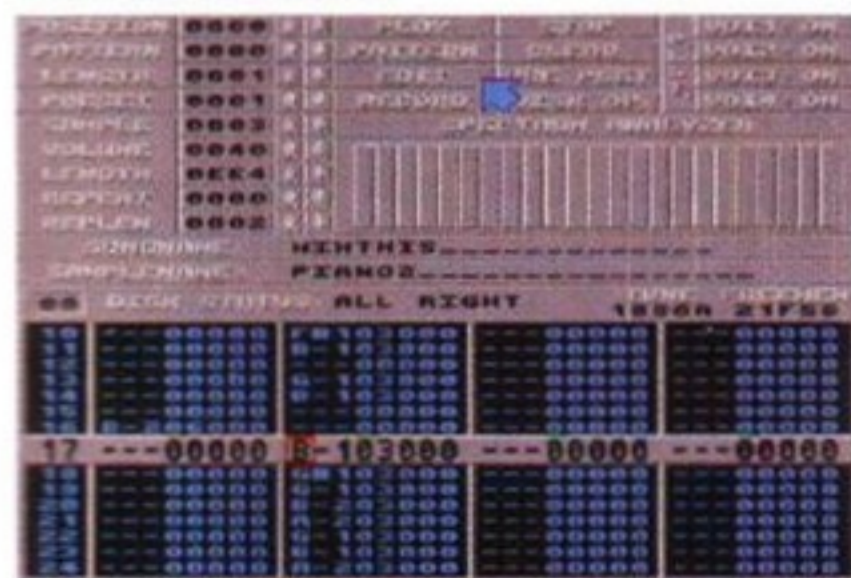

Click on the Edit button (or press the Space bar) to fine-tune your creations. This allows you to move up and down the column of numbers with the cursor keys, and across them as well. Use the Delete (Del) key to blank unwanted samples, and play the note to enter it. Simple. Press the left mouse button (or the Space bar again) to exit Edit mode – when you're editing, the mouse pointer goes blue.

## COMMANDS

You may notice that there are some numbers after the sample note. These trigger *NoiseTracker* to do something to the note, apart from playing it neat. To alter them, use the cursor keys while the program is in edit mode (the cursor is blue).

To deactivate the command, you have to enter a zero (0) into the command space. Here's a list of the available commands. Note that all the numbers are hexadecimal: that is, you can specify numbers from 10 to 15 by using the letters A to F:

**0 ARPEGGIO** – 0 + second halfnote-add + third halfnote-add

This command will produce a one-channel chord.

C-3 00037 produces a minor-chord

C-3 00047 produces a major-chord

**1 PORTAMENTO UP** – 1 + portamentospeed

This slides the pitch up.

C-3 00103 1 is the command, 3 is the speed.

**2 PORTAMENTO DOWN** – 2 + portamentospeed

This command slides the pitch down.

C-3 00203 2 is the command, 3 is the speed.

**3 TONE-PORTAMENTO** – destination-note + 3 + speed

This will automatically slide from the old note to the new. To keep on sliding, just select the command 3.

C-3 00305 C-3 is the note to slide to, 3 the command and 5 the speed.

**4 VIBRATO** – 4 + vibratospeed + vibratosize

Make the sound oscillate (bounce up and down)

C-3 00481 4 is the command, 8 is the speed of the vibrato and 1 is the size of the vibrato.

**D PATTERN-BREAK** – D + nothing

This will end your pattern and go on with the next one.

C-3 00D00 D is the command, all others are a waste.

**A VOLUME-SLIDE** – A + upsidespeed + downsidespeed

Adjust volume up or down gradually

C-3 00A05 5 is the speed to turn down the volume

C-3 00A40 4 is the speed to slide it up.

**B POSITION-JUMP** – B + song-position to continue at Jump to a different position in the song. Mostly used for restarting the song.

C-3 00B01 1 is the place to restart the song at. This command will also perform a pattern-break.

**C SET VOLUME** – C + new volume

Sets the current volume to your own selected. The highest volume is 40. All volumes are represented in hexadecimal.

C-3 00C10 C is the command, 10 is the volume.

**E SET FILTER** – E + filter-status

This command turns the sound-filter on and off. It's not fitted to early machines, so avoid using it if possible.

C-3 00E01 disconnects filter (turns LED off)

C-3 00E00 connects filter (turns LED on)

**F SET SPEED** – F + speed

This will change the speed of your tune. (how fast your patterns will roll). Speeds from 01 – 1F are allowed.

C-3 00F07 sets speed to 7

NEW!  
CARTOON CLASSICS PACK

# SORDON HARWOOD

**'FLIGHT OF THE INTRUDER' 1Mb Packs now available!**  
(FANTASTIC NEW FLIGHT SIMULATOR + + + + COMMODORES NEW CARTOON CLASSICS!!!)



NEW!  
1Mb. Amiga

## POWERPLAY

### INTRUDER PACK 1

THAT'S RIGHT HARWOODS HAVE PUT TOGETHER THE ULTIMATE  
CARTOON CLASSICS PACKS YET AGAIN, STARTING WITH 'FLIGHT OF THE INTRUDER'  
PACK 1 AND INCLUDING 14 GREAT GAMES!

Just look at what  
you get NOW...

- ★ AMIGA A500 COMPUTER WITH 0.5Mb. UPGRADE TO A FULL 1Mb.
- ★ FLIGHT OF THE INTRUDER ★ PLUS 10 MORE GREAT GAMES...
- ★ THE SIMPSONS ★ Datastorm ★ Drivin Force
- ★ CAPTAIN PLANET ★ Dungeon Quest ★ Pipemania
- ★ LEMMINGS ★ E-Motion ★ Rock 'N' Roll
- ★ MICROSWITCHED JOYSTICK ★ Grand Monster Slam ★ Skweek
- ★ TAILORED DUST COVER ★ RVF Honda ★ Tower of Babel
- ★ MOUSE MAT ★ AND...DELUXE PAINT III WITH ANIMATION!!!

NEW CARTOON  
CLASSICS PACK

...The pack for any serious  
Games Enthusiast!

INTRUDER PACK 1  
PRICED AT AN  
INCREDIBLE...

**£399** \*

# INTRUDER

ALL OUR AMIGAS  
ARE UK SPEC AND  
INCLUDE THE  
FOLLOWING...

- ☐ 1Mb. Disk Drive
- ☐ TV Modulator
- ☐ 4096 Colours
- ☐ Multi Tasking
- ☐ Speech Synthesis
- ☐ Amiga Basic
- ☐ Programming
- ☐ Language
- ☐ 4 Channel Digital
- ☐ Stereo Sound
- ☐ Amiga Mouse
- ☐ 3 Operation
- ☐ Manuals
- ☐ Workbench
- ☐ 1.3 Disks
- ☐ Tutorial Disk
- ☐ ALL Cables
- ☐ Simple 'Notepad'
- ☐ Word Processor

PLUS...  
All OUR Amigas are  
backed by Harwoods  
Great Service (please  
see full details in our  
'Ordering Made Easy'  
panel on Page 3)



## MONITORS

THE SUPERB PHILIPS  
CM 8833/II STEREO  
COLOUR MONITOR  
Stereo High Resolution Colour Monitor

The Philips CM 8833 Mk II is the successor to the  
ever popular CM 8833. This versatile multipurpose 14-inch  
monitor offers excellent colour graphics performance with a wide  
range of home and personal computers.

The CM8833/II can also be used as a TV Monitor when connected to either  
a VCR, Colour or Mono Video Camera or TV tuner (available separately).

- Please ask for further details.
- ☐ RGB/AI, TTL, Comp. Video & stereo audio inputs
  - ☐ Can also be used as a TV with VCR or Tuner
  - ☐ Features retractable foot ☐ Twin Speakers
  - ☐ FREE lead for YOUR computer ☐ Earphone Jack Socket
  - ☐ FREE 12 Month on site service warranty.

A MOST VERSATILE STEREO COLOUR  
MONITOR AVAILABLE FOR ONLY...

**£249.<sup>95</sup>** ☐

CBM 1084S STEREO COLOUR MONITOR  
Commodore's Own Stereo High Resolution Colour Monitor

- ☐ RGB/AI/TTL, Comp. Video/Audio Inputs
- ☐ Can be used as TV with VCR or tuner
- ☐ Twin Speakers for stereo output
- ☐ Supplied with cables for A500, CGA PC, C16-64-128

**£269.<sup>95</sup>** ☐

Amiga 1Mb.

# POWERPLAY

## INTRUDER PACK 2

**HARWOOD'S BRILLIANT AMIGA 1Mb FLIGHT OF THE INTRUDER PACK 2**

The fantastic Amiga and ALL THE EXTRA'S detailed in Harwoods Intruder Pack 1 above, AND then you also get...



### THE SUPERB PHILIPS CM8833/II STEREO COLOUR MONITOR

Twin Stereo Speakers, Green Screen Switch, Lead to Amiga, Free Tailored Dust Cover and 12 Months on-site warranty (See monitor panel for details)



**A SPECIAL PACK FROM HARWOOD'S TO LET YOU SEE THOSE GAMES WITH SUPERB CLARITY AND IN FANTASTIC STEREO FOR ONLY...**

**£629.95**



# INTRUDER

Amiga 1Mb.

# POWERPLAY

## INTRUDER PACK 3

**HARWOOD'S BRILLIANT AMIGA 1Mb FLIGHT OF THE INTRUDER PACK 3**

The fantastic Amiga and ALL THE EXTRA'S detailed in HARWOODS Intruder Pack 1 above, and then you also get...

### THE SUPERB PHILIPS CM 8833/II STEREO COLOUR MONITOR

With FREE Dust Cover and Cable to your Amiga and including a 12 Months on-site warranty (See monitor panel for details)



### THE BRILLIANT STAR LC200 COLOUR PRINTER...

185/40 cps, Full Colour 9 Pin NLO Dot Matrix Printer with FREE Dust Cover and cable to your Amiga (See printers on page 3 for further details) (Or choose an alternative from our range & adjust by the difference in price from the listed LC 200 price on page 3)



**NOW AVAILABLE WITH THE CITIZEN SWIFT 9 COLOUR PRINTER AT NO EXTRA COST!!!**  
(IN PLACE OF STARS LC 200 COLOUR)

**A SPECIAL MONITOR AND PRINTER PACKAGE FROM HARWOODS TO SET YOU UP COMPLETELY AND ALL AT A PRICE YOU'LL FIND HARD TO BEAT!**

**£834.95**



# INTRUDER

Amiga 1Mb.

# POWERtech

## INTRUDER EDUCATION PACK 4

**A MORE SERIOUS PACKAGE ASSEMBLED BY HARWOOD'S INCLUDING 'CLASS OF THE 90'S' FIRST STEPS (ie) ALL OF THE FOLLOWING...**

- ★ AMIGA A500 COMPUTER WITH 1Mb. FLIGHT OF THE INTRUDER
- ★ PRO-WRITE 2.5 (Wordprocessor)
- ★ INFOFILE (Database)
- ★ MUSIC MOUSE (Instrument Program)
- ★ LET'S SPEEL AT HOME
- ★ AMIGA LOGO with TALKING TURTLE
- ★ BBC BASIC EMULATOR
- ★ DELUXE PRINT II and DELUXE PAINT II, FULLY MICROSWITCHED JOYSTICK
- ★ TEN BLANK COMMODORE 3.5" DISKETTES
- ★ MOUSE MAT, PLUS... TEN GREAT GAMES

DATAstorm, Dungeon Quest, E-Motion, Grand Monster Slam, RIVF Honda, Drive Force, Pogemania, Rock 'N' Roll, Shweek, Towers of Babel.

**ALSO INCLUDED WITH PACK 4 TO HELP YOU PROGRESS...**

- ★ FREE! A STEP-BY-STEP VIDEO TAPE! How to set up and get the most from your new... Amiga A500 and software pack
- ★ FREE! NATIONAL CURRICULUM RESOURCE FILE An explanatory file about applying First Steps software within the National Curriculum
- ★ FREE! FOR PARENTS Deducing the basic elements for parents with Primary and Secondary School children

**HARWOOD SPECIAL INTRUDER PACK 4 AT A SPECIAL PRICE**

**£499.95**



**NOW AVAILABLE WITH THE CITIZEN SWIFT 9 COLOUR PRINTER AT NO EXTRA COST!!!**  
(IN PLACE OF STARS LC 200 COLOUR)

**BUILD YOUR OWN PACK...**  
PACK 5-As above with CM8833 £729  
PACK 6-As Pack 5 + LC200 Col. Printer £929

**WE ALSO HAVE OTHER AMIGA EDUCATION PACKS... PHONE NOW FOR FULL DETAILS!**

Amiga 1Mb.

# POWERPRO

## INTRUDER BUSINESS PACK 7

**INTRUDER PACK 7 COMES FROM HARWOODS AND INCLUDES ALL THE FOLLOWING... A PROFESSIONAL PACKAGE PUT TOGETHER FOR THE BUSINESS MINDED AMIGA USER**



AMIGA A500 WITH 1Mb. MEMORY INC. CLOCK (See Standard Features List)

+ SUPERB PHILIPS CM 8833/II STEREO COLOUR MONITOR

+ STAR LC200 9 PIN NLO FULL COLOUR PRINTER (Or choose an alternative from our range, and adjust by the difference in price)

+ A HOST OF BUSINESS SOFTWARE & ACCESSORIES... PEN PAL V1.3 (Word Processor)... 1Mb. SUPERBASE II PERSONAL (Database) SUPERPLAN (Spreadsheet)... 1Mb.

- ★ TUTORIAL DISK
- ★ THE SIMPSONS
- ★ CAPTAIN PLANET
- ★ LEMMINGS
- ★ DELUXE PAINT III
- ★ Now with ANIMATION AND... FLIGHT OF THE INTRUDER
- ★ MICROSWITCHED JOYSTICK
- ★ 10 BLANK 3.5" DISKS
- ★ DISK LIBRARY CASE
- ★ MOUSE MAT
- ★ 3 TAILORED AMIGA DUST COVERS



**WE MEAN BUSINESS AT THE GREAT LOW PRICE OF JUST...**

**£899.95**

**NOW AVAILABLE WITH THE CITIZEN SWIFT 9 COLOUR PRINTER AT NO EXTRA COST!!!**  
(IN PLACE OF STARS LC 200 COLOUR)

## Apple in Alfreton...

From June Gordon Harwood Computers will be supplying the outstanding Apple Macintosh range of complete Hardware and Software Solutions available from just... **£675**

As an Apple Authorised Dealer, systems are available through our showroom only. Please visit us for your personal introduction to this exceptional range of friendly to use yet powerful graphical computers



Gordon Harwood Computers



Authorised Dealer

**REMEMBER AFTER YOU'VE BOUGHT FROM HARWOODS, WE'LL STILL BE HERE...**

**TECHNICAL SUPPORT:** You will be given our Exclusive Technical Support Phone Number to call should you require any help or advice on any aspect of the system you have purchased.

**12 MONTH WARRANTY:** Items proving faulty within 30 days of purchase are replaced with NEW UNITS unless otherwise stated. For the whole of the guarantee period, warranty service will be completely FREE OF CHARGE and a FAST turnaround is GUARANTEED by our OWN ENGINEERS!

**COLLECTION FACILITY:** Computers, monitors or printers requiring warranty service can be collected from your home FREE OF CHARGE during the whole guarantee period (UK Mainland only)



ORDER HOTLINE 0777 836781

Please see page 3 for our easy ordering procedures. Just compare the service we offer!

## Amiga STORAGE

### CUMANA SUPERSLIM 3.5" 2nd DRIVE

- With Long Cable, Disable Switch, Throughport, Access Light. For 500/1000/2000/3000

*New Low Price!!!*  
**£57.95**

### COMMODORE A590 20Mb HARD DISK DRIVE WITH 0.5 Mb. MEMORY

- Commodore's own hard drive for the A500
- Autoboot with Kickstart 1.3
  - Sockets for up to 2Mb RAM expansion
  - DMA access.  External SCSI port
  - Complete with 0.5 Mb. Memory FREE!

**£299.95**

### COMMODORE A590 20Mb HARD DRIVE BUT... UPGRADED TO A FULL 1Mb.

As above but with a total of 1Mb memory!

**£319.95**

### COMMODORE A590 20Mb HARD DRIVE BUT... UPGRADED TO A TOTAL OF 2Mb.

As above but with a 2Mb memory!

**£349.95**

Please note that prices for products containing RAM chips may fluctuate from time to time

## AMIGA SOFTWARE, GRAPHICS, SOUND AND BOOKS

**MUSIC 'X' Latest Vers 1.1 with MIDI-INTERFACE & CABLE**  
Latest Version 1.1 - The ultimate professional midi sequencing package on any computer...BAR NONE!

**£79.95**

### MASTERSOUND

High quality 'Mono' Sampler. Mono samples are better than stereo when sampling instruments for your own music with soundtracker

**£33.95**

### MIDI INTERFACE (5 PORT)

In, Out, Through + 2 Switchable Through/Out inc Cable

**£24.95**

### HARWOODS 'PRO-GEN'

NEW HIGH QUALITY GENLOCK AT THE SORT OF PRICE YOU'D EXPECT ONLY FROM GORDON HARWOOD COMPUTERS!!!

Equivalent specification to Rendales' 8802 and compatible with ALL video titling and graphics/animation software!...Requires 1Mb. min.

*Supplied with FREE titling software!!!*  
**£119.95**

FREE 'SPECTRA COLOR' with every Pro-Gen!  
The only 4096 colour paint AND animation program for the Amiga! From the creators of Photon Paint

## PRINTERS

FREE  
Dust Cover with all  
Dot Matrix Printers

All printers in our range include the following features...

Standard Centronics parallel port unless otherwise stated for direct connection to Amiga, PC's, ST etc. and come with a...  
FREE CONNECTOR LEAD & TAILORED DUST COVER!

All the characters Per Second speeds quoted below are Draft LQ at 10cpi

**CITIZEN 120D+ - Up to 120/25 cps** **£149.95**

- Very reliable low cost printer (please specify interface on order)
- Interchangeable interfaces for Centronics RS 232 or Serial type for IBM 64 etc
- Full 2 Year manufacturers warranty

**STAR LC10 - Up to 120/25 cps** **£159.95**

- Our most popular Mono Dot-Matrix printer and at a super low price
- Multiple font options easily accessible from front panel
- Excellent paper handling facilities
- Simultaneous, continuous and single sheet stationery
- 240 x 240 dpi Graphics

**CITIZEN 124D MONO 24 PIN PRINTER** **£209.95**

- 360 dpi - 24 Pin MONO
- 8K Buffer - Expandable
- 3 Fonts, Superb letter quality
- Push & Pull Tractor feeds
- 2yr Warranty
- Feed for labels & multi-part stationery
- Low running costs

**STAR LC 24-10 - Up to 180/60 cps** **£214.95**

- 24 Pin version of the Star LC Series with Exceptional letter print quality
- 360 x 360 dpi Graphics
- Additional font cartridges available
- 8 resident fonts

**STAR LC2000 GREAT COLOUR PRINTER - 185/40 cps** **£214.95**

- This is the one in our packs!
- 80 Column Dot Matrix
- 240 dpi - 9 Pin COLOUR
- 16K Buffer, 8 Resident Fonts
- Micro paper feed, Max. paper width 11.7"
- Supplied with colour & mono ribbons
- Paper park with auto single sheet loading

### VIDI - The Complete Colour Solution

#### Vidi with RGB Splitter, Frame Grabber and Digitiser

Grabs moving colour video into 16 grey scale frames (up to 16 frames on a 1Mb. Amiga) and digitises from still colour video source in up to 4096 colours in less than 1 second!

Requires home VCR or video camera for Grabbing

Requires Video camera or VCR with perfect pause for Digitising

**COLORPIC...The best colour grabber by far!**

Instant colour frame grabbing from moving video. Capture superb digitised video images in a range of resolutions from standard composite video source eg domestic TV video rec. or camera in a 50th of a second.

**RENDALE 8802 Genlock including Cables** **£399.95**

Home/Semi Professional standard Genlock, allows computer display mixes with composite video signals for titling etc.

**MODE SWITCHBOX FOR RENDALE 8802 PRO GEN** **£184.95**

**PROFESSIONAL PAGE Vers 2.0 - Updated release!** **£34.95**

Requires 1Mb...Total Publishing Power; contains its own fully featured word processor. Prints to any preference supported printer in colour or black and white. Supports postscript and colour separations for high resolution image setters.

**£159.95**



**PEN PAL V.1.3**  
**Pen Pal**  
WORD PROCESSOR/DATABASE  
With Pen Pal you can mix text, 4096 colour graphics & data in ways no other w/p can!  
"It's handling of graphics is unsurpassed; Pen Pal is the only word processor I tested that will automatically wrap text round graphics..."  
Amiga World, July '90  
**£79.95**  
PEN PAL Vers 1.3 WITH 512K  
Amiga RAM Expansion £99.95!

## ORDERING MADE EASY

Before you choose from whom to purchase, please give us a call. We are always more than happy to discuss your requirements, and answer any queries you may have...

**ORDER BY PHONE:** Phone our Order Hotline with your Access, Visa, Mastercard or Lombard/NASCAR Credit Charge Card quoting number & expiry date.

**ORDER BY POST:** Make cheques, bankers building society drafts or postal orders payable to GORDON HARWOOD COMPUTERS. (Personal or business cheques take 7 days to clear from day of receipt whereupon your order will be despatched)

Please send Name, Address, and most importantly if possible, a Daytime Telephone Number along with your order requirements. Please check you are ordering from one of our latest advertisements before posting (phone if you require confirmation). Please remember that for example many September publications appear during August, therefore prices you see may have changed (either up or down).

**FREE POSTAL DELIVERY:** FREE within 14 working days, UK Mainland only.  
**OR COURIER SERVICE:** Add £5 per major item for next working day delivery, UK Mainland most regions.

(Goods normally despatched on day of ordering or payment clearance)

**EXPORT ORDERS:** Most items are available at TAX FREE PRICES to non UK residents when visiting us or for export shipment. Please contact us for ordering information.

**REMEMBER AFTER YOU'VE BOUGHT FROM HARWOODS, WE'LL STILL BE HERE...**

**TECHNICAL SUPPORT:** You will be given our Exclusive Technical Support Phone Number to call should you require any help or advice on any aspect of the system you have purchased.

**12 MONTH WARRANTY:** Items proving faulty within 30 days of purchase are replaced with NEW UNITS unless otherwise stated. For the whole guarantee period, warranty service will be completely FREE OF CHARGE and a FAST turnaround is GUARANTEED by our OWN ENGINEERS!

**COLLECTION FACILITY:** Any computer, monitor or printer requiring warranty service can be collected from your home FREE OF CHARGE during the guarantee period (UK Mainland only)

**FULL TESTING PROCEDURE:** All computers are tested prior to despatch, and all items are supplied with mains plug and leads as required - just connect up and use straight away.

**REMEMBER WE'RE NOT JUST ANOTHER MAIL ORDER COMPANY...**

All listed prices are what YOU PAY, and there are NO HIDDEN EXTRAS. VAT and postage are included, and prices are correct at time of going to press (Pack details may vary from time to time). Offers are subject to availability and to being the latest advertised packs and prices. Our offers are NOT supplied on a trial basis.

**FINANCE FACILITIES** Finance tailored to suit your needs. Written details on request.

Gordon Harwood Computers offer facilities to purchase using our budget account scheme. APR 36.8% (Variable). Available to most adults of eighteen years or over, subject to status. Simply phone or write and we will send you written details along with an application form.

Applications, required in advance, available to full time U.K. mainland residents and overseas British forces personnel. Showroom visitors, please ask for details of our in-store "Instant Account". Written quotations on request.

If you are already the holder of a Lombard Credit Charge Card you can use this to purchase from us (subject to your personal card limit)

**VISIT OUR SPACIOUS SHOWROOM**

Please pay us a visit where our full range of advertised products, at the SAME COMPETITIVE PRICES, AND MORE, is on sale. 'ALL UNDER ONE ROOF', in pleasant surroundings at our purpose fitted showroom (See note below map). There's plenty of FREE parking close by.

**OPENING TIMES: 9.00 til 5.00 Monday to Saturday**



**CITIZEN SWIFT 9PIN COLOUR - Up to 160/40cps**

- New super high speed 9Pin colour printer
- 8K Buffer
- Push and pull tractor built-in
- Feed for labels/multi part stationery

**STAR LC24-200 24 PIN MONO PRINTER - 220/55 cps**

- New Star 24 pin that means business!
- 80 Column Dot Matrix
- 360 dpi - 24 Pin MONO
- 7K Buffer expandable to 39K
- 10 Resident Fonts
- Front Panel Pitch Selection
- Push/pull tractor & rear/bottom feeds
- Reverse paper feed

**STAR LC24-200 NEW COLOUR PRINTER - 220/55 cps**

- Colour version of the new LC24-200 Mono
- 80 Column Dot Matrix
- 360 dpi - 24 Pin COLOUR
- 30K Buffer expandable to 62K
- 10 Resident Fonts
- Front Panel Pitch Selection
- Push/pull tractor & rear/bottom feeds
- Reverse paper feed
- 12 month warranty

**CITIZEN SWIFT 24 PIN COLOUR - Up to 160/50 cps**

- 24 Pin Colour Printer 'EUROPEAN PRINTER OF THE YEAR 1990'
- Push and pull tractor built-in with bottom feed for labels & multi-part stationery
- 360 x 360 dpi Colour Graphics
- 2 Year Citizen warranty

**STAR XB PRINTER RANGE Up to 240/80 cps**

- 24-10 COLOUR, OR 24-15 COLOUR
- Two very fast LQ 24Pin Colour Printers (15" Wide Carriage versions 41 exp. to 201K buffer)
- Exceptional print quality
- 4 x 48Pin super letter quality fonts
- 24 x 24Pin near letter quality fonts
- Huge 27K buffer expandable to 187K
- 360 x 360 dpi Colour Graphics
- 12mths on-site warranty (UK Mainland)

**HEWLETT PACKARD PAINTJET A4**

- Our best quality full colour printer at a realistic price
- Parallel/Centronics or Serial RS232 I/F (specify with order, MAC option available)
- For presentation graphics/DTP, CAD and technical/scientific applications
- A full page of colour graphics in 4 minutes (typical)
- Non impact printing
- Virtually silent, 43dba
- 12 Months on-site warranty (UK Mainland)

**STARSCRIPT - 8ppm POSTSCRIPT LASER**

- Up to the minute Laser Printer for PC, Amiga, ST or MAC
- 300 DPI, 2Mb. Upgradable to 5Mb.
- Emulations inc: HP Series II, Epson
- EX800, IBM Proprietary & Diablo 630

**RIBBONS**

Printer Ribbons	SINGLE	6 PACK
STAR LC10 - LC10 Colour & LC10 Mono Black Ribbon	£4.95	£24.95
STAR LC10 COLOUR Ribbon	£6.90	£34.95
STAR LC24-10 - LC24-200, 7804110	£6.90	£34.95
STAR XB24-10 - LC24-200	£14.95	£74.95
STAR XB24-15 - LC24-200	£7.49	£39.95
CITIZEN 2000/39K/39Pin/16K	£4.95	£26.95
CITIZEN SWIFT 9Pin Colour	£4.95	£26.95
CITIZEN SWIFT 24Pin Colour	£7.95	£40.95
STAR LC200 COLOUR Ribbon	£12.95	£69.95
CITIZEN Super 16K	£12.95	£69.95

- £12.95** AMIGA FOR BEGINNERS - VOL. 1 ABACUS BOOKS. From unpacking your Amiga to creating your own copies, includes first use of basic and extras disk.
- £18.95** AMIGA BASIC INSIDE AND OUT - VOL. 2 ABACUS BOOKS. The definitive step by step guide to programming your Amiga in basic.
- £18.45** AMIGA MACHINE LANGUAGE - VOL. 4 ABACUS BOOKS. Practical guide to learning 68000 assembler language on the Amiga.
- £18.45** AMIGA DOS INSIDE AND OUT - VOL. 8 ABACUS BOOKS. The complete guide to Amiga DOS and the CLI. NEW Edition inc. DOS vers 2.0
- £23.95** AMIGA PROGRAMMERS HANDBOOK II - SYBEX. In depth reference to device I/O programming for the Amiga series of computers.
- £21.95** AMIGA HARDWARE REFERENCE MANUAL - ADDISON WESLEY, written by the technical experts at Commodore Amiga Inc. USA. The people who designed your Amiga. Hardware level machine code prog. at advanced level.

**WE ALWAYS CARRY LARGE STOCKS OF THE FULL RANGE OF ABACUS BOOKS...Phone us for details!**

**EDUCATIONAL SOFTWARE For most age groups!**

- £21.95** PRIMARY MATHS COURSE - Ages 3 to 12, Complete 24 Programme Course.
- £21.95** BETTER MATHS - Ages 12 to 16, Higher level to Linear/Quadratic Equations.
- £21.95** MICRO MATHS - 24 easy to use programs for GCSE ('O' Level) revision or self tuition
- £21.95** MEGA MATHS - A 9 level step by step tuition course. Ideal for mature beginners. 'A' Level studies & Micro Maths users
- £21.95** MICRO FRENCH - GCSE French tuition or revision course. Covers both spoken & written French
- £21.95** MICRO ENGLISH - A complete programme of self-tuition up to GCSE standard
- £22.95** THE THREE BEARS - Ages 5-10, Develops imaginative thought/reading skills
- £17.95** SPELL BOOK - Ages 4 to 6, Developed with the help of a Primary School Head Teacher to aid spelling skills.
- £18.95** PLAY AND READ - Ages 4 to 9, The complete reading tutor. Part 2 teaches spelling to the beginner at reading.

**ACCESSORIES**

- £2.99** 3.5" DISK HEAD CLEANER - Essential maintenance for your disk drive. Keep clean and trouble free.
- Only £9.95** **Only £7.95** **Only £72.50** **Only £32.95** BLANK DISKS with labels - 10 Genuine Commodore 3.5" branded - 10 Unbranded with library case 3.5" certified - 200 Unbranded 3.5" certified
- Only £32.95** HARWOODS PRO RAM PACK - 512K Memory Expansion for the Amiga...simply plugs in! 16 Chip, same configuration as A501 for full compatibility with latest 8327A Amiga 1Mb. Blitter. Enable/Disable Switch and Real Time Battery Backed Clock.

**HARWOODS SUPER PRICE DEALS!**

- NAKSHA MICROSWITCHED MOUSE Amiga/ST/Amstrad PC **Only £24.95**
- GOLDEN IMAGE OPTICAL MOUSE For the Amiga **Only £32.95**

Shown above is just a small selection from our vast range of serious Software, Books and Accessories...please phone us with YOUR requirements!

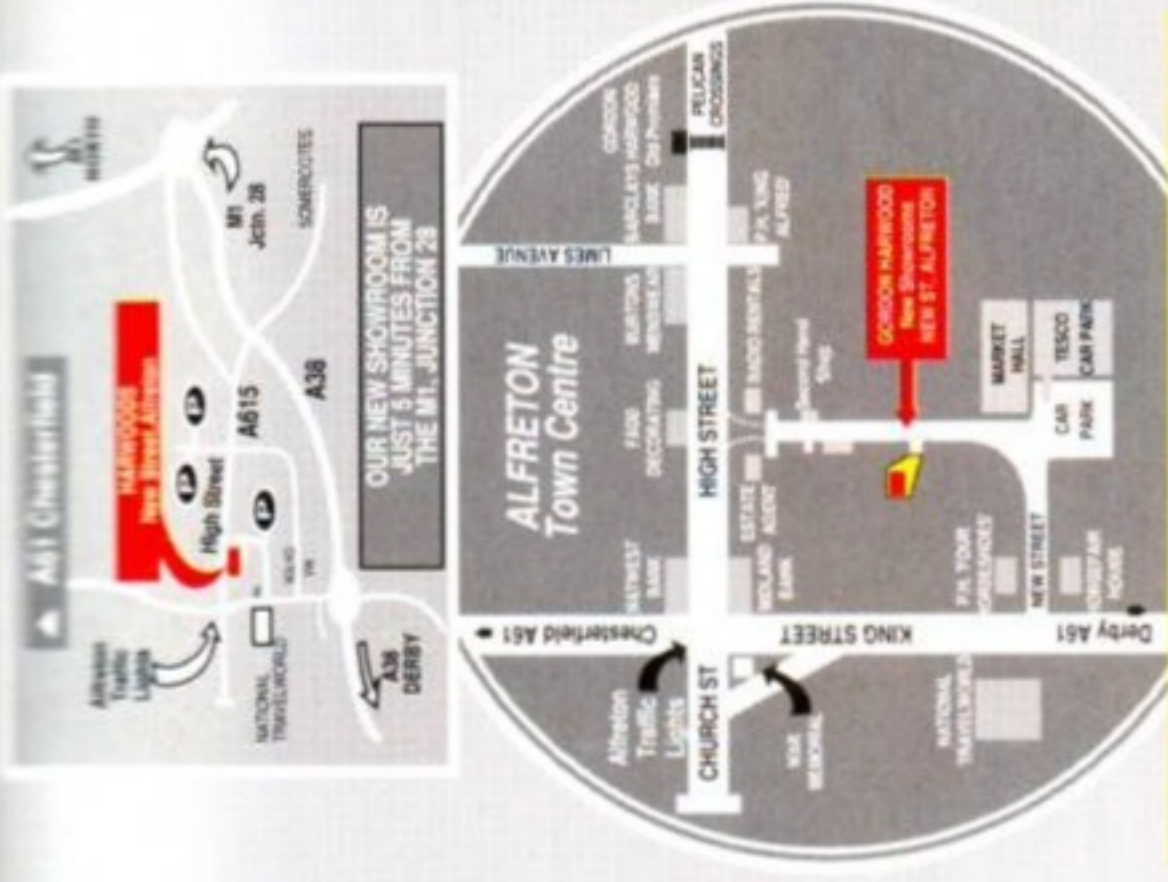

We have several specialised systems on permanent display. However, should you require a 'special' specific product demonstration we will be happy to oblige. Just phone us in advance to make the necessary arrangements.

**GORDON HARWOOD HARWOOD Computers**

ORDER HOTLINE **0773 836781**



GORDON HARWOOD COMPUTERS  
DEPARTMENT AMF/D2, NEW STREET  
ALFRETON, DERBYSHIRE, DE5 7BP  
TEL:0773 836781 FAX:0773 831040

# More Speed. More Memory.



Greater capacity - Greater capabilities.

The protar A 500 HD Series -  
The ultimate Hard Disk Drive.  
Your Amiga will have capabilities  
beyond your wildest dreams.

protar A 500 HD.  
Capacity 20 MB - 160 MB.  
On-board-RAM Option up to 8 MB.  
SCSI-Interface.  
1 year replacement warranty.  
2 years for Hard Disks with Cache.

Flexible capacity for professionals.  
Made in Germany.

Request for further information at  
protar Ltd. • Park House • Greenhill Crescent  
Watford Business Park • Watford Herts WD1 8QU  
Tel. 092 354 133/24 23 07 • Fax 092 321 20 46



# Coming

Looking for the shape of gameplay to come, **Trenton Webb** drives a Ferrari, beats up the odd ninja and even goes in for a bit of fondling.

# Attractions



## Double Dragon 3 The Rosetta Stone

Publisher **Storm** Release **To Be Announced**

It was an excellent arcade machine, but the game has a tarnished reputation on the Amiga after a couple of poor conversions. This should change for the better with the third conversion in the series: the graphics are sharper and so is the gameplay. Power-up extra moves can be bought to help slap down more troublesome foes, there's a puzzle element and a choice of characters to play when you use a 'credit'. The Amiga needs a new beat-em-up champ, and this could be it.

## Outrun Europa

Publisher  
**US Gold**  
Release  
**Late September**

The famous *Out Run* Ferrari gets a bit of rest this time around: the faithful red speedster is just one of the ways you avoid a continental criminal conspiracy who are out to capture you. As well as the Ferrari F40 or a Porsche 911, you get the chance to race a high-powered jet ski over



the English Channel, ride a Yamaha Grand Prix bike through France and take a turbo-powered boat to cross the Med. A strong mix of race ideas, *Outrun Europa* should have a real edge over one-vehicle racers.

## Short stuff



Oh no! It's a crushingly duff movie! And it's coming this way!

Normally software houses fight tooth and nail to get the latest, newest and most costly movies – but Gremlin have to be different. They've just signed the licence to a movie that's universally agreed to be the worst ever made, *Plan 9 from Outer Space*. Fortunately it has far more going for it as a game than it did as a film, because the programming team in charge of the conversion is the excellent **Pixel Productions** (who used to work with **Cinemaware**). To them falls the task of 'shooting' and squeezing over 50 digitised scenes from the movie into the game. Horrendous alien invaders should be landing early next year.

**Electronic Zoo's** controversial *Geisha* will be sold in a brown paper wrapper marked "Adults Only". Seriously! It's the plot that makes it a bit dodgy: you are trying to save your girlfriend Eva who has been kidnapped and "during your efforts to save Eva you will take part in a number of frenzied erotic episodes... such as seduce, caress and excite". And these are the more polite ones! *Geisha's* gameplay is clean enough, though: a series of puzzles and tests of mental agility. No naughties there!

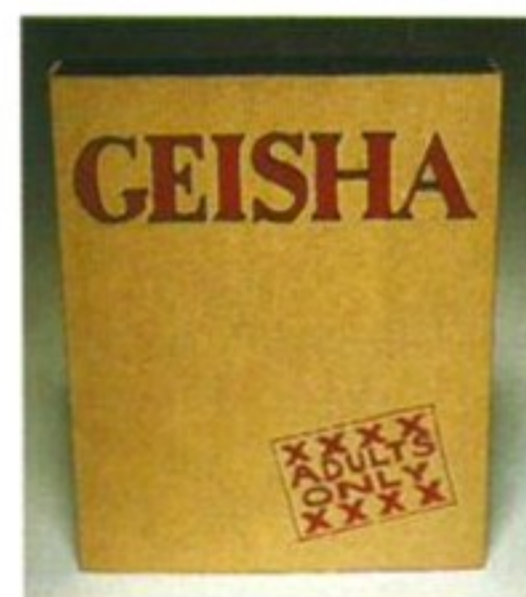

For your eyes only, if you're over 18 with dodgy morals.

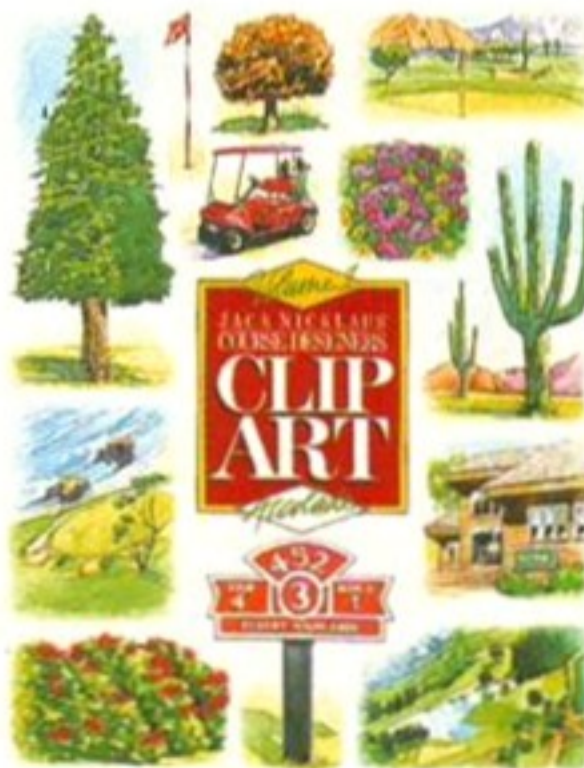

Oooh! What a lovely cactus! That would look nice at the 14th tee.

Supplementary game disks are all the rage again. *Hero Quest Disk 1* goes out this month, as does a rather bizarre golfing extra. Filling out the substantial *Jack Nicklaus* collection comes *Clip Art*, which supports *Jack's Course Design*, allowing you to add extra cacti and ball-washers to the course of your dreams.

Continued overleaf

Like father, like nephew. The whole Godfather saga will be played out by Delphine in US Gold's graphic adventure epic.



The cynics who reckoned that US Gold's *Godfather* licence couldn't possibly make a good game may yet be proved wrong. Delphine, the graphic adventure specialists behind *Cruise for a Corpse* (see the review on Page 64), are to be in charge, giving it a great chance of making the grade.

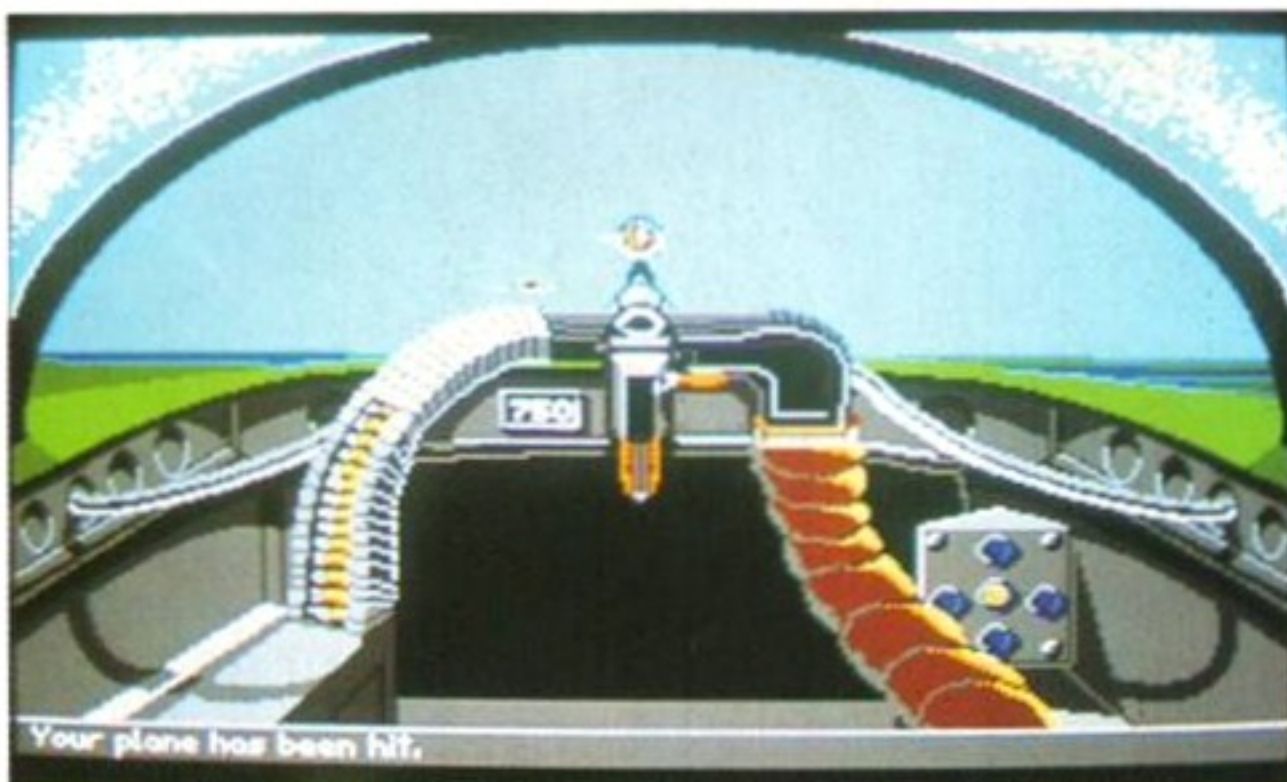

Their Finest Missions - never in the field of computer flying has a game written by so few enthralled so many for so long.

Another additional disk on the way will please fans of the hugely good *Their Finest Hour* from Lucasfilm. Entitled *Their Finest Missions*, it contains 23 new, and incredibly tough, jaunts into the wild blue yonder - including a delightfully named 'Suicide' mission for the real pros. If you're still having trouble getting your Spit back to base, though, don't worry, a proficient pilot for each plane is also provided.

Italian software house Idea has been showing out with a new concept puzzler *Clik Clak*. It's sort of a *Crystal Maze* meets *Pipe Mania*, where you have to try to put together the working parts to make a clock, while working against a tricky time limit. There's a curious plot twist as well - you're building the clocks on famous monuments! This one is strange enough to work as a test of lateral thinking and mouse speed.



Orange clockworks - only less violent!

## Previews update

- Alcatraz** - Infogrames: two months to go, with good behaviour!
- Megaphoenix** - Dynamics: Almost ready to fly.
- Arachnophobia** - Disney/Empire: Still spinning the code.
- Dragon Fighter** - Idea: The first bout has now been rescheduled so expect it to come out of its corner fighting in September.
- Zone Warrior** - Electronic Arts: Has time-warped to late 1991.
- Mad TV** - Rainbow Arts: To be broadcast shortly.

## Big Run

Publisher Storm  
Release December/January



The ferocity of the Paris Dakar Rally has already hit the arcades with Jaleco's *Big Run* and soon Amiga rally drivers will be piling round this car-destroying course too. It'll be a toughie to convert, but if Storm can do it there's some cracking winter racing ahead. Keep death off the roads, drive in the desert!

## Final Blow

Publisher Storm  
Release September



Taito's pugilistic arcade game could be a real contender on the Amiga. Usually arcade features get lost in the conversion to computer, but Storm are actually adding two new opponents to this gentlemen's beat-em-up. Ten fighters are ready to punch you out with a gamut of boxing blows - you just have to stay standing until you find their weak spots!

## Robin Hood

Publisher Millennium  
Release October

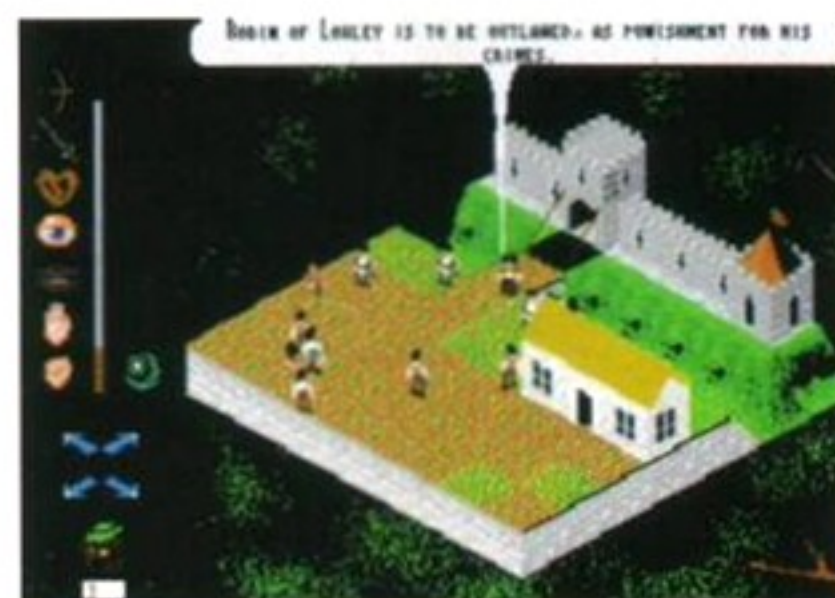

Fortune favours the brave, and fate has smiled on *Robin Hood* with the coincidental release of two major movies. Millennium claim the real-time adventure system *Robin Hood* uses has been seven years in the making! All the characters have histories and a purpose; so players can roam a totally free environment picking up clues, at the same time as robbing the poor to give to the rich - eh?

## Thunderjaws

Publisher Domark  
Release Late Summer 1991



This is a mix of arcade blasting styles, taking the best ideas from the *Rolling Thunder* genre of horizontally-scrolling, balcony-leaping, enemy-shooting two-player action plus a shoot-em-up style swimming section where divers go up against cyber sharks and worse. Authentic arcade graphics are promised along with a custom theme to add atmosphere.

## Cardiaxx

Publisher Electronic Zoo  
Release Autumn 1991



At last there is a game that will bring *Defender*-style action into the 1990s, using textured metallic graphics and masses of samples. Instead of piling through a one-way system shooting all and sundry, you patrol an area - shooting all and sundry! A cyber feel and Arnie-style speech add extra threat.

## Sarakon

Publisher Virgin  
Release September



This puzzler is a race against time to clear a board by identifying matching pairs of tiles and the route between them. The gameplay gets more complex as you progress, with the introduction of multiple layers of tiles on the same board and a time limit. Simplicity is the basis of any puzzle game and *Sarakon* scores there, the only thing that remains to be seen is how Virgin twist this game on the later levels; and that will decide its fate.

Now available for Commodore Amiga

# SILENT SERVICE II™

One already hit.  
Number two is even more explosive.



ACTUAL SCREEN SHOWN.

The original Silent Service was Simulation of the Year around the world in 1986. Now it's back, making World War II submarine combat more exciting than ever.



- outstanding graphics—VGA, EGA, Tandy 16-color
- realistic sounds and original music • new re-play feature
- more game play options • new missions and scenarios

Don't Miss It! **MICROPROSE™**  
SIMULATION • SOFTWARE

Unit 1, Hampton Road Industrial Estate,  
Tetbury, Glos, GL8 8LD Tel (0666) 504326

U.S.N. BUSHIPS  
SUBMARINE PERISCOPE  
DESIGN DESIG. \_\_\_\_\_  
REGISTRY NO. \_\_\_\_\_  
STOCK NO. \_\_\_\_\_  
MAGNIFICATION \_\_\_\_\_ H.P. \_\_\_\_\_ L.P. \_\_\_\_\_  
FIELD OF VIEW \_\_\_\_\_

A *Rainbow Islands* beater? Can Storm's cute coin-op really take the top spot?

“So cute it'll make you ill” boasts the press release – which may not sound like a compliment, but it is! What's more it stands every chance of being true! Ever since they finished *SWIV*, the Storm crew have been undergoing lessons in being cute, as they try to convert the Jaleco coin-op classic on to the Amiga.

The tale is of everyday fairy folk who are on a mission to save their mom – who went and got herself kidnapped by a passing eagle. The trail leads them to a tower filled with platforms, flowers, ladders and monsters. The kids must dart up ladders, to reach the platforms, to collect the flowers and avoid the beasts.

As with all cute heroes Tam and Rit have a special power. In *Rodders* it is the ability to create a temporary ladder to any platform

Tam, half of the hero team, is under attack from a potato monster. This will call for some swift footwork and nifty use of the magic rod. If she can catch the beast and bash its head on the floor then it will turn into a bonus – which will help wipe its fiendish friends.

Oh no it's the pathetic sharks! Their tears are deadly, so Tam had better take care when collecting the flowers – these flowers are the source of bonus points and are worth nabbing.

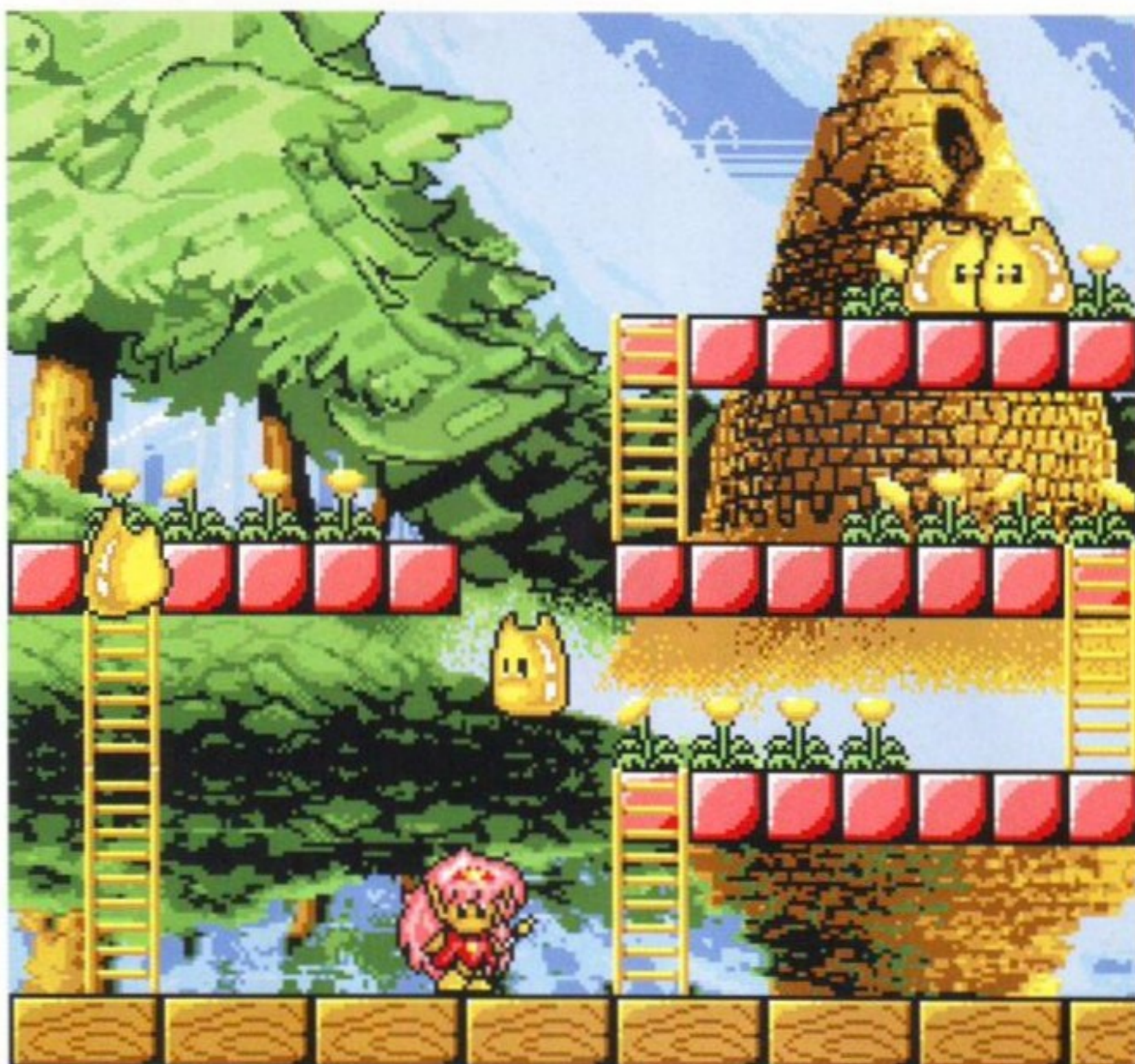

# Rodland

Publisher **Storm** Release **September 1991**

**Rodland** is an instant visual hit, especially when the monsters animate. Each has its own characteristics, but these aren't just cosmetic, they show when and how the creatures will attack Tam and Rit.



## Tears of a clown

Supporting the gameplay is a strong – tongue-in-cheek – sense of fun. The creatures look humorous, but have a psychotic glint in their eyes. Starfish wibble, wobble and giggle but throw a mean boomerang. Sharks break down into bouts of tears, but these are tears of the crocodile kind.

*Rodland* looks set to be Storm's third arcade-style smash in a row, following in the shoes of *St Dragon* and *SWIV*. Its strength can only be judged in depth by serious play, then it will be clear if it can live up to its promise and challenge the cute greats of gaming. Could it be *Rainbow Islands'* days are numbered?



immediately above or below. On top of this they have a magic wand which can catch or kill beasties. This combination of special powers and perils makes for some massively frantic climbing and bashing, when the nasties come en masse.

## Over the Rainbow

*Rodland* has that *Rainbow Islands* feel about it, but not in any derivative sense. Both share the same bright look, but it's in the way they play that binds them together. Both allow their heroes to reach higher/further up the screen in order to escape monsters and reach bonuses – *Rodland* with its ladders, *RI* with rainbows.



## How can these people be cute?

If you look at Storm's previous releases as a guide, their preferred game forms look, well, vicious. Both *St Dragon* and *SWIV* were celebrations of excessive overkill, where you impressed folk with the size of your power-ups. So it seems highly improbable that such dedicated followers of fire-power fashion could trade their 'super-fast spread fire' roots for cuteness so easily. Storm's previous releases, though, had some truly vicious game tricks under their not-so cuddly exteriors. Maybe there are tricks even a Special Weapons Interdiction Vehicle will have trouble beating!

More importantly, both games stress standing next to creatures in order to capture them. This enforces good timing and guarantees plenty of credit threatening close calls. Furthermore, to get bonuses you have to manipulate the trapped monster. An act which roots you to the spot for several dangerous seconds.

It is NOT a *Rainbow Islands* clone though. The similarities are only those of strong gameplay. *Rodland* adds further spice to the mix with its large sprites. They don't just look spectacular but also effectively shrink the playing area. And with less space for you to hide in when the going gets tough, precision is essential.

# "WE APOLOGIZE"

*"In our past ads, we compared PageStream 2.1 to Professional Page 2.0 in six key areas. We said that ProPage could not draw Bézier curves. Well, that was wrong. Sorry Gold Disk.*

*We have prepared a more extensive comparison of PageStream and Professional Page. I think users should judge for themselves which Amiga desktop publisher is now the 'king of the hill.' Our first ads were rather lenient"*

*— Deron Kazmaier  
Soft-Logik President*

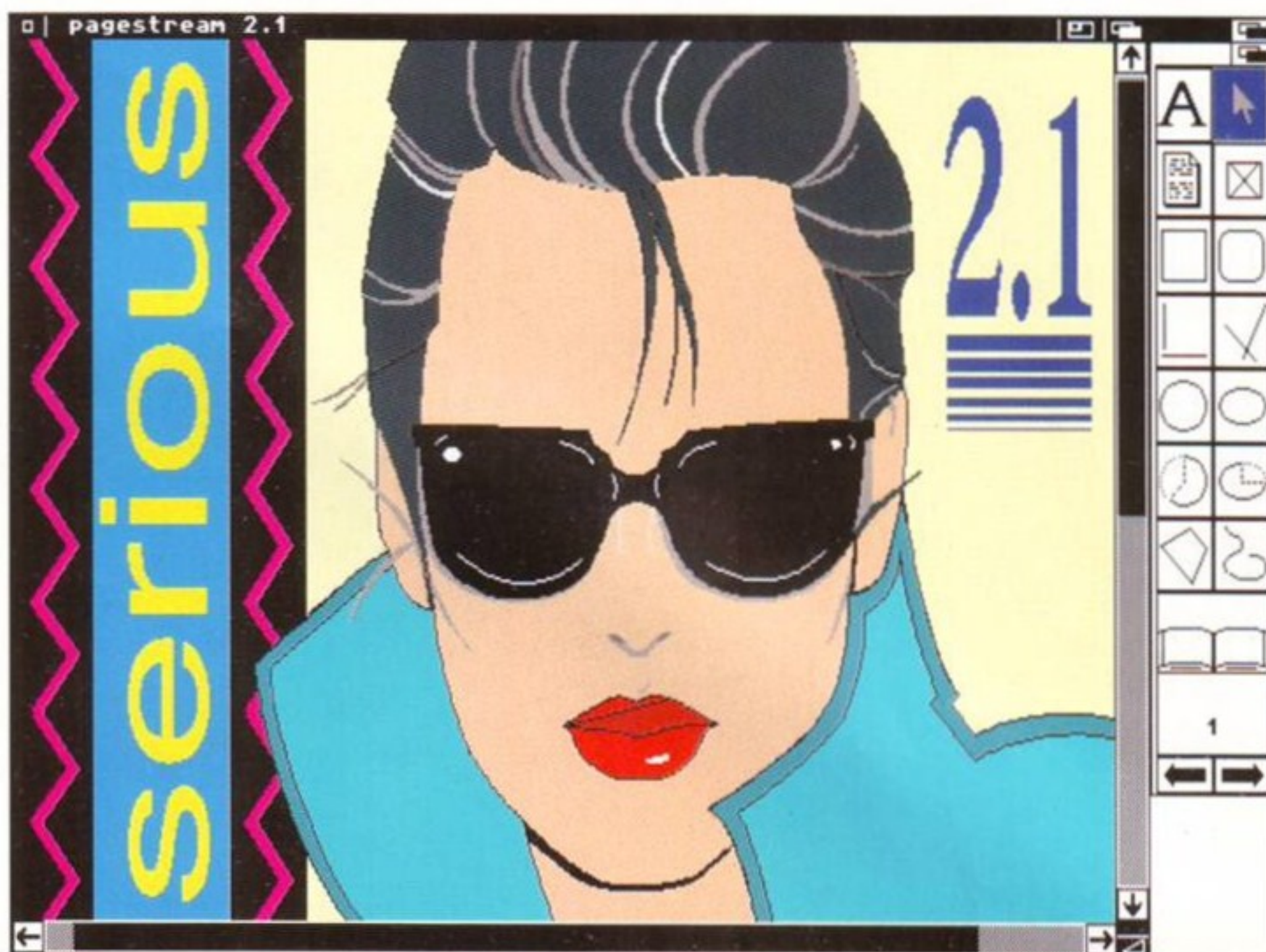

Actual PageStream 2.1 screenshot

ART IMPORT	ProPage	PageStream
IFF (24 bit)	Y	Y
TIFF	N	Y
GIF	N	Y
EPS	Y	Y
EPS - view TIFF preview	N	Y
ProDraw	Y	Y - Editable!
Aegis Draw	Y	Y - Editable!
GEM	N	Y - Editable!
IMG	N	Y
MacPaint	N	Y
TEXT IMPORT		
WordPerfect	Y	Y
Excellence!	N	Y
Scribble	Y	N
ProWrite	N	Y
ASCII text	Y	Y
COLOUR		
CMYK	Y	Y
RGB	Y	Y
HLS	N	Y
HSV	N	Y
Pantone Colours	Y	N
UCR/GCR	Variable	Fixed

FONTS	ProPage	PageStream
PostScript Type 1	N	Y
PostScript Type 3	N	Y
Compugraphic	Y	Y
Outlines on Screen	Y	Y
# Outline Fonts Included	2	18
Typographic Precision	1 point	0.01 points
Max Font Size (any type)	720 points	183,000 points
INTERFACE		
Framed Text	Y	Y
"No Frames" Text	N	Y
# of Open Documents	1	Unlimited
Linked Text Processor	Y	N
Font Caching	Manual	Automatic
View Magnifications	7 fixed	User Scalable
Zoom View	N	15 - 1500%
Templates	Y	Y
Master Pages	N	Y
Measurement Systems	3	9
Maximum Page Size	22x22 in.	1200x1200 ft.
Standard XCV Editing	N	Y
Paragraph Tagging	Y	Y
And the Winner Is...		
Price	\$395.00	\$299.95

*"It's a wonderful but also somewhat sobering thought that the brilliance of your final page is limited by your own creativity and imagination, and not the capabilities of the software you are using. At the end of the introduction in the main manual, Soft-Logik have included a rather poignant message - 'We give you the tools to dream'. I think, with PageStream V2.1, they might be right."*

*— Jonathan Living  
Amiga User International*

**"The new Amiga desktop publishing king of the hill."** — AmigaWorld, February 1991

**"the new heavyweight champion among Amiga desktop publishing programs."** — Amiga User International, April 1991

Soft-Logik Publishing Limited



We give you the tools to dream.

# VORTEX ATONCE-AMIGA

## THE ULTIMATE PC/AT EMULATOR FOR YOUR AMIGA

**£199,-**

Manufacturer's  
Suggested Retail Price

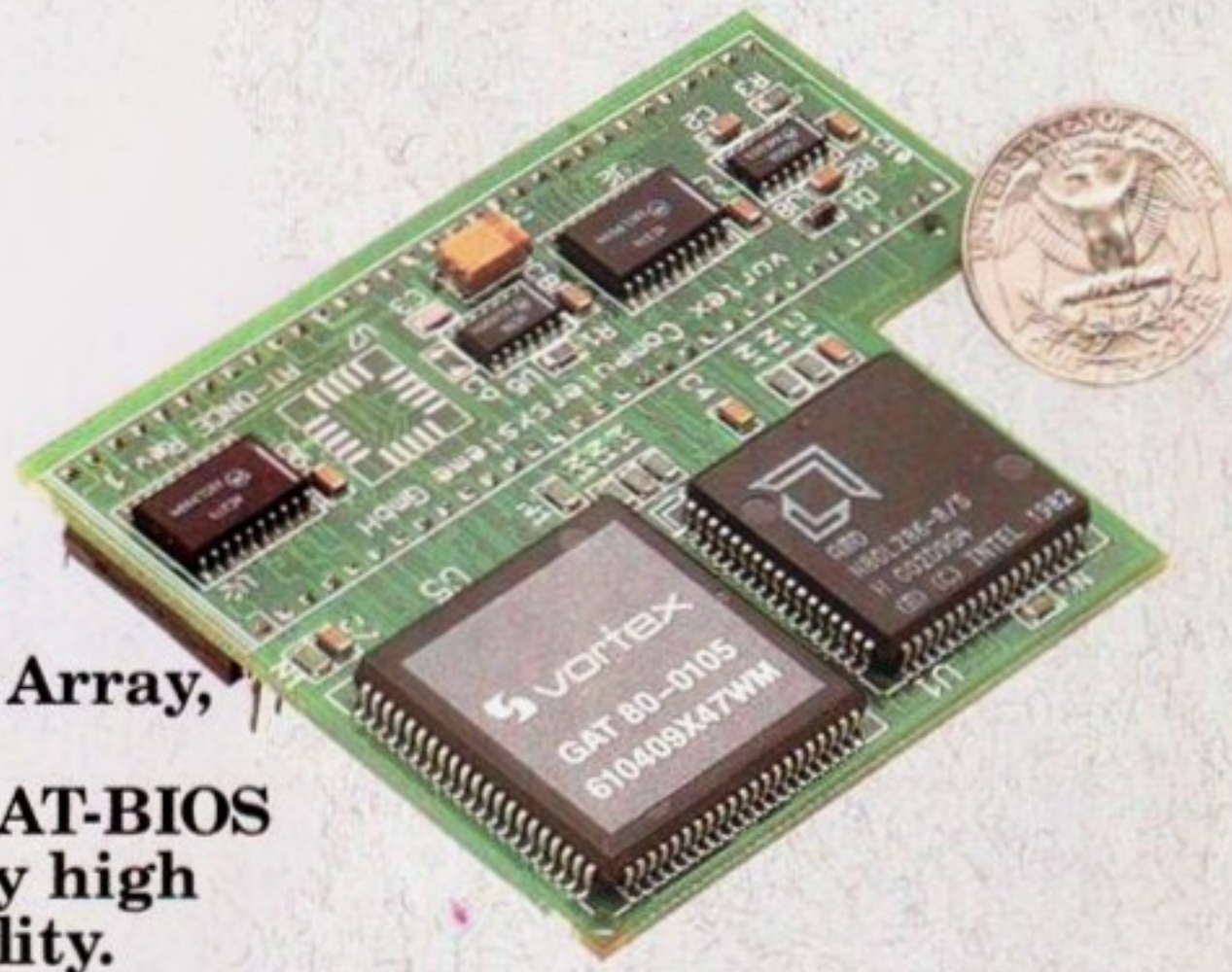

### VORTEX GATE ARRAY

The vortex CMOS Gate Array, the ATonce Chip-Level Emulation and ATonce AT-BIOS give the emulator a very high degree of AT compatibility.

### VORTEX ATONCE THE 286 EMULATOR

vortex ATonce-Amiga is the ultimate PC/AT emulator for your Amiga 500 or Amiga 2000 computer. It is developed and produced in Germany by vortex Computersysteme GmbH. vortex ATonce-Amiga gives your Amiga a complete AT emulation, that includes an AT compatible BIOS, emulation of the parallel and serial ports, sound, colour graphics and hard disk support, yet while running as a task within AmigaDos!

Thanks to the use of the vortex Gate Array and SMT technology the ATonce board is incredibly compact and easy to fit. vortex ATonce-Amiga plugs directly into the Amiga. No soldering is required. Fitting is a 10 minute operation and full installation instructions are included in the user manual.

Each vortex ATonce-Amiga is supplied with a high quality low power Motorola 68000 CPU, saving you time with the installation and providing a high degree of reliability.

vortex ATonce-Amiga does not affect the normal operation of your Amiga and is totally transparent when not in use.

### INCREDIBLE SPECIFICATIONS

- Low Power 16 Bit 80286 CPU  
High quality Motorola 68000 CPU  
7.2Mhz clock speed
- SMT (Surface Mount Technology) compact circuit board with low power consumption and highly integrated CMOS Gate-Array
- Norton SI rating: 6.1  
MIPS Test: 70%
- ATonce-Amiga runs unrestrictedly as a task on the Amiga computer
- ATonce-Amiga will work with autoconfiguring autobootable Commodore compatible hard disk systems that use an AmigaDos compatible hard disk driver
- Full 640KB of DOS memory available on 1 MB Amiga. All memory above 1 MB (e.g. with internal/ external RAM expansions) can be used as Extended or Expanded Memory. The Protected Mode is fully integrated.
- With ATonce-Amiga the following video emulations are available: EGA-/VGA-monochrome-graphics (as far as this is possible with an Amiga), CGA, Hercules\*, Olivetti\* and Toshiba3100\* (\* these modes use interlace)

### MOTOROLA 68000 CPU

Each vortex ATonce-Amiga comes complete with a high quality original Motorola 68000 CPU.

### 80286 CPU

vortex ATonce-Amiga is based on the standard AT microprocessor.

### ACCESS TO 1000's OF MSDOS PROGRAMS

- Complete integration of the internal 3.5" disk drive as a 720 KB MSDOS drive. External 3.5" and 5.25" disk drives are fully supported
- The Amiga mouse can be used as a serial Microsoft mouse. It can operate at COM1 as well as COM2
- The parallel interface can be used as LPT1 under MSDOS
- ATonce-Amiga supports sound, RTC and CMOS RAM
- All MSDOS versions from 3.2 up to 4.01 and DR-DOS 5.0 have been tested successfully
- ATonce-Amiga plugs directly into the socket of the 68000 CPU (Amiga 500). In the Amiga 2000 it is plugged onto the adapter which is fitted in one of the Amiga slots
- ATonce-Amiga is delivered with a detailed user manual. A 3.5" Amiga disk that contains the installation and emulation software is included. DOS and the adapter are not parts of the delivery
- For further information or the update-service, please contact your local Amiga dealer or call Compuserve Box # 100015,330

vortex Computersysteme GmbH - Falterstraße 51-53 - D-7101 Flein - Tel +49-7131-59720 - Fax +49-7131-55063  
SDL - Unit 10, Ruxley Corner Ind. Estate - Sidcup, Kent, DA14 5SS - GB - Tel 081-309 5000 - Fax 081-300 5440

All company or product names are trademarks or registered trademarks of their respective holders. ATonce is the registered German trademark of vortex Computersysteme GmbH.



Currently in progress is a game that will set players the challenge of building a dream world on a barren alien moon. The ultimate aim is to bring the quality of life up by 90 per cent, which should prove to be a real, but enjoyable, problem. There are planning puzzles to resolve, resources to manage, people to be gainfully employed, sports to organise and 10 different alien races to beat off in the mean time!

It is totally mouse driven and the aim is to bring the logistic challenges of colony creation to life in a realistic, isometric 3D mode. Using both icon controls and directly driveable sprites – for tanks and their ilk – *Utopia* should be a high-speed race for domination. The Alien Nation scenarios, where you race and fight strange itinerant species, add the spice while the strategic side adds depth.

At the time of going to press, the graphic interface was up and running but many of the tactical control features have yet to be implemented. It's already clear, though, even on a straight count of the variables, that the game will be a complex animal. It's not just a straight building game or arms race. Different factors will come into play at different points in the game, which should vary pace and playing style to keep this huge task entertaining.

All the strategic options, though, are subservient to the graphics interface, which is why that has received most of the attention so far. Without it there's no useful way to test and tweak the tactical side of play. An outline of the more basic options and how they will affect the game is given below. And even when the pressure's off, and you can study the figures, the potential for variety is staggering!



**Utopia.** This is the display you'll see of the colony. The isometric perspective allows for that 3D feel, while the sprite base allows real detail. To the right will sit the control icons (shown below) by which all actions are initiated.

What makes a good god game? Gremlin think they've found the answer in good housing and alien bashing! But is it paradise?

# Utopia

Publisher **Gremlin**  
Release **Late September**

**Build - Pick a building, any building and slap it on the map.**



**Destroy - Ooops, sorry! Didn't really mean to build that weapons plant next to your house sir! Click on any building to destroy it.**

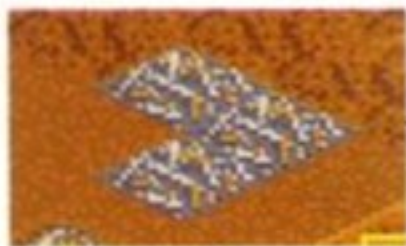

**Finance - This leads to one of the major 'sub-game' sections. Here you balance the colony budget and can also trade commodities to raise more dosh.**

	RES/UNIT	TOTAL UNITS	COST/REP'D	TRADABLE UNITS
FUEL	500	210	100	0
FOOD	100	450	100	0
ORE	200	11	100	0
CEPHS	1	0	100	0
WEAPONS	2000	15	100	0
TECH GOODS	1000	0	100	0
MONEY	46710	0	0	0
INCORP TAX	0	0	0	0

CLICK TO ALTER DATA

## Iconography for beginners

These are the main mechanisms by which the colony is controlled. Each leads to a more detailed sub-menu and serve as an indication of the game's potential complexity.



**Map - Brings up a map of the entire playing area. Used for guiding vehicles and checking their current location.**



**Pointer Placer - Vehicles are always sent to pointers. Pop them on the map if you want a tank or plane to go there.**



**Advisors - Brings up a batch of friendly folk who'll tell you the best place to spend your cash - and why you shouldn't invest it with 'dodgy' merchant banks.**

**Factory - Lets you influence the amount and nature of items produced in the factories. Getting the right people, for the right job is just one of the problems.**

	TECH	REQD TECH	REQD TECH	FORN PROD
ARMY LAB	1	5	40	5
CHEMICAL PLANT	1	5	40	4
FACT	1	5	60	4
SHIP WORK	1	5	20	4
TECH WORK	0	5	20	5
INDUSTRY	0	5	40	5
HOSPITAL	0	5	0	5
LABORATORY	0	5	40	5
SECURITY LAB	0	5	0	5

CLICK TO ALTER DATA



**Spy - Another sub-section, this lets you send out boys to see what the Alien Nations are doing. A very useful source of hints and early warnings.**

**DIGICOM EXCLUSIVE!**

Commodore Amiga A500  
**PRICE CRASH**  
**£299.00**

inc VAT & Delivery

- ★ Includes:
- ★ Amiga A500 512K Keyboard
- ★ Built-in 3.5 DS/DD 1 Megabyte Disk Drive
- ★ Latest UK spec Kickstart 1.3 Machine
- ★ Workbench 1.3, Extras 1.3, Amiga Basic
- ★ 4096 Colours
- ★ Digital Stereo Sound
- ★ Speech Synthesiser
- ★ Notepad Word Processor
- ★ Mouse
- ★ TV Modulator
- ★ ...and all leads to connect to your TV!

**LIMITED STOCKS! - ORDER EARLY**

**Credit Card Orderline Telephone (0908) 378008**

All major credit cards accepted!

**DIGICOM**

Unit 36-37, Wharfside,  
Fenny Stratford,  
Milton Keynes,  
MK2 2AZ

Callers welcome at our showroom - Wharfside is opposite the Bridge Pub on the A5 Watling Street at Fenny Stratford

Move Over 'Screengems' The New Official Commodore Amiga Pack is at Digicom



AMIGA  
500

CARTOON  
CLASSICS

Free 1 Meg  
Worth  
£99.00

NOTICE: The RAM upgrade supplied in this offer is the official COMMODORE A501 Expansion unit. Any other Expansion will invalidate your warranty. Should the fault be related in any way.

The exciting world of graphics, animation and sound is at your fingertips with the Amiga 500. Cartoon Classics brings together a fantastic selection of Cartoon games and a paint package to create your own cartoons.

Amiga A500 Computer Keyboard  
Built-in 1 Meg DS/DD disk drive  
512K A501 Ram Expansion  
Latest Kickstart and Workbench 1.3  
Notepad Mini word-processor  
All necessary disks, manuals and cables  
T.V modulator and Commodore mouse  
4096 colour graphics, 4 channel stereo sound  
12 months warranty on all items  
Full U.K specification machine

Bart vs the  
Space Mutants

The new 1 meg game



INCLUDING THESE NEW TITLES



This years biggest hit



AND THE PLANETEERS

AND OUR OWN EXTRAS PACK

Accessories

Five Game Pack

A Top Title

Mircoswitched joystick  
Disk Library Case  
10 Blank disks  
High quality mouse mat  
and dust cover

Turbo Outrun  
Enduro Racer  
Super Wonder Boy  
Thunder Blade  
Crackdown

Kick Off 2  
1 Meg version  
Voted European  
Game Of The Year



Total Package Price  
Including VAT & Delivery

Next Day Courier Delivery At £5.50 Extra

£399.99

CALL  
NOW

Bart  
Pack 1

Amiga Cartoon Classics Pack as above plus  
Philips CM8833II Colour Stereo Monitor  
plus leads and  
dust cover

£639.99

Bart  
Pack 2

Amiga and Monitor as in Bart Pack 1  
Plus the STAR LC-200 Colour Printer  
complete with  
dustcover and  
leads

£839.99

HOW TO ORDER

By Phone :

Call our credit card order line, and quote your credit card details to our helpful sales staff. We accept Access, Visa, Eurocard, Mastercard, AMEX and the new direct debit cards like Switch and Barclays Connect.

By Mail :

Simply write down the details of your order along with your name and address, then post it to us with a personal cheque, postal order, bankers draft or building society cheque made payable to, "Digicom Computer Services Ltd".

Personal cheques require time to clear before despatch  
Prices and Specifications are subject to change without notice,  
Goods are not sold on a trial basis. E&OE.

DIGICOM

( 0908 ) 378008

36-37 Wharfside

Fenny Stratford

Watling Street

Milton Keynes MK2 2AZ

Showroom open Mon-Sat 9.00am-5.30pm

( closed between 12.30-1.30 pm )

Wharfside is opposite the Bridge Pub on the A5 Watling Street

Digicom offers you !

- Free Catalogue with all orders
- 12 months guarantee period
- All product tested before despatch
- Regular newsletters and special offers
- Technical helpline
- 30 day replacement of faulty product
- Price or product match
- Computerised order system

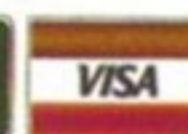

All  
Major  
Credit  
Cards  
Accepted

# THUNDERHAWK

AH-73M

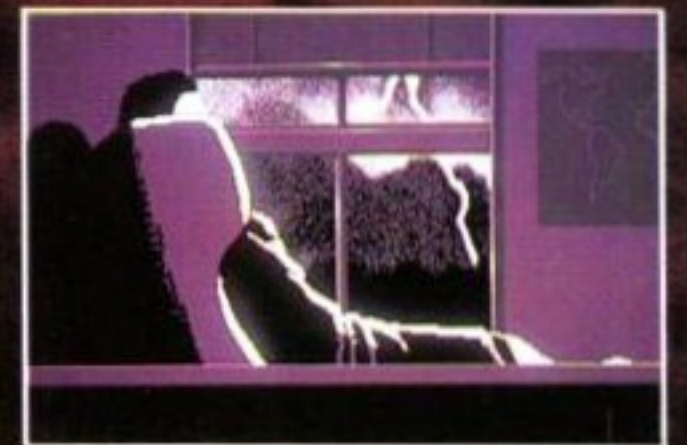
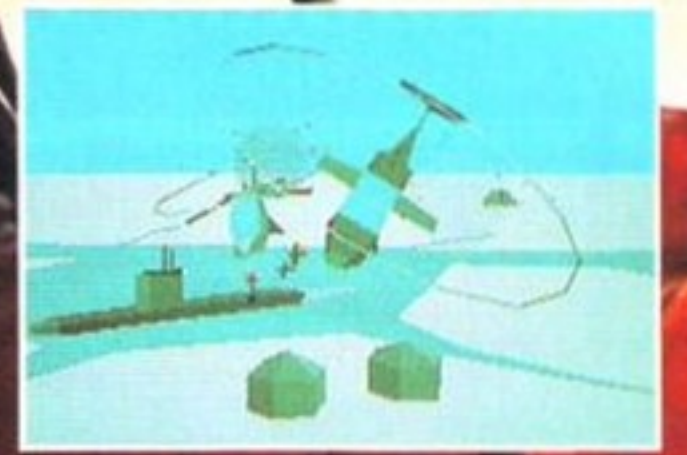

As an élite member of 'MERLIN' you will be employed specifically to defuse crisis situations around the world without provoking full scale war. Control Thunderhawk in what is proclaimed to be "The fastest 3D graphic system to appear on any home computer".

Available on  
ATARI ST,  
COMMODORE AMIGA  
and P.C.

**CORE**  
DESIGN LIMITED



Storming across Europe on a mission of absolute domination

# SCREENPLAY

## Get the Power!



Have ImageWorks gone mad with Mega-lo-Mania? Is this gaming's new top God or a delusion of grandeur? Powermongers battle for Supremacy on P.54

Screenplay is the showcase for all the latest Amiga leisure software. Its brief is to review games just before they hit the shops, to provide the most authoritative and accurate purchasing guide found in any Amiga magazine. You'll find no PC or ST games masquerading as Amiga software here.

The reviews are written by the Amiga Format staffers as well as seasoned professionals, drawn from Future Publishing's crop of market-leading computer titles. This month's reviewers are: Trenton Webb, Maff Evans, Paul Lyons, Frank O'Connor, James Leach, Neil Jackson and Andy Hutchinson.

### Thunderhawk

Gunning for Gunship! P.80

### Battle Chess II

Oriental classic meets pretty pics, but has the gaming gone to pieces? P.71

### Jimmy White's Snooker

Virgin's Whirlwind gets 15 on the Beaufort Scale! Join the cue on P.58

Atomino P.61 ■ Navy Seals P.62 ■ Sliders P.68 ■ Swap P.72 ■ Cardinal P.77 ■ Challenge Golf P.83 ■ Spoutro and Charts P.85

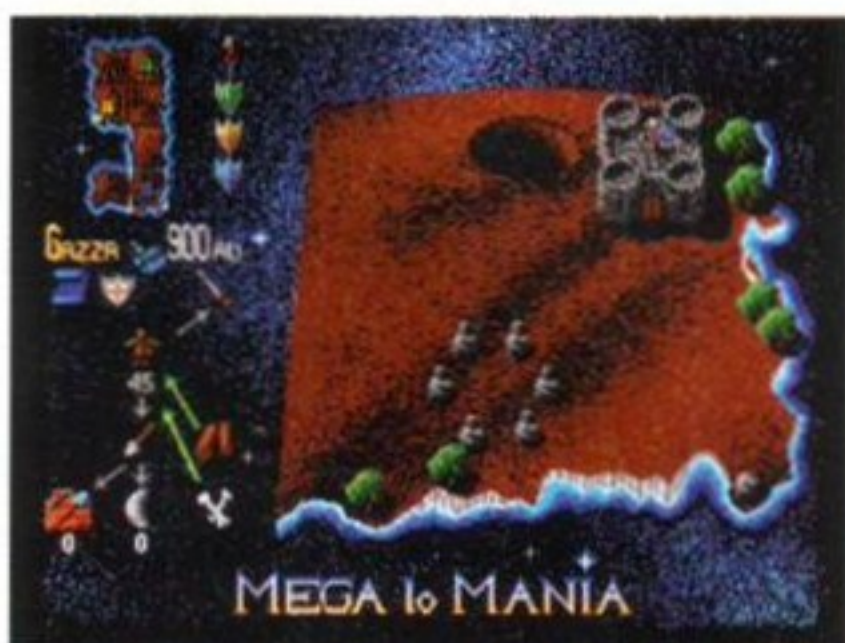

First choose your island. Three make up an Epoch and can be played in any order. Then select the number of men you wish to commit to the struggle. You're given 100 new troops for each Epoch and you have to decide how many and where they'll fight on that island.

On arrival you see the chosen sector with your base tower. To the left of the tower is an open-cast mine, from where your minerals are extracted. At the moment it only yields a few, but it can be improved to give a wider range of resources.

Click on the light-bulb icon in the cluster and you are presented with a list of possible inventions. To invent this shield, click on the picture. When the equation appears, add researchers with the right button. The clock tells you how long it will take to research.

While waiting for the invention to be finished, there's time to look around the island. Click on any sector of the map (top left) to move around. Oh look, Yellow and Green are scrapping, which means your two worst enemies are actually killing each other! Ha!

The numbers by the shields show how many men any team has out in the sector currently being viewed. You can also ask for an alliance by clicking any shield - Yellow here as he has most men - the leader will then appear and give a simple 'yes' or 'no' answer.

The invention is finished and as a result the Blue team advances a tech level. This opens up new avenues - better minerals and weapons! The tower changes design to reflect this. The bricks and mortar icon shows that a mine can now be built.

# Mega-lo



Scarlet

Ferocious leader of the Red Army. She is one nasty lady!

Two faced and very sly, Caesar is the leader of the Green Team.

Caesar



The Green team are ahead in the mining field. They have a covered mine and an open-cast affair. These allow mineral extraction and weapons construction. The open-cast mine is less efficient than a mechanised one, but will do until the Greens rise through tech levels. A covered mine needs building and this takes manpower away from the main war effort.



The Blues have advanced a tech level ahead of everyone else. This will make both alliances and attacks more likely as the competitors fight to nullify this advantage. The high tech level will allow them to build much better weapons (if they have minerals) and therefore gain an edge in combat - if they manage to live long enough to use it!



It looks like *Populous* and has the tactical edge of *Powermonger*. Is it trying to beat the gods at their own game, or is the similarity just skin deep?

Political influence is OK, and military muscle will do, but true megalomaniacs lust after absolute power. *Mega-lo-Mania* focuses on this grim pursuit, but with a smile on its face and with its tongue firmly in the cheek. Have Sensible Software managed to crack it and create a strategy game that's amusing, or are the laughs being used to disguise light-weight gameplay?

## Of cabbages and kings

*Mega-lo-Mania* is a game of minerals, technology and people. Minerals are what's used to build weapons with, technology provides the designs they are built with, while your

people go out and use them on the enemy. Managing all three properly can prove difficult though, in this four-way arms race, because victory is far more important than quality.

*Mega-lo-Mania* is a battle to dominate 28 islands. Each one is divided into sectors and it is here that the minerals come into play. Only one warlord can control a particular sector and extract minerals from it. Because each sector has different minerals, controlling the ones with the best range of elements is important. Without minerals you cannot develop weapons and without weapons: well you're history!

Technology is the driving force behind *Mega-lo-Mania*. Man's trip through the art of

# -Mania



Red is in trouble, real trouble. They have been unlucky in their choice of sector. Going for good minerals they find themselves surrounded by Green and Yellow. Unless they form an alliance with one, or both of them, they will not be able to move out any troops without going to war.



Yellow is playing a strong game. They have a mine and are getting ready to send out a raiding party. If they are going to war, their lack of sophistication (they look like cavemen!) will make them easy meat. They could colonise the sectors below them, though, and build their strength up that way. If they form an alliance they will not be able to build. This a handy tactic when you want to stop another team expanding before you're ready to meet and kill them!

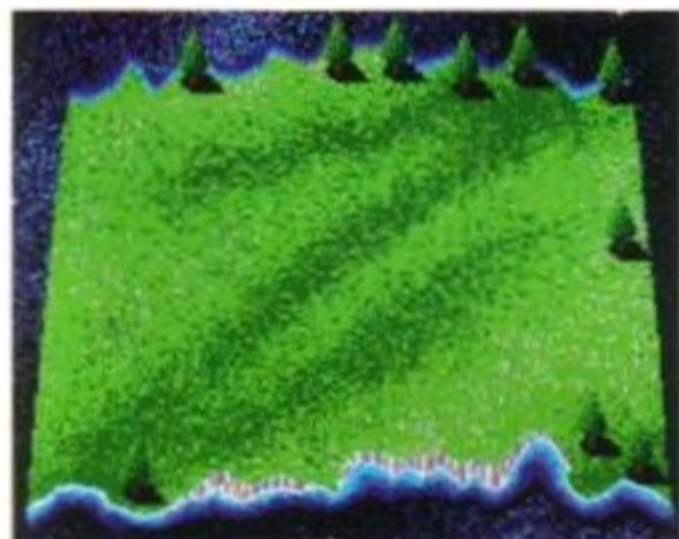

destruction has been split into 10 different 'tech levels'. At first you can only use sticks and stones to break bones. But as the little people gather more minerals, they make scientific breakthroughs and so advance through tech levels. This allows you to build better weapons and gain that vital edge. If you've a cannon then a guy with a stick ain't much hassle, if on the other hand you've got a nuclear missile the man with a cannon's dead meat.

The people you command are stupid. Left to their own devices they'll just collect rocks or sticks and reproduce. It's how you use them that matters - where, when and for what task - that seals your fate. They can be left in the tower (your home base) to procreate, or go out and mine for minerals, work in factories building weapons, research new battle systems or go to war. If you make the wrong call then an



aggressive enemy will simply sneak in an early attack with basic weapons while you are labouring away on the high-level stuff. Alternatively, lower-tech equipment often proves to be all but useless when up against high-tech defenders.

## Island records

*Mega-lo-Mania* is split into 10 levels or Epochs. Each Epoch has three islands, and they share the same starting tech level. It's possible to advance three tech levels above this, so a clever warlord can battle bows with biplanes. All an Epoch's islands must be dominated before you move up to the next Epoch. Knowing which weapons to expect from which minerals at any given tech level forms a vital part of the *Mega-lo-Mania* learning curve, essential if you're to win an Epoch.

Continued Overleaf



**Oberon**

Leader of the Yellow squad, A very violent customer.

King of the Blues, he's very defensive, but plays well.

**Madcap**



The scroll icon will tell you which elements are needed for an invention to be built. The shield icon shows your shield invention can now be built. The 35 men allocated to the bricks-and-mortar mine icon are the folk who are currently employed in building the mine.

Oh look, a mine! That little building next to your tower replaces the open-pit of yesteryear. This building is obvious to all the other players, so they will know of your potential mineral wealth and may attack. It's time to start thinking about weaponry.

Move the hand cursor to the numbers below each icon and press the right button to instruct your people to do a job. Here 10 are digging for Planetarium, and seven are mining Moonlite. The other 36 are sat in the tower breeding until they are given an instruction.

Back in the design cabin, your researchers now have plans for a crossbow defence. Having pulled out some miners means there is a potential force of 47 inventors. The equation shows that this many men will take zero game turns to invent the bow.

Now the bow's finished check out what it's made of. The logs are collected automatically but the Planetarium has to be mined, so some people will need to be put on the case if bows are to be built. The bin at the bottom is used for scrapping redundant designs.

The bows are beginning to roll in, hence the appearance of the Bowman icon, signifying armed Bowman defenders for your tower and mine. Grey arrows show which icons you can currently access, so as Blue has no offensive weapons the sword icon isn't arrowed.





Each defender has to be placed in a turret. Just click on the master-defender icon and then pick the weapon (here it's bows) and place them there. They are well protected and so should see off any wandering villains who try to have a crack at the Blue tower.



A quick check on the minerals situation. The hands show that a mineral is collected automatically and the men indicate that people have to go and dig them out. Unfortunately even the 30 miners produce very few of the minerals, necessary to build Blue's defensive bows.



Looking at the state of the whole island is worrying. Yellow is well ahead of the game with two towers (squares) and one wandering army (dots). Green is on the hoof too, and they are coming this way! Is it time to go to war or perhaps it's better to just sit and hide?



A quick inventing session has yielded a spear for Blue, an offensive weapon at last! The sword icon leads you here. Click on the number below the weapon to start an army. Eleven high-tech weapons (spears) are better than loads of rock throwers, so let's fight.



Once an army has been built the hand changes to a sword, click in any adjacent sector to advance them there. The army is on the march and is looking for an army to fight. Time has been advanced (the man is running) to speed up events click on him to slow it down.



Into the Yellow sector! They were waiting with an equally-armed force of greater numbers. Run away! The numbers by the shields tell the sorry story. This battle is already lost but there will be another day, another battle, another go at Mega-lo-Mania!

Graphically striking, *Mega-lo-Mania* paints quite a misleading picture: it looks like a sprite game!. The weapons, aircraft and little people animate humourously on the full-screen (PAL) display. Yet, although they dominate two thirds of the screen, they only serve as a visual shorthand to relate important information graphically. The game is won or lost with the icons, the miniature map and your fellow megalomaniac's faces.

"Icons systems have to be designed with the player in mind if they are to work well. *Mega-lo-Mania's* control system is clear, intuitive and witty."

Icon systems have to be designed with the player in mind if they are to work well. *Mega-lo-Mania's* control system is clear, intuitive and witty, each icon leading logically to a more detailed breakdown of what's happening in the area it commands. These controls are also reassuringly constant with the right button increasing manpower commitment to an icon, the left decreasing it. Which is just as well as the clicking soon becomes frantic.

*Mega-lo-Mania* literally speaks for itself in the sound department. Anyone who played AF25's Coverdisk will already be familiar with "Zee dezine is feenished," and similar phrases. The full game runs with the speech and either music or sound effects simultaneously, all at no cost to speed. The code loads from disk one, and all the noise is packed onto disk two, which lives in the drive during play - avoiding the need to swap disks. There's masses of sampled speech, all professionally recorded by radio actors who bring real personality and comical speech defects into play. And every time something important happens, the game tells you, personally.

### Nowhere to hide

It's not the effects though that make *Mega-lo-Mania*, it's the gameplay. Each island, tech level and Epoch has its own tricks. As the Epochs start to fall and the tech levels advance, more has to be done, but faster. Furious bouts of clicking, waiting and battling are necessary as the islands begin to get tougher to capture. The computer enemies get more devious, weapons take longer to build and the islands themselves get bigger, offering more places to run and control for all parties. But the gameplay changes as *Mega-lo-Mania* progresses and new tech levels are reached.

Aircraft are the first quantum leap, because with an airforce you are freed from simply advancing and attacking enemies in adjacent sectors. Now you can fly planes to attack anywhere in the island world. Some islands aren't even joined by land and must be attacked this way. On these islands there's a period of relative safety, when defences can be built and alliances made to ensure your survival. The initially slow pace is then suddenly drowned in a frenzied series of air attacks.

When the tech levels reach the nuclear stage, the gameplay once again undergoes a metamorphosis. If you don't develop and use nuclear weapons first then you're radioactive ash. It's a straight first past the post race and

after these bouts of brinkmanship, missile defence networks cut in and the game takes on a far more serious hold. It's a stern test of pure power.

### Lear we go!

*Mega-lo-Mania* is contagious. A finely balanced test of logic and logistics, it grows in complexity without you noticing. The graphics give this tough tactical test a humorous edge,

which is further honed by the speech samples. They don't try to disguise the game's true nature - strategy, not god game - but add real personality to what normally is a dull genre.

*Mega-lo-Mania* pulls you in. Its neat segmented nature means that islands can be played quickly and repeatedly, upping the

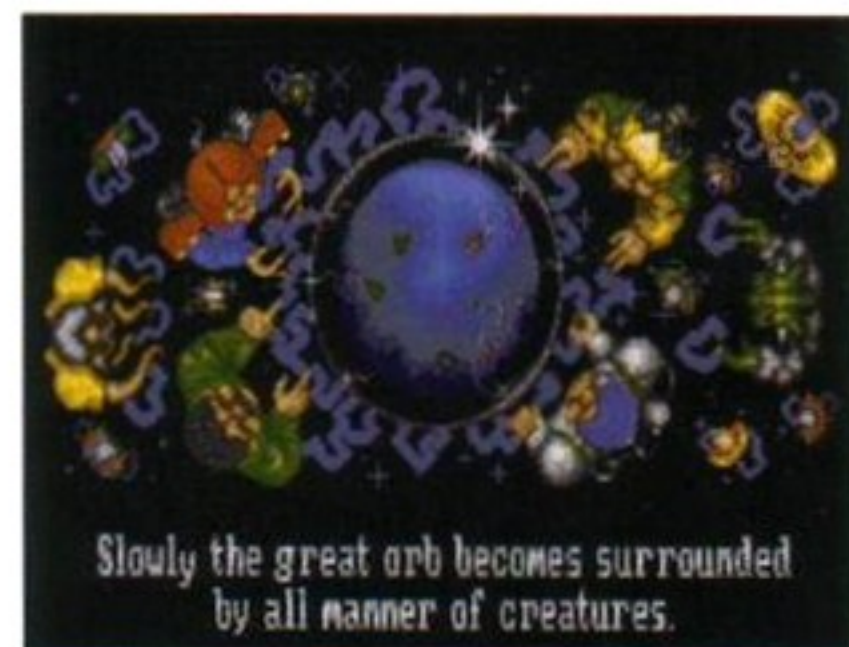

The gods fight for control of this new sector of the universe. This is the setting for *Mega-lo-Mania*, as the winner will become the ever-lasting deity of the people. Theology can wait though, first you have to win all the islands and the mother of all battles!

pace and the enjoyment. This is *Mega-lo-Mania's* true strength: the 'one more go' factor. When this is combined with a never-ending trail of technological carrots, jet fighters, nuclear weapons, spaceships and toys that tempt you into yet more hours of play, then *Mega-lo-Mania* becomes a ferocious strategy challenge but contains an addictive arcade appeal.

Trenton Webb ☺

### Mega-lo-mania Image Works ■ £29.99

- Brilliant use of speech helps create a real personality.
- The gameplay changes in tempo and style continually, presenting new challenges.
- Has that "just one more go" edge.
- Fast-paced strategy that has an arcade atmosphere.





# BEAST BUSTERS

**YOU'LL  
GO WILD!**



Available in August on ST & Amiga formats.

ACTIVISION

Many celebrities have lent both their names and credibility to crass games and must die of embarrassment each time they pass a computer. Jimmy White, though, can hold his head high, because the game entitled *Archer Maclean's 147 3D Snooker* has now become *Jimmy White's Snooker*. The result is a rare mix of a big name, with a big game to back it up.

This latest arrival into the sports arena is a 3D green-baize spectacular. Essentially it's a polygon representation of everything that makes snooker a test of nerve, skill and imagination. It provides an environment where you can check angles, line-up and play perfectly accurate shots. It's not a snooker game, but a true snooker simulator.

Jimmy White himself and three decreasingly skilful pros wait to test your snookering skills in the one-player mode. There's also a trick-shot editor and of course a two-player feature, so you can try your cue against a

When lining up a shot, it's best to use the viewline feature. This projects a line ahead of the cue ball to show which direction it will take if it's hit squarely. If you ask it nicely the Amiga will even show the angle of deflection from the first cushion.

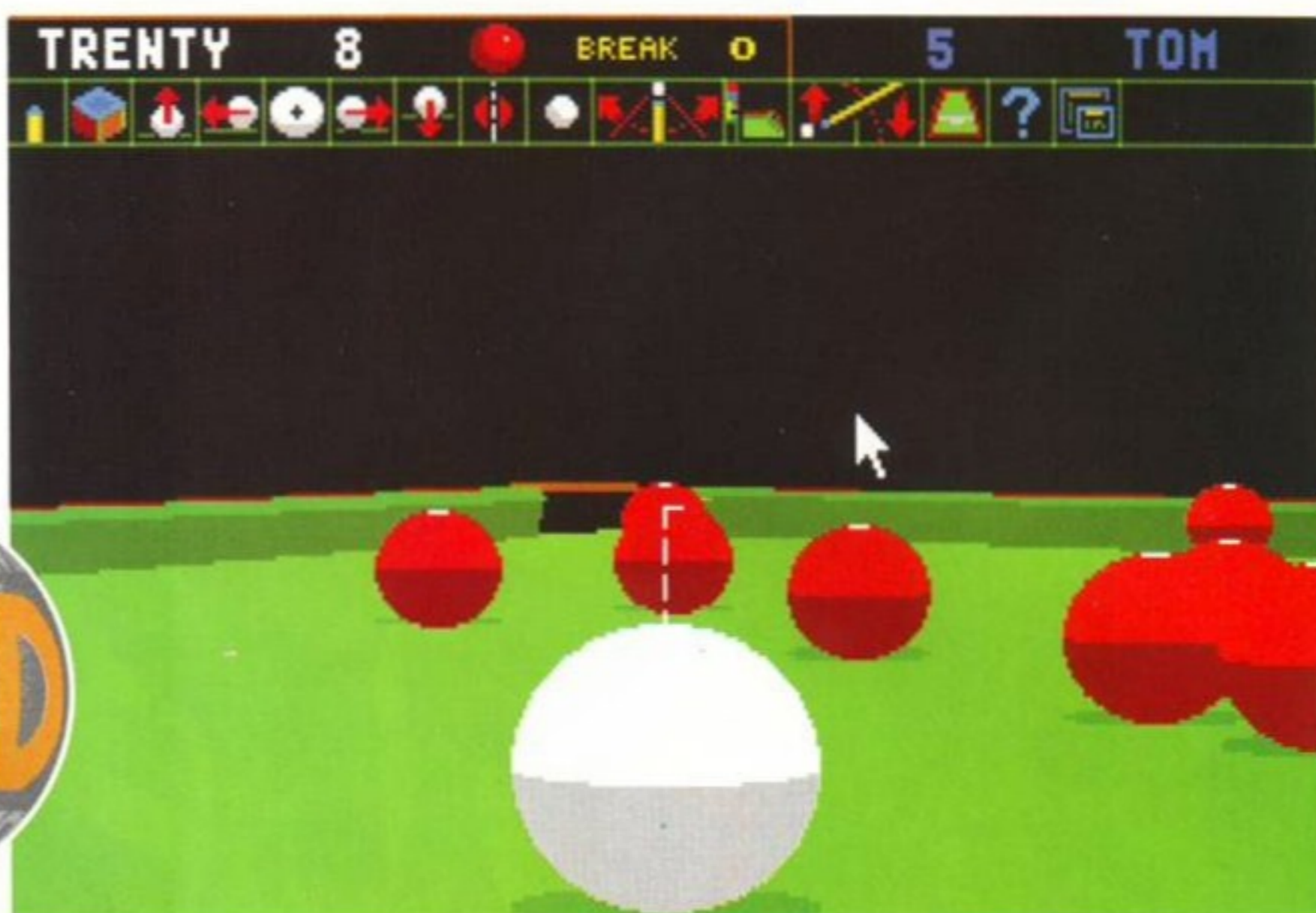

# Jimmy White's Snooker

Welcome to a packed auditorium, where ex-champion Typhoon Trent takes on newcomer Whirlwind White.

friend. The score-board even tells you if you need to play a certain colour, and if so which one, so an encyclopaedic knowledge of the sport isn't necessary before you start potting. The structure of the game isn't what makes the game great though, it's the playing.

### A shot in the dark?

Snooker has a crisp feel to it. The table rolls swiftly in unison with the mouse, so any area or ball can be fully checked out before a shot is taken. A zoom function is only an icon or click away, for a close-up examination or a long-distance look. The table can even be tipped for over-the-top views or an edge-of-the-cushion perspective.

Playing a shot is icon intuitive. Click on the cue ball (or any other ball for that matter) and you're whisked to bridging distance behind it. Using icons or the mouse, you can

roll the table left and right, or up and down to check the angle. Any doubts about the cue ball's line of travel, or how it will bounce off a cushion can be answered by simply selecting the projected line from the menu.

Snooker's about more than cueing in straight lines, though, and the best players will use side or top spin to control the impact and final position of the cue ball. After a squeaky chalk session, you're ready to manipulate the way the cue ball's addressed. Again it's the simple and flexible icons option which adds playability and realism without hampering

- Player name: TRENTY
- Ball required: 8
- Break score: BREAK 0
- 1 Go to cue ball
- 2 View line
- 3 Disk options
- 4 Chalk cue
- 5 Add follow through
- 6 Score info/ Compute best shot
- 7 Left hand side
- 8 Take shot
- 9 Right hand side
- 10 Overhead icons
- 11 Add screw back
- 12 Select plan view
- Change cue power
- Zoom in
- Zoom out
- Tilt table up/down
- Change cueing angle left/right
- Opponent score: 5
- Opponent name: TOM

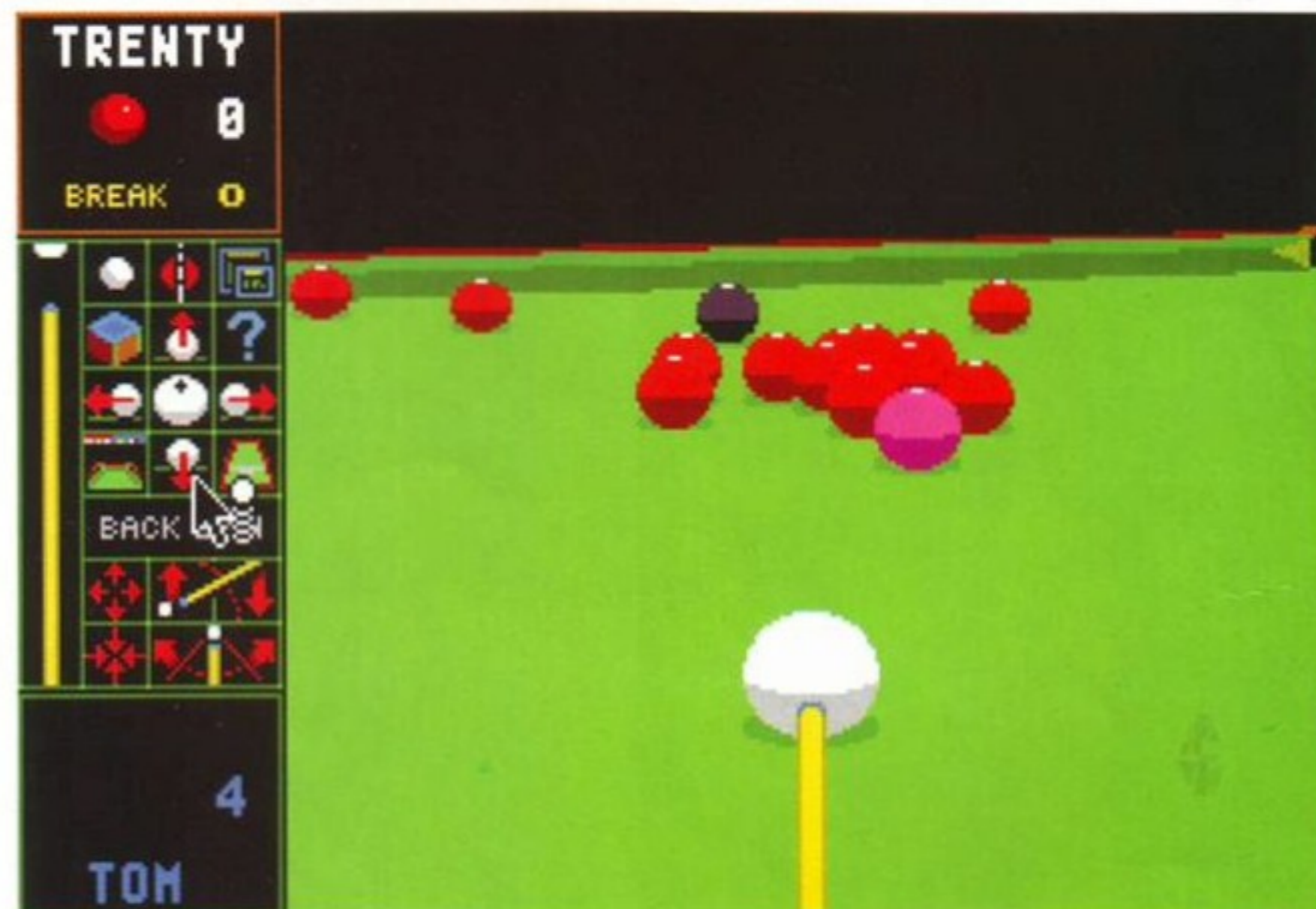

Trenty lines up another stunning shot, this time using backspin. Well it's a safety shot that will hopefully nestle the cue ball in the pack of reds. Not exactly aggressive but effective.



With the cue ball on the baulk cushion, you're in trouble. This is where the mouse driven flexibility of *JW's Snooker* comes in to its own. Rolling around the table you can check the shot from any conceivable angle. If you're in a real tight spot though, it won't make the shot easier to play. You'll just know exactly why you missed!

### Win, win, win!

Even as a single-player game, though, it has a strange and powerful hook. The only thing pulling you into the game is the desire to master the system and win – be it either a computer or a human foe. You want to get better, you want to make bigger breaks, you want to be able – one day – to beat Mr White. Hours and entire evenings melt away unnoticed, though, as you play and play again, gaining an ever better understanding of this snooker system and its particular rules.

*Jimmy White's Snooker* is not without its foibles. The only downer is the slightly unsound potting effect. It doesn't quite capture the sound of a ball falling into a pocket, but you're so relieved it's happened you don't really notice. The lighter side of Mr White's game is odd, but reassuring. If you leave the table unattended then you'll find software flies across the screen. Balls too don't like being left alone for too long as they begin to poke fun of inactive players who are taking too long over a shot. They bring a levity to a serious sim and while they seem somewhat out of place they are endearing.

The strong 3D effects make it all possible

"Expect to spend countless hours unconsciously creeping closer to the monitor, muttering to yourself about top, side, screwing back and kissing balls."

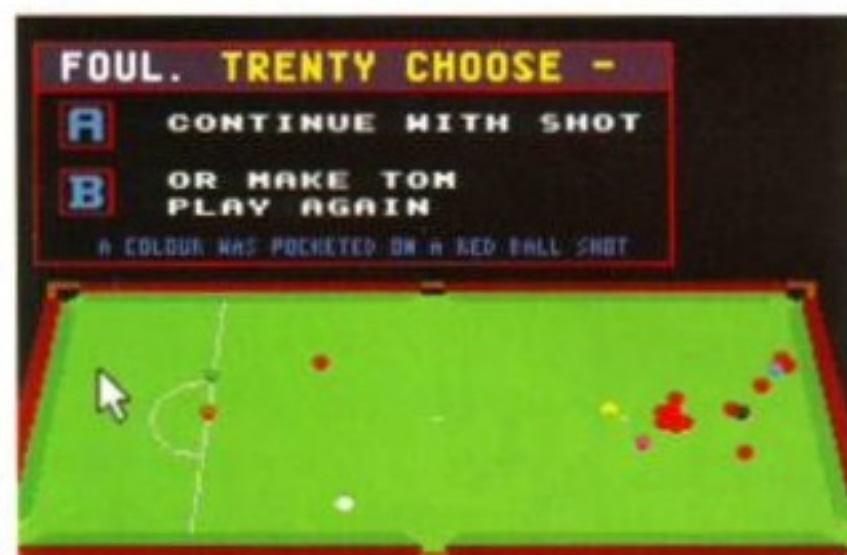

Even the computer fouls up. The fool potted a colour instead of a red. At last some points on the board, even if you didn't score them.



Using the view-line feature helps you to work out doubles. Kind of makes you wish you hadn't potted the red, doesn't it?

speed. After that all you have to do is pick how much power you want to wind into the shot. Then it's time to find out if all the planning was worth the effort.

### Pot luck

Setting up a shot quickly becomes second nature, as does reading the perspective for longer-range efforts. And it's here that *Jimmy White's Snooker* pulls clear of the impressive effects and becomes a game. This is not just a pot and hope job, you have to plan if you want to win. Shots have to be evaluated, assessing to the risk of missing, the safety options and what your next ball will be. These factors have to be taken into consideration, because they are always at the forefront of the computer opponent's simulated mind!

The computer opponents – Tom, Dick, Harry and Jimmy – provide a flexible response to your growing snooker skill. Tom is reasonably useless, only being able to string a small break together and he miscues with regularity. Dick and Harry are pretty sharp, but neither of them will make the cut as hustlers. Jimmy, on the other hand, is unbeatable. He's as good on disk as he is in real life (if not better) and 100 breaks are everyday occurrences.

The computer plays a devious game, calculating every move visibly. This adds character to the opponents and can be used as a source of amusement in its own right. In practise mode the computer can be asked to calculate the best way to pot a ball. If deliberate obstacles are put in its path, you can force the most infeasible shots out of the machine. It's impressive but terrifying, because the

same logic is used by Jimmy when he plays you! No snooker can ever be considered safe!

*Snooker* is a game of touch and judgement. One pixel can make all the difference between a huge break and a shameful defeat. This makes it ideal to play against friends, because both players agonise about a shot's potential success and laugh at its failure.

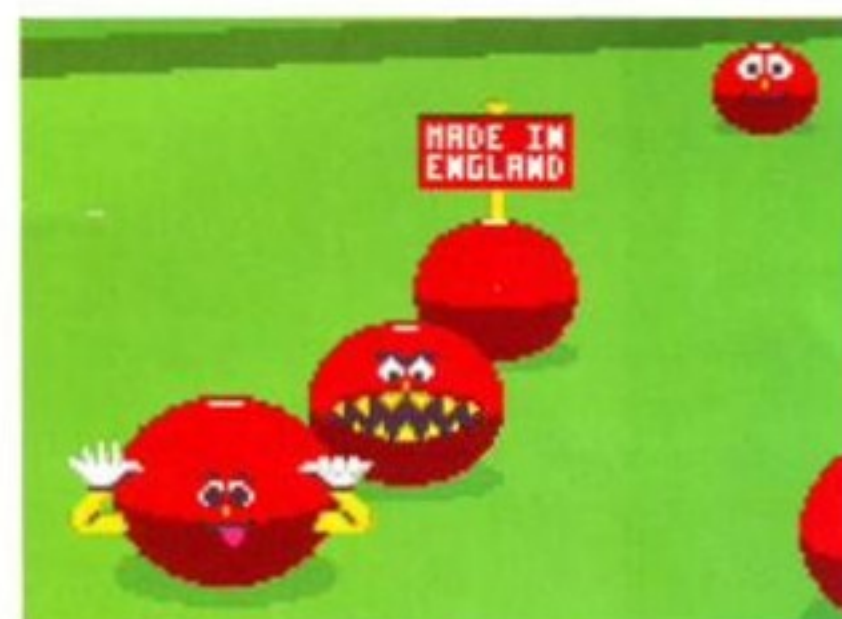

The balls tire quickly of slow players. Inactivity causes some strange behaviour. This is a composite shot of a few of the antics of the snooker spheres. Silly but endearing it underlines the character of the game well.



A trick-shot editor, where you can arrange the balls in any order on the table is also on offer. First this serves as a useful trainer, where you can chase a red ball around the table

until you've mastered the finer points of potting. Later you can build and save outrageous moves, testing the physics of both the game and the coding to the full. In both this and the practise mode the computer can even be asked to calculate the best shot for you! Unfortunately both this and the Undo feature can't be used when you play for real.

and the crafty coding brings it alive. It looks and feels like the real thing. Don't expect to swan straight in and score a 147, it won't happen! Do expect to spend many hours unconsciously creeping closer towards the monitor, muttering about side, screwing back and kissing balls to yourself. *Jimmy White's Snooker* is an absorbing real snooker environment brought onto the Amiga. The sport even seems to benefit from the treatment, as more outrageous viewing angles are offered than the TV could ever dream of. It's the next best thing to dragging a 12 x 6 table into your computer room and doing it for real.

Trenton Webb

### Jimmy White's Snooker Virgin ■ £29.99

- Plays, feels and looks just like the real thing.
- A big name with a real game to back it up.
- Serious code with underlying wit.
- Competition, two player and a trick shot editor.
- Incredibly smooth 3D makes for an ultra-playable snooker simulator.

AMIGA  
Verdict 91%  
FORMAT

# Introducing Saxon Publisher & Draw 4D to the UK...

**Saxon Publisher** provides you with performance unparalleled by other DTP programs, with features so powerful and flexible that even the most complex documents can be created in a fraction of the time. A program that incorporates numerous advanced typesetting features not available anywhere else - at any price. Saxon Publisher will change your perceptions about what a truly professional DTP program should be...

## The DTP Standard for the Amiga

- ✎ Text sizes up to 2000 points
- ✎ Import text from any Amiga WP
- ✎ Rotate, Scale and Skew text in any direction
- ✎ The ability to import and print 24 bit images without conversions utilities
- ✎ Support for Encapsulated PostScript

**SKEWING**

**ROTATION**

**Draw 4D** is the first Multi Dimensional Structured Drawing and animation software for Desktop Publishing and Video.

The interface is the fastest, smoothest and easiest to use available on any computer.

- ✎ Zoom range is nearly unlimited
- ✎ DRAW 4D is fully multitasking



## PICTURE DISTORTION

Saxon Publisher V1.2....£249.95

Draw 4D....£149.95

Saxon Publisher/Draw 4D Package...£349.95

## ...and the New Supra Range

**SupraDrive™ Floppy** quiet reliable floppy disk drive works with all Amiga® computers. 1MB unformatted capacity. Pass-through port for connecting additional drives...£89.95.

## SupraDrive™ Removable

Syquest™ removable cartridge drive for the A500 or 2000. Great for primary & back-up storage. Comes complete with SCSI interface, or as add-on drive. INTERNAL £599.00 EXTERNAL £599.00

**SupraDrive™ 500XP** Micro-power hard drive, SCSI interface, & RAM for the A500. Easily expands for 1/2 to 8MB RAM. Includes Amiga bus pass-through, SCSI port, software. From £425.00

**SupraDrive™ WordSync™** Easy-to-install, autobooting hard disk card for the Amiga 2000. Uses high-performance Quantum™ hard disk & includes SCSI port, utility software. 40MB £425 · 52MB £475 · 105MB £625

**SupraRAM™ 500RX** 1/2, 1, 2, 4 or 8MB of FAST RAM for the Amiga 500. Easy to expand. Zero wait states & hidden refresh. Amiga bus pass-through. from £129.95

**SupraRAM™ 2000** 2, 4, 6 & 8MB of FAST RAM for the A2000 & 3000. Easy to expand. Zero wait states & hidden refresh. Four-layer board improves reliability. From £119.00

**SupraModem™ 2400** 100% Hayes™ - compatible 300, 1200, 2400 baud modem for virtually all computers. Compatible with all popular telecommunications software. £149.95

**SupraModem™ 2400 Plus** SupraModem 2400 with MNP5 & V.42bis error correction & data compression protocols. Allows transmissions up to 9600 bps. £199.95

**SupraModem™ 2400zi** Internal half-card modem for the Amiga 2000 & 3000.

Installs easily in any Amiga bus slot. Supports multiple modems on one computer. From £119.95

*All modems have a five year GUARANTEE*

**Supra Corporation**

All prices include 17.5% VAT.

Dealer enquiries welcome

Access & Visa Welcome

**Surface**  
UK Limited

SURFACE UK LIMITED · 5 ROCKWARE AVENUE · GREENFORD · MIDDX UB6 0AA  
TELEPHONE 081-566 6677 EXT 204/205 FAX 081-566 6678

**D**o you remember school chemistry lessons? All that talk of atoms, molecules and valences when all you wanted to do is mix things together and see what happens (preferably from a safe distance). Well with the first puzzle game from Psygnosis since *Lemmings* you are given the power to mix your own molecules, without all that tedious attention to real chemistry and its unpredictable consequences.



The first few levels are ideal for practising your nuclear construction technique. This large molecule needs two more atoms on the left to end the level for a serious bonus.

Your task is to combine atoms to form molecules and there are four kinds of molecule, each with a different number of connectors (or valence number). To create a molecule all you have to do is connect two or more atoms together so that all the connections are made and it's as simple as that. Well actually it's not quite that simple at all. To add a bit of life to the game you have to add the atoms to the playing area in the order that they appear in the supply chute.

### Molecular madness

There are two modes of play: in one you simply have to create as many molecules as possible, competing only against the steadily-increasing flow of atoms. In the other mode,



Welcome to level 50 - now things start to get really tough. Your task is to remove all the screwed-down atoms by linking them into molecules. The problem is that new atoms are appearing in the delivery chute almost as fast as you can place them.

each level has a specific task that has to be completed before you can advance on to the next level. 'Create X molecules with at least Y atoms' is self-explanatory. The 'Remove the given atoms' challenge involves creating molecules around already present atoms, often screwed to the board preventing their movement. The most fiendish task is 'Complete the given pattern' one, where you have to create a single molecule that fills the whole of the playing area.

As the game progresses through the levels, the playing area gets smaller and changes shape so the atoms have to be placed faster and faster - if the seventh ball falls into the supply chute, then the game is over. It may

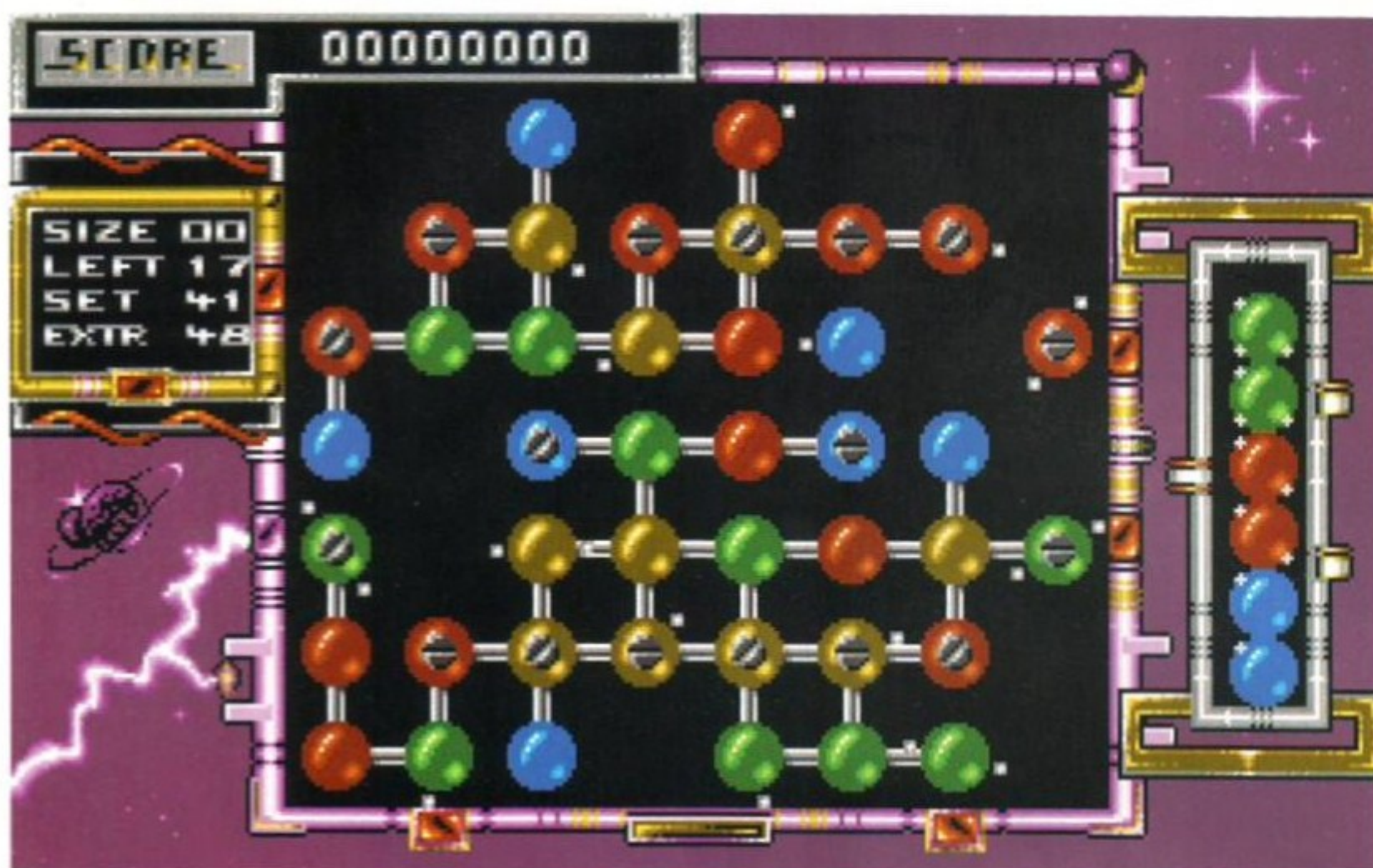

Eek! What's going on? Level 50 looks complex but don't worry, when you get here you'll be a seasoned player. All you have to do is make connections between all of the atoms. Unfortunately you're not doing too well...

# Atomino

all sound terribly complicated, but after a couple of levels everything becomes clear - if no less frustrating.

On the down side it lacks the attention to detail that is usually attached to Psygnosis' releases. The difficulty factor of the levels is pretty uneven and the fact that passwords are only given every 10 levels makes advancing from levels 50-80ish a needlessly frustrating task. The soundtrack and background could have benefited from the occasional change à la *Tetris*. Most annoyingly, there is no facility for mouse control, an option that would increase the playability no end.

### Atomic atrophy

In the long term, like many puzzle games, *Atomino's* lastability suffers because of the game's repetitiveness. Although coming back to the game is an enjoyable experience, it lacks the ability to make you want to pick it up again. On the whole, though, it is a fast-paced and deeply absorbing game.

The trickiest levels are those where you have to make a single molecule fill the entire playing area. Think very carefully before acting: if you fill the area too fast, without making all the links, it'll be 'Game Over', man.

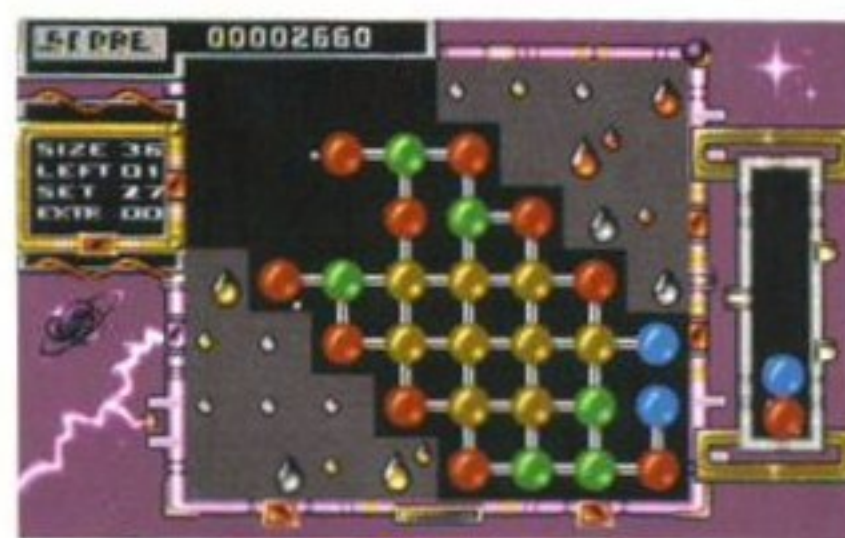

If you're a serious puzzle fan, or if you're looking to add a good-quality puzzle game to your collection, then *Atomino* has much to recommend it. Unfortunately it doesn't quite have the hook that makes a good game into an essential buy.

Paul Lyons

### Atomino Psygnosis ■ £25.99

- A fast-paced puzzle game requiring good forward planning.
- Pleasantly functional graphics and spot effects.
- Sadly there is only one tune throughout the game.
- There is not an option for mouse control, which would of helped.
- It all becomes somewhat repetitive after a while.

### Meet the molecules.

1. The single valence atom, useful for capping the ends of chain molecules. Among the most reactive of elements, single valence atoms include hydrogen and sodium.
2. The red two-valence atom is particularly useful in forming corners on a molecule. Magnesium is a two-valence atom - pretty reactive under the right conditions.
3. The green three-valence atom is very good against the side-walls, but they should be kept out of the corners. They are dull but useful, three-valence atoms include boron and aluminium.
4. For that truly porky molecule, lots of four valence atoms are very handy. In real life these are represented by silicon and carbon, two of the most plentiful elements in the world.

AMIGA  
Verdict 72%  
FORMAT

Ocean's latest is based on the God-awful movie of the same name. The movie tells the tale of a group of top-secret super agents, much in the same mould as Britain's SAS. The game follows the plot of the movie fairly loosely and sees you controlling a group of five American soldiers. There are two main objectives: to rescue the occupants of a recently shot down helicopter and then destroy a stockpile of missiles.

The game is set in the Gulf region, possibly bad timing in light of recent events there. Basically, it involves a lot of platform action,



Swinging precariously along a balcony, you have to deal with the machine-gun wielding goon above you.

interspersed with some noisy shoot-em-up bits. The screen scrolls in four directions and most levels are fairly complex.

### The American Dream

As you wander around the screen, you will come across crates that are stamped with an American flag. These contain missiles. Walking over these crates activates a timed explosive device. To complete a level, you must find all of the missiles and plant the explosives on them.

Hampering your progress in this matter, are lots of Arabian soldiers. These guys will shoot you on sight, but only if you are directly in their line of vision. Your Navy Seal dude

It's basically a platform shoot-em-up, but the second level is a lot more maze-like than the first and it may be wise to make a map. Here a massive explosion ensues as you shoot an unfortunate Arab geezer with an unfeasibly dangerous bazooka.



# Navy Seals

Crawling away from the bad guys, like the damned coward you are. You should kill that bloke and get hold of the juicy weapon hidden inside the crate. Weapons range from crap sub-machine-guns, to an impressive flame-thrower. Babes flip for flame-throwers.

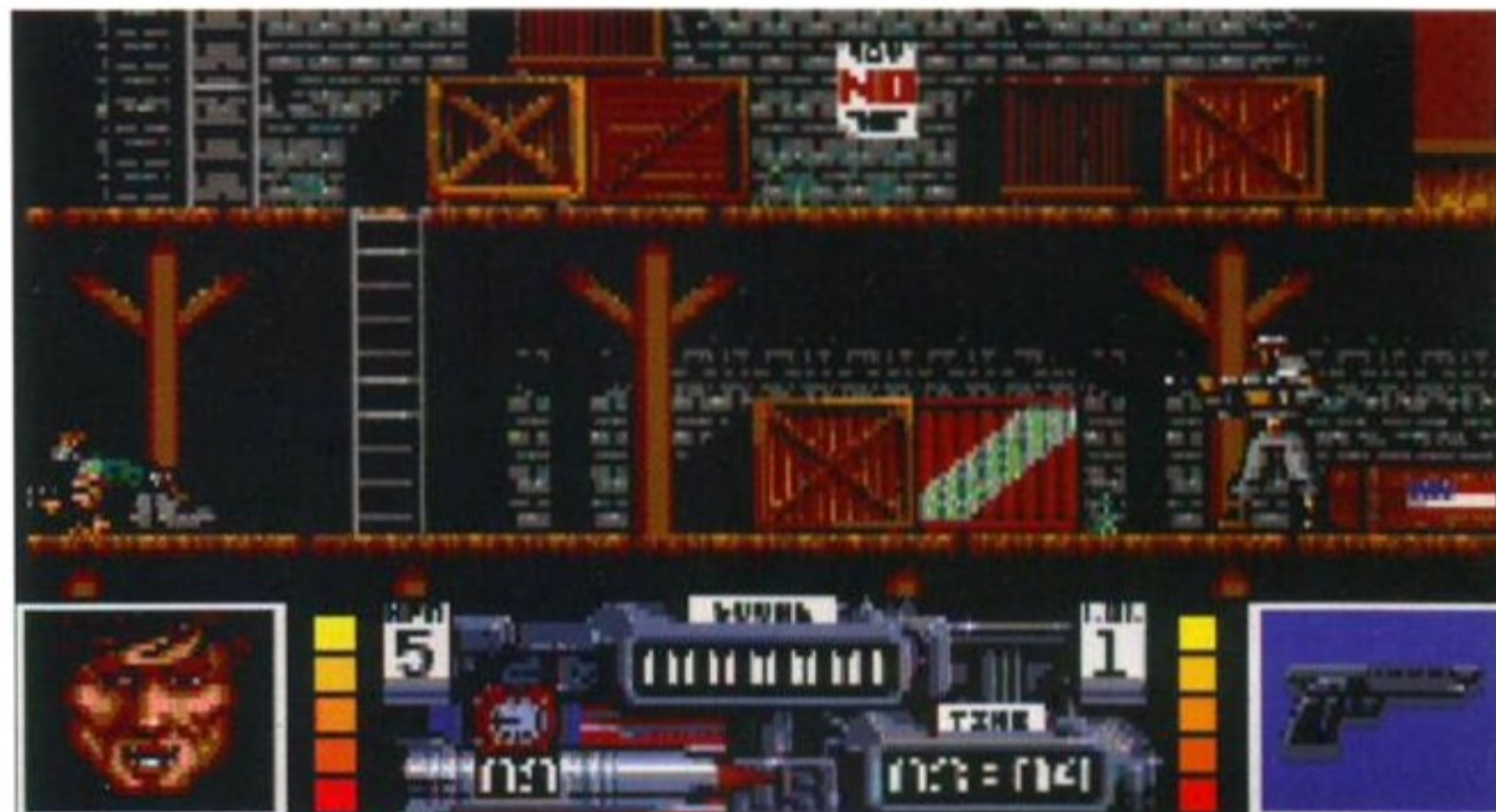

That fellow in flames has just been torched by your lovely flame-thrower. Don't worry too much about morals here.

## NAVY SEALS vs SAS

Everyone knows how hard the SAS are. They are often to be found scaling walls, fighting Russian kung-fu masters and biting the heads off Doberman pinschers. SAS troops tend to live life to the full, seeking danger and excitement wherever they may be.

In light of this, we thought it might be a nice idea to run a comparison between the SAS and the Navy Seals.

Having no idea what the Navy Seals actually did, we contacted their top-secret HQ in North Carolina and spoke to agent Dave "Spanky" Scheinfeld. We told him about the SAS and asked him how he thought the two sides compared.

"Frankly," he said, "We really enjoy sitting in and watching a bit of Oprah Winfrey. All that danger stuff is a bit stressful for us." Pausing for a moment, he added, "The action in the movie isn't like us at all, we much prefer a bit of male bonding. We're also very keen on personal hygiene".

So there you have it. The authoritative guide to the world's most dangerous secret agents.

can perform some fairly athletic manoeuvres on the obstacles and platforms. It's quite easy to knock out one of the enemy by jumping on him or swinging down right onto his bonce from a platform.

The main problem with the game is the difficulty level. If an Arab dude spots you and opens fire, it's almost impossible to avoid the bullet, mainly because your sprite is so slow to respond. The instructions on controlling your hero are a little misleading, but once you figure it out it gets to be quite enjoyable.

### Sights and sounds

The graphics are pretty, but they lack variety and the urge to see what lurks on the next level. The sound is fine, neat spot effects and decent samples. It think it could have benefited with some in-game music though.



In the elevator, and it looks like you're lost. Jump off to reach the next missile.

Navy Seals isn't a bad game at all, but there are so many niggling problems, it seems a shame more time wasn't spent on it. With some thought and good design, this could have been a brilliant platform game. As it is, Navy Seals is average.

Frank O'Connor

## Navy Seals Ocean ■ £25.99

- Tricky platforms and irritatingly frequent death causes some unnecessary frustration.
- Variation between levels is almost non-existent.
- Graphics are decent, marred by some odd animation.
- A reasonable licence, making use of a tired old formula, but not the worst of its kind.

Verdict 65%

# VIRTUAL WORLDS™

THE 3D GAME COLLECTION

In just five years Incentive Software have built a reputation for producing the very finest in 3D exploration games. Their development systems Freescape and Freescape 2 have become synonymous with quality, depth and playability. These four games represent the pinnacle of their success. We hope you enjoy them.

What the press have said:

## DRILLER

One of the best ever – 90%  
– ZZAP! 64  
Dazzlingly original – 963 – ACE  
Generation 4 (France) – 98%

## TOTAL ECLIPSE

All the addiction and challenge you can handle – 907 – ACE  
Incentive have done it again – 93%  
– CRASH  
Micro Hobby (Spain) – 90%

## CASTLE MASTER

The best Freescape game yet – 90%  
– C&VG  
Easily the best – 90% – THE ONE  
Joystick (France) – 96%

## THE CRYPT

The Crypt has never before been released. An immaculate follow-on from Castle Master, Incentive at their very best.

AVAILABLE ON: IBM PC 5.25" & 3.5", Amiga, Atari ST, CBM 64 cass. & disc., Spectrum cass. Amstrad cass. & disc.

Screenshots taken from Amiga version.

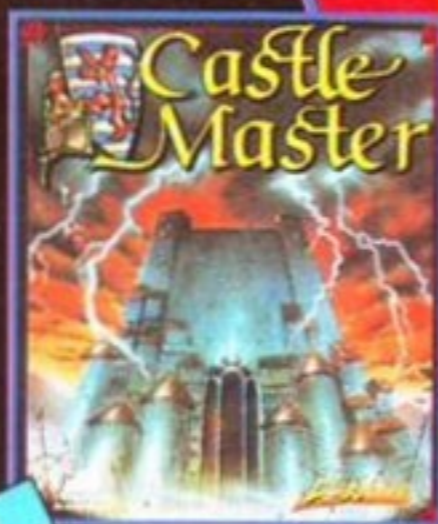
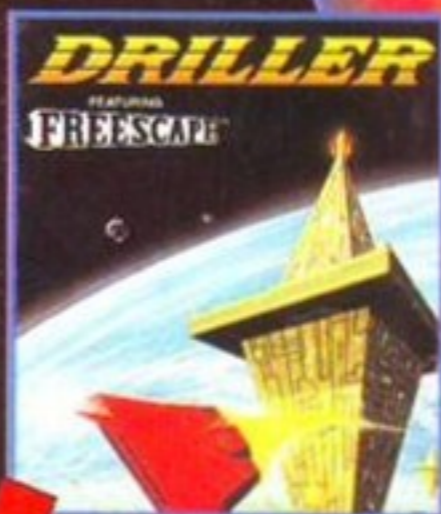

# DOMARK

**incentive**  
The Award Winners

**The Crypt**  
CASTLE MASTER II

All games designed by Ian Andrew. Castle Master and the Crypt programmed by: Chris Andrew, Paul Gregory and Sean Ellis. © 1990 Copyright Incentive Software. Total Eclipse programmed by: Chris Andrew, Paul Gregory and Sean Ellis © 1988 Copyright Incentive Software. Driller programmed by: Chris Andrew, Sean Ellis and Stephen Northcott © 1987 Copyright Incentive Software. FREESCAPE® is a registered trade mark of Incentive Software. Incentive Software is a division of New Dimension International Limited. All rights are reserved. Licensed to Domark. Unauthorised copying, hiring, lending, performance, and broadcasting are strictly prohibited. New Dimension International Limited, Zephyr One, Calleva Park, Aldermaston, Berkshire, RG7 4QW. Artwork and Packaging © 1991 Domark Software Ltd. Published by Domark Software Ltd, Ferry House, 51-57 Lacy Road, London SW15 1PR.

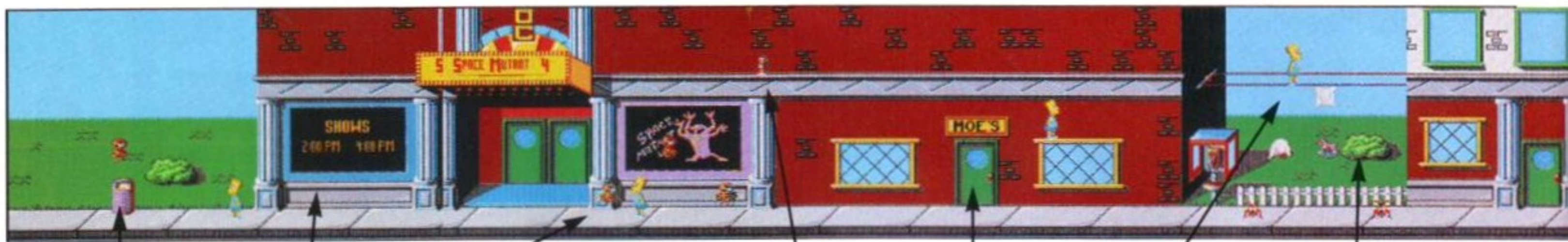

Try jumping Bart on the bin for a spring surprise, but watch out for that horrible orange nasty

Shows at 2pm and 4pm? Well 'Bartlock' because it sounds like a big clue to me.

Three nasties and a purple sign. The three have to be avoided and the sign needs spraying.

Ah! A can of spray paint but how do you reach it without leaping back into the aliens?

A locked door, well intriguing or what! Maybe there's a key somewhere later on. Or maybe not!

Its SpiderBart! Just by leaping on a local phone booth he can reach safety and those towels.

Hint number two - there's an extra life in them there bushes. It's getting it and staying alive.

Living on Sky TV has hardly earned Bart Simpson mass exposure, but the yellow peril is still popular. The Simpsons, it seems, can sell everything, from T-shirts to satellite dishes, a fact which led the more cynical members of the press (Damien included!) to voice doubts about the potential quality of the game. Bart himself may be an "underachiever and proud of it", but the game most certainly isn't!

Radical man

The Simpsons comes in console flavour, packed with Super Mario-style platform leaping, timing traps and hidden bonuses. Few console games have made the transition to computers with grace, losing their playability somewhere between cartridge and disk, but Bart retains his charm.

Bart, resplendent in garishly bright cartoon colours, has a simple mission - to save

This is a real cruel little timer to get right. The mutant scurries left and right either side of the drinking fountain. Bart has to sneak in and get spraying. He's not as fast as the mutant, though, so go real, real careful or you'll find out where cartoon kids go when they die! Probably to the BBC!



# The Simpsons



This is what Bart sees with his X-ray bans on. Pull down on the joystick to call it up. To the right, Bartie is discovering his specs.



Big name hunting can be a perilous task these days. Has *Bart Simpson vs the Space Mutants* survived?

the Earth! Having watched aliens invade his back yard he sets out to become the saviour of Springfield. The aliens have 'bodysnatched' a whole bunch of people not only this but they have planted a number of baby monsters who bounce around on guard. The final part of the attack is far more subtle, the Space Mutants are building a super weapon! For this they need purple stuff and all manner of curious kit. Don't ask daft questions like why? This is the

Simpsons and the logic is natural, even if it's not exactly sensible.

Bart, while leaping and running along a horizontally-scrolling town, has to spot the bodysnatchers in a *They Live* parody. Whenever he pulls on his X-ray specs he can see the tentacles looming out of what looks, in regular vision, to be a normal human head. Jumping on the head in question kills the 'proof' and wins him a gem. (Obviously

The mutants are always changing speed so look before you leap.

Bart needs that extra can, so dodge the alien and walk along the window.

Candy may be dandy, but all the canopy needs is painting!

Once again a bin really comes to your aid, bounce again Dick Whittington.

There's a purple parrot in that window, a real teaser to get hold of!

Walk on the grass by jumping. This gets the purple policeman on.

Dodging the Policeman, though, is hard. Leap back on the grass, quick!







A hive of bees lives in this bush. Leaping up for a bonus will cost you a life, so take care.

Check out the bush by jumping up before you leap over the nasties, there's cash to be had.

Scope that guy out and Bart will find that he's an alien 'proof'. Jump on his head to get a gem.

Pushing up in front of some shop doors lets Bart in, some items are vital so buy carefully.

Spraying that plant is tricky. Stand to the left of the window ledge and paint as you spray.

This plant is even harder to reach, try jumping on the door but watch out for the mutant.

The clown token is an extra life and is well worth getting even for a cartoon character.



Level Two and Bart's at the Mall. Here he has to catch hats that fall from the ceiling. It's tough, but try not to jump on the head of any humans or you'll lose another life.

stops them building a super weapon. Each requires different skills to keep and collect if the aliens are to be robbed of their ingredients.

**Aye carumba!**

Bart isn't perfect. The sprites are small, the colours retina-damagingly bright and a rendition of the Simpson's TV tune echoes throughout the entire game. These are niggles don't hinder the playing of the game, which is where Bart's strong points lay.

Above all else *The Simpsons* is highly

*"The Simpsons isn't a brilliant game: it is a good game which uses its licence well."*

playable. Its pretty front-end graphics demand you watch, then the well balanced gameplay cuts in. First, the puzzles intrigue while the timing tests add tension, then as expertise grows and the level's brushed aside, exploration and experimentation become possible.

The hidden bonuses and disguised traps are worth hunting for, as are the warp screens. There's even a safety net system, which allows observant players to recover from earlier mistakes. These features don't make *Bart vs the Space Mutants* stunningly original, just solid, with enough varied elements to ensure that attention is paid to each new screen.

*The Simpsons* isn't a brilliant game, but it is a good game which uses its licence well. It draws on the resources introducing 'real' Simpsons incidents. On top of this it has an addictive edge, even to folks who have never seen a living Bart in their life.



Ahh it's the purple policeman! Leap down to spray the man and then get out of his way. It's a tough job being an underage superstar.



A gratuitous piccy of Bart, looking bored. He's been confined to his room (again) and it's here he sees the alien invaders.

jumping on the skull of a normal human is frowned upon and so costs Bart half a life.) If enough gems can be grabbed then the other Simpsons can drop in one by one to lend a hand at the end of the level: and in force on Level Five.

really scores. The puzzles are simple but feature fiendish variations around a common theme. Well judged in distance and tempo, these push Bart's leaping and running abilities to the limit. They also ensure that even when a level has been explored inside and out, you'll still be leaning in your chair to encourage the sprite to safety.

Painting things 'unpurple' provides *The Simpsons* with its puzzle platform. Bart can grab spray cans and then use it to change a dangerous item's hue. Life, especially for Bartman, is never that easy because every item is guarded by a space mutie.

Certain items it seems are unreachable, even with the bravest leap. These have to be manipulated by remote means, forcing Bart to visit shops and buy and use tools to change their hue. All the active objects on a level have to be rendered safe if Bart is to proceed, again adding an extra tweak to the gaming process.

The Mutants are after purple kit on Level One. Later they hunt hats, balloons, exit signs and other weird items as Bart systematically



Wow, Man!



Don't have a tree!



Spooky Aliens!



World saving time!

**Don't have a cow!**

Bart's platform leaping is a test of joystick dexterity and timing. And it's here that Bart

That little birdy will tell you a tale if you can encourage it off the statue.

Skate city and a change of pace follows but watch out for the surf dude!



**The Simpsons Ocean ■ £25.99**

- Looks and feels like a console game: a good console game.
- Intro captures the flavour of the Simpsons well.
- Small sprites and garish colours are a tad hard on the eyes.
- Infuriatingly good timing and platform puzzles.
- A highly playable game that uses its licence well.

**Verdict 82%**

AMIGA VERDICT

When was the last time you can remember playing a totally mad-thrash shoot-em-up? These days game companies tend to concentrate on graphics presentation, whereas in the 'old days' video games consisted of simple, brightly-coloured sprites and overpowering sound but with gameplay that left you breathless.

Jeff Minter has long-professed his admiration of early 80s coin-ops, particularly Williams games such as *Defender* and *Robotron 2084*, and was the man responsible for the Amiga version of *Defender II*. Minter thought that it was a crime that there wasn't a version of *Robotron* available on home computers so he put his talents to the task of producing his own interpretation.

### Furry monsters and laser creeps

You take control of a laser-spitting llama (yes, a llama) who travels through a series of 100 zones attempting to rescue innocent stranded creatures from alien mutants. In order to rescue the camels, goats, llamas and sheep the

**Sorry! There's no time for a toilet break, you've still got a whole hoard of Zyaxxian mutant invaders to blow away and a herd of friendly beasts to rescue before the level's over. Don't be tempted by those cool, refreshing cola drinks either. They're really deadly alien invaders trying to infiltrate our 20th century lifestyle, so I wouldn't trust them if I were you.**

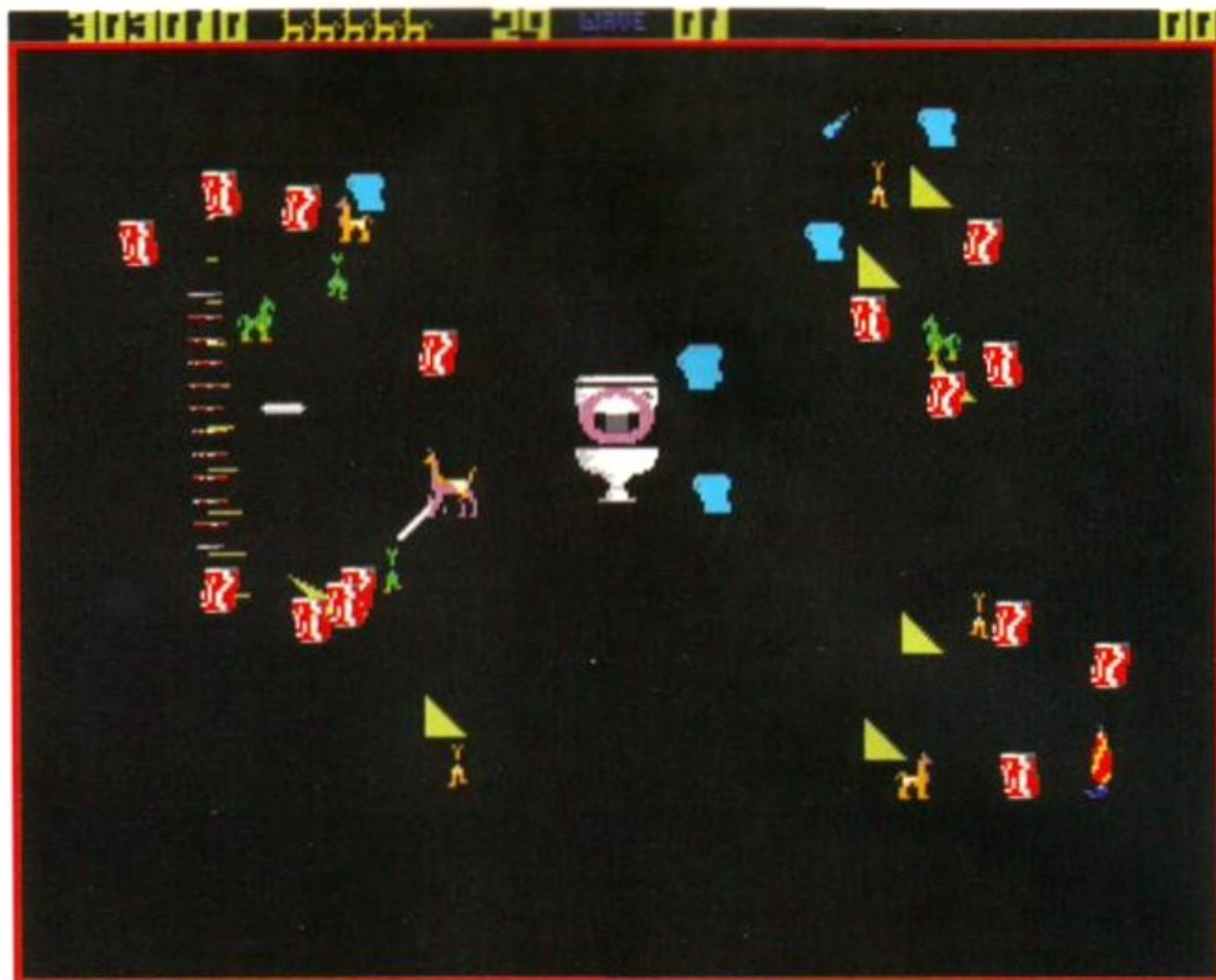

# Llamatron 2112

heroic animal must walk around the screen picking up the creatures while fending off attacks from the aliens.

To help you kill the enemies, is a directable laser-weapon, which can be locked in one direction by holding down fire. This allows you to attack in one direction.

**Oh no! Heavy! Hang around too long under that 16 ton weight and your llama will soon be nursing a rather severe headache.**



Once you've managed to clear all the mutants from a screen, you can usually progress to the next and if you collect all of the lovely creatures before you finish, you get a bonus score! However, some waves are classed as 'Herd Waves', which require you to collect all the friendly creatures before you can finish the level.

*Format* staff, with much joystick-wrenching and swearing to be witnessed. Even though the game is pretty old fashioned with its frantic sound effects and simplistic graphics, it packs a hell of a punch in the gameplay department. The game is very easy to get into due to its simple nature, but it's very difficult to put the joystick down once you've started, so be prepared for some long nights of game playing!

There are a few quirks, such as the odd glitch in the sound and graphics every now and then and the fact that the collision detection tends to go rather awry from time to time, but even this doesn't detract from the highly enjoyable and furiously addictive gameplay.

Since the game is shareware, the only asking price is a plea from Jeff to send him a fiver for his efforts, this game shouldn't be missed. So get those fivers out!

Maff Evans

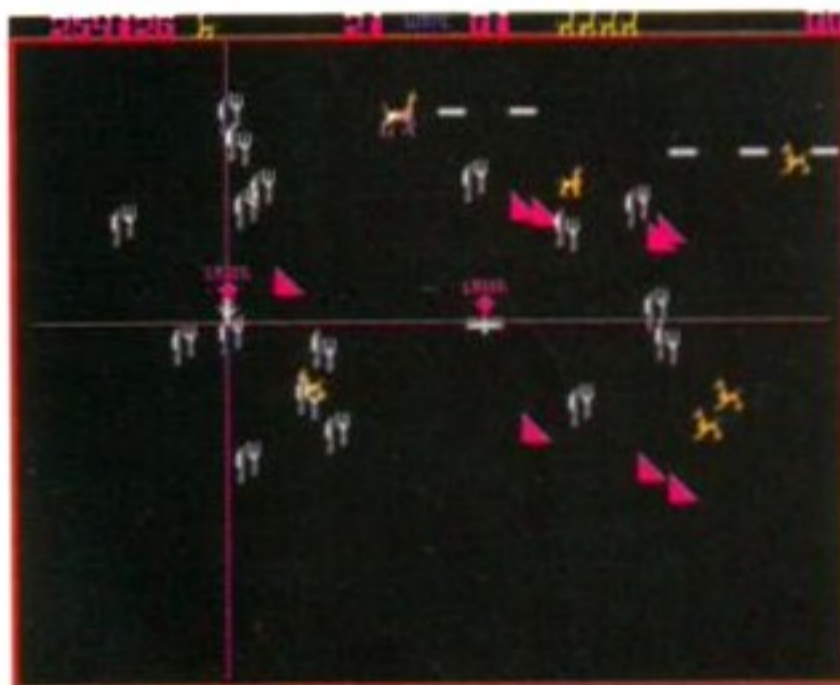

**As if the marauding aliens weren't enough, they've started sticking lasers into the affray. Hardly fair! Still that's furry interstellar war!**

### All that Glisters helps your Quest

You can get an edge over the alien mutants by picking up the icons that they occasionally drop. These give you extra tools and weapons to help defeat the foe.



**3-WAY SPLIT** - Gives you a spread three laser streams.

**INVINCIBILITY** - Makes you immune to enemy attack for a limited time.



**HOT BULLETS** - Fires a faster stream of more deadly shots.

**FLOYD BONUS** - A bonus is added to your score.



**BOUNCE SHOTS** - Allows you to ricochet shots off the walls.

**SMART TOMATO** - Zaps everything on the screen.



**EXTRA LLAMA** - Adds a life to your supply.

**LOVE HEART** - Makes the creatures fall in love with you and rush towards you.



**WARP** - Adds 50,000 to your score and moves you on five levels.

### Free for all

Not since *PGA Tour Golf* has a game managed to grab the attention of the entire *Amiga*

### SHARE AND ENJOY

*Llamatron* occupies a strange position in that it isn't a commercially available game. It's essentially a public domain program, so once you've got hold of it you can distribute it freely among your friends. However, if you have a copy of the game and enjoy playing it, you are obliged to send £5 to Jeff Minter for his trouble. It's a good idea to be honest and shell out the dosh (after all, look at the quality of the game for the price) since good programmers deserve to get something for all their hard work. It may even induce other writers to come up with great games under the Shareware scheme.

### LLAMATRON 2112 Llamasoft ■ £5

- Simple graphics with incredibly bright colours and highly-intense strobe-lighting.
- Wild sound packed with odd samples and excellent echo effects.
- The simple gameplay is fast and massively addictive.
- An old style game which is superb value (if you're honest).



Verdict 89%

# R-TYPE

## III

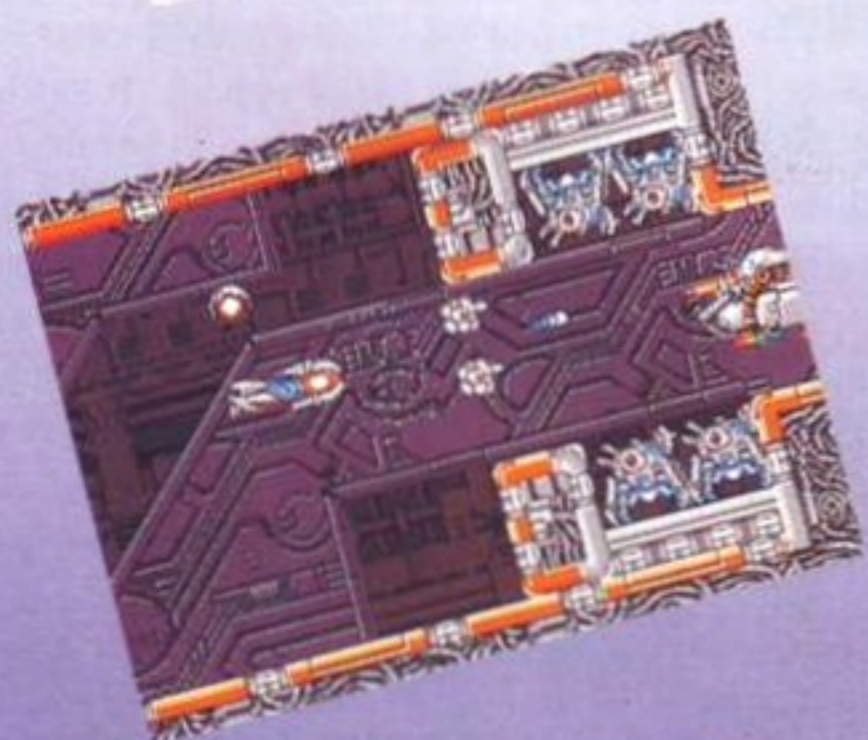
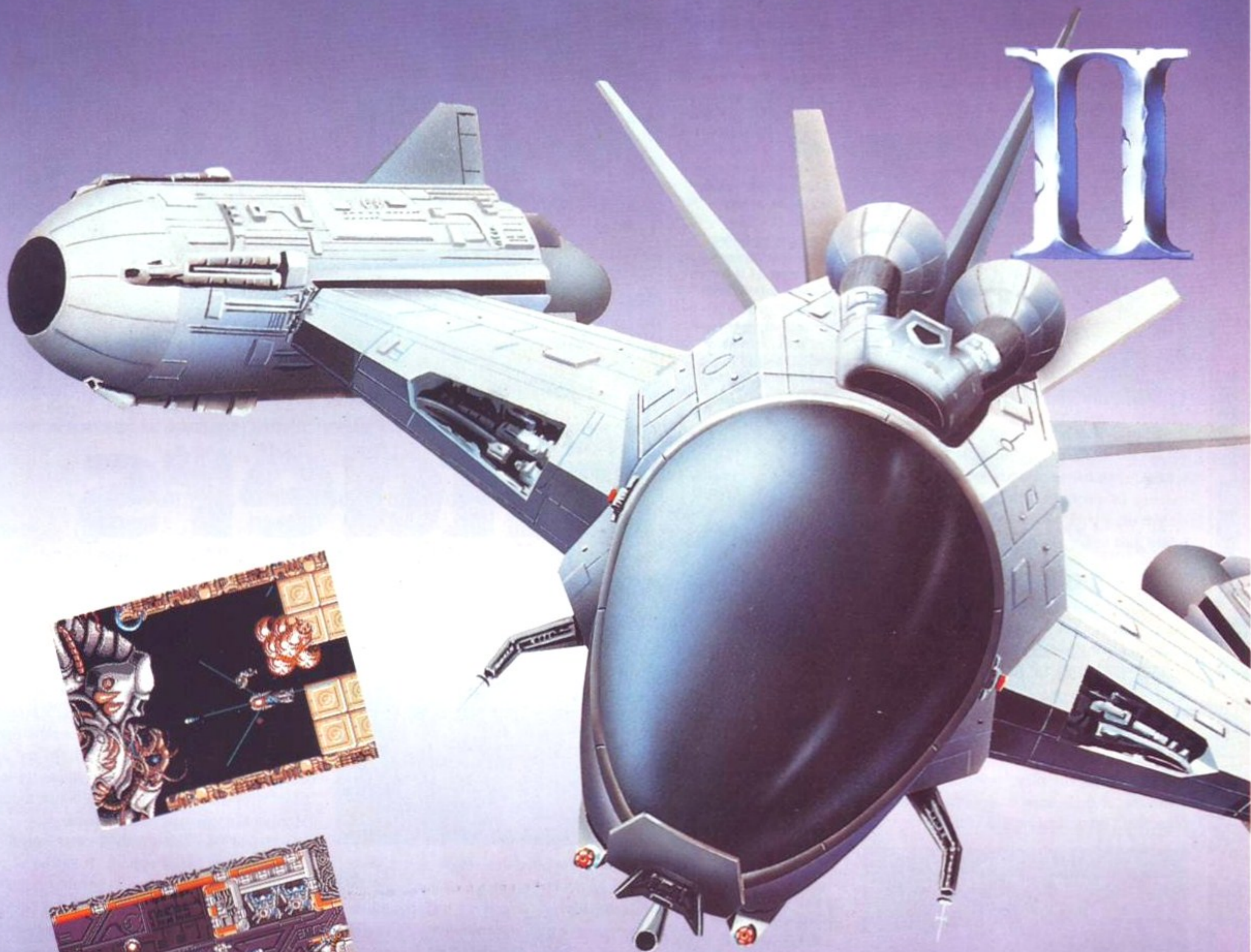

**THE FIRST WAVE WAS EASY.  
THE SECOND WILL DROWN YOU.**

Emergency News Bulletin 07.63.... Attention all Starfighter pilots....The evil Bydo Empire is out for revenge.... Stronger, faster and more dangerous than before....the attack waves have started....a remodeled "R-9" Starfighter is armed and ready for you....proceed to the battlefield immediately....the nightmare has returned....

Available in September  
on ST & Amiga formats.

**ACTIVISION**

**B**alls have always held a strange fascination for computer-gaming folk. This game has all the traditional trappings of spheroid spectaculars, combined in a two-player sports special. Balls, as they say, have been done though; so can this one offer enough new features and playability to offset the loss of novelty?

The game is, the retroactive school of game justification argue, a future sport, played by humans cybernetically, directly in to some

**The yellow square in the top left is the opposition's goal. You have to drag the ball across it to score. You have to coax the ball to move your way. It's easy when the other guy isn't around but when you're scrapping for possession...**

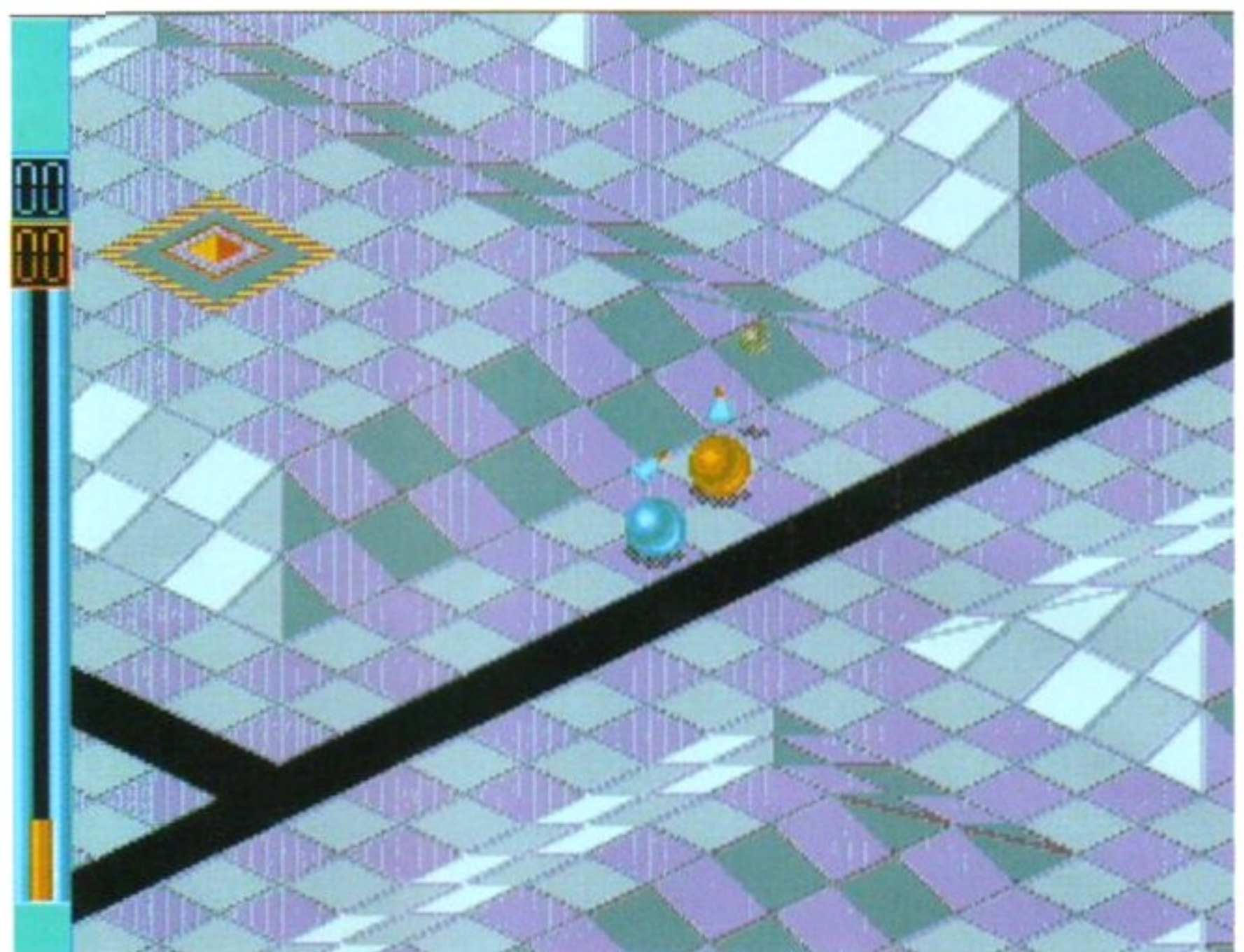

**In two player mode you share a split screen. It's fine when viewed like this but when you are going at it head to head you'll need good sea legs. Screens are going this way then that and ... excuse me I think I'm going to be ill!**

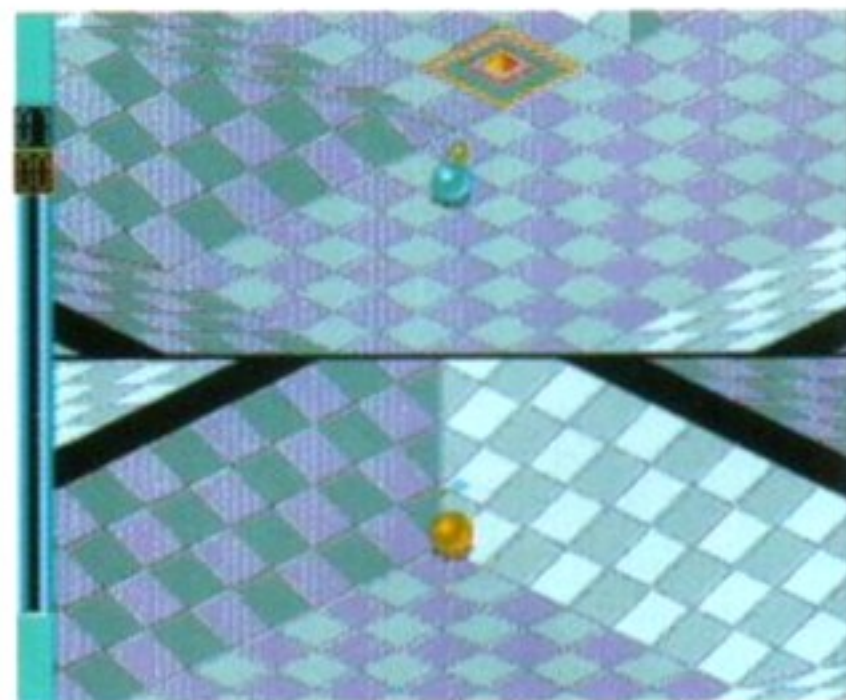

megalithic ether net. In reality it's a ball game of attraction. You control a large coloured sphere, that roams a rectangular grid. Also making its presence felt is your opponent's sphere of, a puck and a few terrain-based surprises, just to keep things rolling along.

**Use the force**

The aim is to magnetically drag or shoot a puck across your opponent's goal area. Controlling the magnetic force with the fire-button, you simply have to shepherd the puck to the small coloured square that the other sphere started in. After you have scored a goal you're whisked back to your end and the whole show starts again.

It's simple to play: joystick commands following logical lines and with an obvious objective. What makes life difficult are the

**The targets are trampolines. Hit one of these and you're thrown into the air. This is annoying on a high gravity situation, but if you've tweaked the play-field set up then it can send Sliders sailing off into space. The trampolines are particularly nasty here as the puck is affected too.**

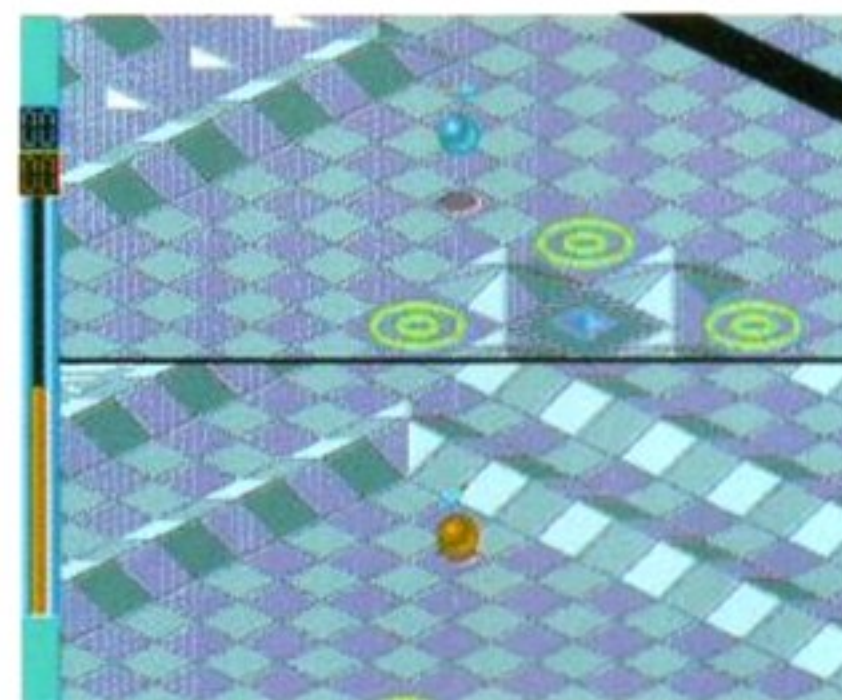

may even be applied to a single player, giving them a particular advantage or handicap. And while initially amusing, it is a little pointless.

**Get personal**

All sport games are best in two-player mode, as beating a human opponent is far more satisfying than whupping a computer-generated one, and this is a particularly good ball game against friends because it requires both skill and luck to be in the lead when time kicks itself out. Two players jostling, running and shooting is *Sliders* at its best. When you just

**The options screen allows you to set up the game with any combination of different factors. Some make the game faster, so are just funny. It's possible to even set one player's parameters differently to the other's. While highly effective it does smack of foul play!**

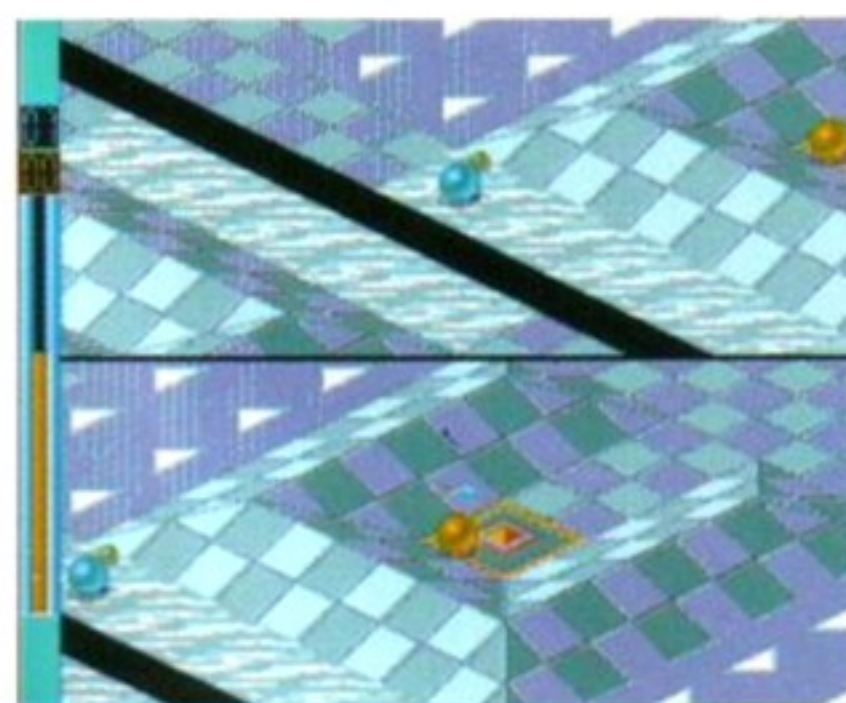

**Slippery when cold. The ice sends the spheres skidding around uncontrollably. When combined with the ramp around the goal the ice is a real points killer.**

manifold ways each of the 12 pitches are set up. Some are littered with ice that robs spheres of control, one-way tiles that force balls in specific directions and slopes that sap speed. The tougher, later pitches even have trampolines to send pucks and players sailing into the air, often way over the goal.

The way each pitch, player and puck will behave are offered as options before the game is played. Everything from ball speed to gravity can be affected, which makes it a useful utility for first time *Sliders*. These modifiers

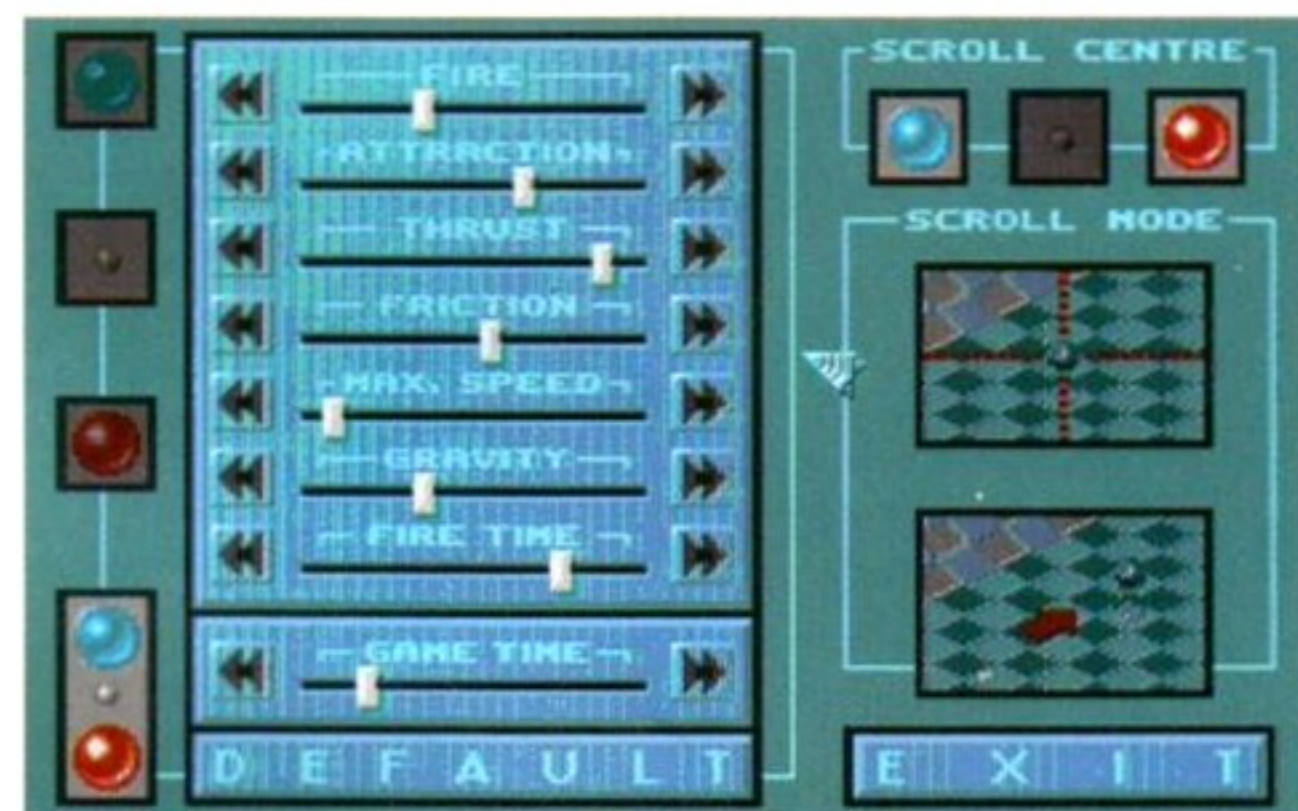

# Sliders

play in the one-player mode, though, there is something that is sadly lacking. There's no personified opponent and victory feels strangely hollow.

There is graphic style but no real glory. The screens scroll smoothly, slopes and special tiles are easily visible, but there's nothing breathtaking or even inspired. *Sliders* is functional, but not flashy, doing little to try and draw you in. Even goal's are only faintly lavished with sound effects, which is just a quiet Marilyn Munroe-type sound sample.

*Sliders* doesn't really offer enough, despite a huge list of options. It has no visual magic and only 12 different playing fields to explore. Played by two people it becomes a frantic race for puck control, a race only interrupted by insane geography. Play it alone and the interest quickly flags.

**Trenton Webb**

**Sliders Palace ■ £25.99**

- A wealth of options to affect play.
- Lacks the necessary definition to pull players in.
- The graphics work well but lack any personality.
- Only 12 different zones to play in.
- Seriously improves when played against human opposition.





# Micromail

Unit 9, Smug Oak Business Centre  
Lye Lane, Bricket Wood, St Albans, AL2 3UG  
Tel: (0923) 894111 - 8 Lines  
Fax: (0923) 894143

**DEAL OF THE MONTH**  
Star XB24-10  
Pro Quality 24 Pin Colour  
1 Year Free Onsite Maintenance  
**£335 inc VAT**

## AMIGA 500 "CLASSICS" GAMES PACK

Includes: 1Mb memory "The Simpsons", "Captain Planet and the Planetears" and "Lemmings" games, plus Deluxe Paint III, plus Quickshot Joy Stick.  
**£389 inc VAT**

## AMIGA 500 GRAND PACK FULL SCREEN GEMS PLUS:

10 Hit Games, 20 PD Power Pack, Word Processor, Spread Sheet, Date Base, Accounts, Virus Killer, Games, Demos, 10 Blank Disks, 80 Capacity Data File Disk Box, Dust Cover, Mouse Mat, Python Digital Joystick  
512K Amiga **£369 inc VAT**  
1 MB Amiga **£389 inc VAT**

## AMIGA 500 SCREEN GEMS

Includes full Amiga Pack plus  
• Shadow of the Beast II  
• Days of Thunder  
• Back to the Future  
• Night Breed  
• Deluxe Paint II  
• Virus Killer Disk  
512k Amiga **£329 inc VAT**  
1 MB Amiga **£349 inc VAT**

## BASIC AMIGA 500 TO GET YOU STARTED INCLUDES:

Mouse, PSU, 512K RAM, 1 MB Disk Drive, 4096 Colours, 20 PD Disk Power Pack includes: Word Processor, Spread Sheet, Data Base, Virus Killer, Demo Games, TV Modulator, Three Manuals, Built in Speech Synthesis, Python Digital Joy Stick, Mouse Mat.  
512K Amiga **£299 inc VAT**  
1MB Amiga **£329 inc VAT**

## CD TV £599 inc VAT

Commodore 1084S Monitor with leads ..... **£219 inc VAT**  
Phillips 8833 Mark II with leads ..... **£229 inc VAT**  
Zydek External Disk Drive ..... **£55 inc VAT**  
Cumana External Disk Drive ..... **£69 inc VAT**  
A590 Hard Drive ..... **£265 inc VAT**  
KCS 500 Power Board inc 512K exp, MS DOS, Shell, 640K ..... **£325 inc VAT**  
CBM A501 512 RAM Expansion ..... **£215 inc VAT**  
512K RAM Expansion ..... **£39 inc VAT**  
2 Mb RAM Expansion for A590 ..... **£29 inc VAT**  
10 Blank Disks ..... **£69.00 inc VAT**  
50 Blank Disks ..... **£5.99 inc VAT**

## ORDERING

## AMIGA 500 FIRST STEPS

EDUCATION PLUS PACK  
A501 512K RAM Expansion, Lets Spell At Home, Prowrite, WP, Infofile Spreadsheet, Deluxe Paint II, Deluxe Print, Music Mouse, Logo, Talking Turtle, BBC Emulator, 5 BBC Programmes, 10 Blank Disks, Do's and Don'ts Poster, Resource, In Pack Video, NAPE Booklet, Python Digital Joystick, Plus 20 PD Educational Games  
**£469 inc VAT**

## AMIGA 1500

Twin Floppy 1 MB RAM, Mouse, 1084S Monitor with the Work Platinum Database, WP, Spreadsheet, Deluxe Paint III, Simcity, Populous, Their Finest Hour, Battlchess  
**£859 inc VAT**  
with TV Modulator, no Monitor **£649 inc VAT**

## CLASS OF THE 90'S

AMIGA 500 PLUS  
A501 512K RAM Expansion, Midi Interface, Deluxe Paint II, Superbase Personal, Maxiplan 500 Publishers Choice, Dr T's Midi Recording Studio, Logo, BBC Emulator, 5 BBC Programmes, 10 Blank Disk, Mouse Mat, Disk Wallet Quickshot Joystick Plus 20 PD Educational Disk  
**£519 inc VAT**

**ALL AMIGA SOFTWARE 10% OFF R.R.P**

TELESALES NO: (0923) 894111

Government and School Orders Welcome.  
Next day delivery for credit card orders placed before 4.00pm subject to availability. Alternatively send cheque, postal order to Micromail Ltd, Unit 9, Smug Oak Centre, Lye Lane, Bricketwood, St. Albans, AL2 3UG. Please allow 5 working days for cheque clearance. Subject to availability, despatch is normally within 24 hours of receipt of cleared payment.

**DELIVERY CHARGES:** UK Mainland (not Highlands)  
Small consumables & software items Despatched by post, please check charges when ordering  
Other Items except lasers Next day courier service, £10 per box  
Laser printers Next day courier service, £17.50  
Offshore and Highlands Normal rate plus £20 + VAT per box  
In addition we offer the following express services:  
Saturday deliveries Normal rate plus £10 + VAT surcharge per box  
7am - 9am next day Normal rate plus £10 + VAT surcharge per box  
Am next day Normal rate plus £5 + VAT surcharge per box

Prices are subject to change without notice E. & O.E.

## PRINTERS

HP DeskJet 500 309 + VAT  
HP PaintJet 649 + VAT  
HP LaserJet III 679 + VAT  
HP LaserJet III 1059 + VAT  
Canon BJ 10E 229 + VAT  
Citizen Swift 9 Pin Colour with lead 162 + VAT  
Citizen Swift 24 Pin Colour with lead 234 + VAT  
Star LC200 Colour with leads 166 + VAT  
Star LC24 200 Colour with lead 234 + VAT

## AMIGA 4 - 9 yrs BEGINNERS PACK

Amiga 500, Funschool 2 (Specify under 6, 6 - 8 yrs or 8 +) and Funschool 3 (Specify under 5, 5 - 7 yrs or 7 +), Best Educational Games on 10 disks, Quickshot Joystick  
512K Amiga **£359 inc VAT**  
1 MB Amiga **£379 inc VAT**



**WHERE TO FIND US**

**Callers Welcome at our Showroom**

open 9-5.30 Monday - Saturday  
open 10-4 Sunday

**AMPLE FREE PARKING**



**Rook takes Knight!** But not the way you'd expect. The Knight is the Samurai character leaping into the air to dodge the Dragon's breath. The Dragon is actually the Rook, which transforms into this mythical beast when administering the coup de grace. However, in Chinese chess, it's always the character on the right which wins. Eat heat and fry, Shogun!

have more restrictive movement patterns and the knights can no longer jump, this is left to the cannons. Well, they don't actually jump, they just lob cannon balls over the heads of other pieces to move around the board.

All in all, the game is more ruthless and barbaric than chess. Pieces are traded a lot earlier and because there are fewer pieces the whole game is generally quicker to play. It's difficult to learn the game and cope with the obscured 3D at times, and this is where the 2D window really comes into its own. There's even a selectable help mode which highlights all the legal and illegal moves that pieces can make, to really spell it out if you're unsure.

### Slow boat to China

The animations are similar in style to those in *Battle Chess*, and sadly, they suffer the same drawbacks too. Disk-loading is triggered every

# Battle Chess II

## - Chinese Chess



Although he looks like a stereotype yokel in a silly hat, the minister is in fact one of the king's staunchest defenders. Pity he can't walk in a straight line though!



The minister cops it full in the face from one of the cannon balls launched by the opposition. Strangely, these ministerial chappies turn into elephants during their demise.

Roughly two years ago, Electronic Arts thought it would be a nice idea to add some new spice to one of the oldest games in the world: chess. This they did in the form of *Battle Chess*, an animated action-version of the old masters' fave. Now they have turned their attention to a little-known variant of the game: Chinese chess, and revitalised this too.

This version features many of the qualities that made *Battle Chess* such good fun: there's the ubiquitous modem/serial link, for playing head-to-head games long distance; you can load and save games at any stage in their development; there are nine different ability levels, giving scope for newcomers and grand masters alike and, of course, there are the detailed death sequences, which is the game's main attraction.

Several new features have been added, just to show that EA aren't slacking. For instance, there are no less than four versions of the board, a 3D, two 2D and a 2D window on the main 3D screen. By using these it's a lot easier to clarify where pieces are located, because the 3D board has a habit of obscuring your view. Music has been added, with a tune

for each piece. These are quite cute at first, as their Chinese-style koto sounds are atmospheric and appealing. However, the smaller number of pieces means you get to hear them more often than is healthy. A tad repetitive, once the initial buzz has worn off.

### Samurai strategy

The game of Chinese chess itself has been well-implemented, and follows the rules exactly (as you'd expect). It's a good deal different from chess, and unless you know how to play it you're going to be spending the first 10 or so games just getting your head around it. Kings cannot move more than two spaces from their start-point; queens and bishops are replaced by counsellors and ministers which



Chinese Chess features more varied screen layouts than its older stablemate *Battle Chess*. The picture-in-picture display shows the board from above, thus clarifying the position of the pieces. It's still a bit confusing if you're unsure what the letters represent.

time a piece is taken, because the animation has to be loaded into RAM. This is a real pain for floppy-drive owners, but hard-drive users can install the game to speed this aspect up dramatically. The animations themselves are attractive and often highly amusing. Each piece has its own attack and defence sequence against each other piece. Obviously, there are a finite number of possibilities, but only the most frequent ones become boring.

Neil Jackson

### Battle Chess II Interplay ■ £25.99

- Good fun, but a bit derivative.
- Too diverse to be mainstream.
- Too clumsy and slow for beginners
- Loads of different viewpoints to show where everything is
- Fantastic if you know the game and have a hard drive.

Verdict **76%**

While not as detailed in strategy as normal chess, Chinese Chess is still no easy game. You can actually take pieces on the first move, but doing so puts you at an immediate disadvantage. Confused? You will be.

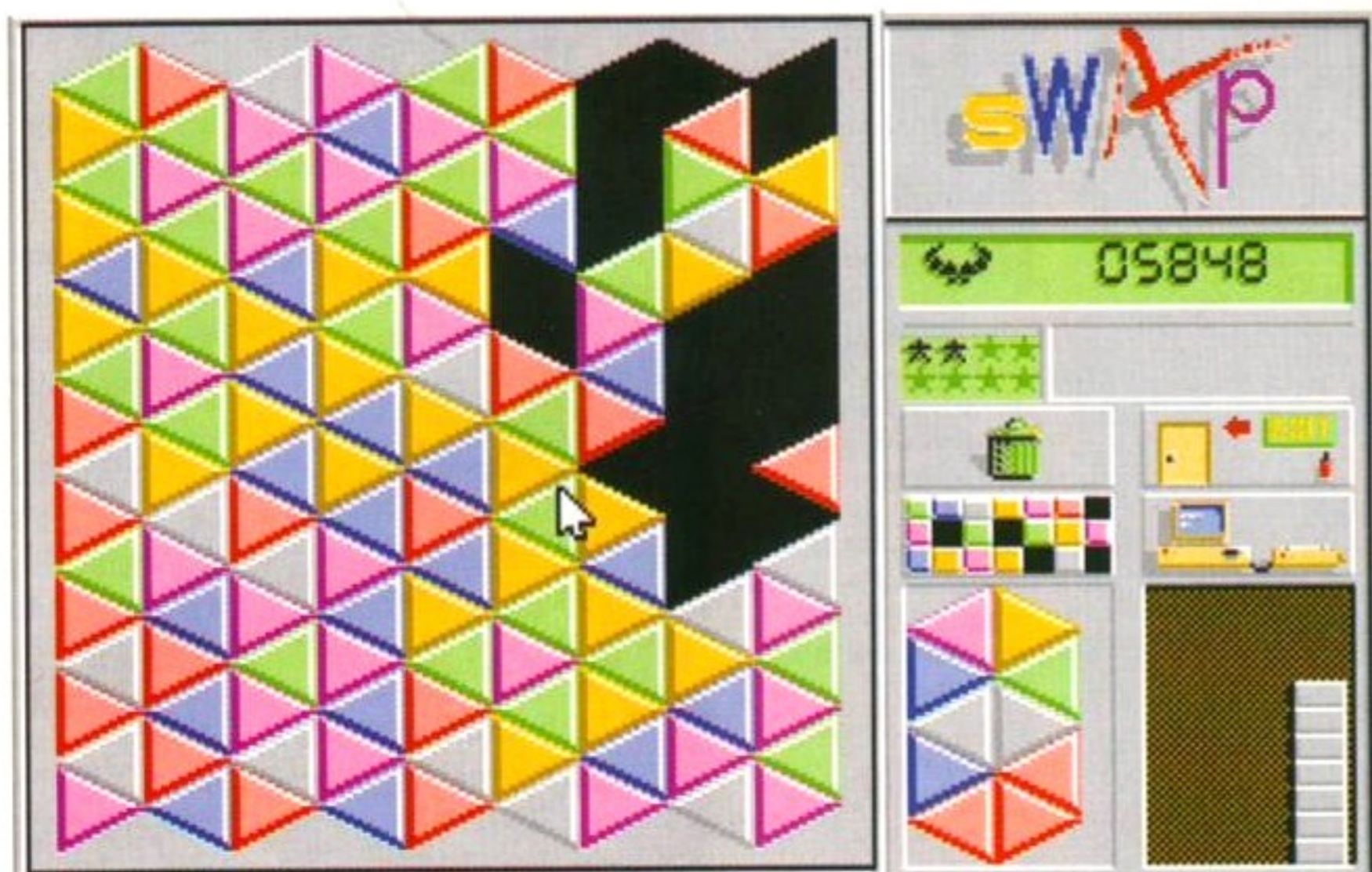

Clicking on the edge of any triangle causes the shape the flip position with the piece it shares that border with. If this brings two similar colours into contact they disappear leaving a hole on the board. Swapping costs points if no match results, so for the first few moves of any level your hands are tactically tied.



These big squares are the easiest shapes to swap, because the results that they produce can be mentally predicted, unlike hexagons or triangles.

AMIGA FORMAT

# Swap

Puzzle games come and puzzle games go, but few make a real mark. The successful few have all combined pressure, mental agility and control dexterity. Rather than stressing speed, the emphasis is on intensive forward planning, to make players sweat out a solution. A brave departure from the normal puzzler format, *Swap* is initially so bewildering to play it's not entirely clear why you should play.

## Multi-coloured swap shop

You are presented with a wall of multi-coloured tiles. The tiles range in shape from triangles to hexagons and come in six different colours. The tiles can be manipulated by clicking on any touching edge, which causes them to swap position, by pivoting around the clicked side. If a swap causes similar colour tiles to touch, they disappear; scoring points and leaving a dirty great hole in the middle of the wall. Clearing a wall ends that level.

Swapping routes have to be calculated, so that similar tiles aren't isolated when its neighbours disappear. This is complicated by the



variety of sizes and shapes. Each one needs specific playing tricks if too many tiles aren't to be left hanging space and unable to swap.

## Avalanche!

*Swap* isn't a fast game: even the timed levels are temporarily generous. It's a cerebral test of thinking ahead, working out which tiles will disappear as a result of any particular swap. You are rarely stranded with unswappable tiles at the end of a level, though, as there are a number of points debiting cheats on offer. An avalanche introduces gravity to the situation, pulling all the remaining tiles to the bottom of the screen and removing any resultant matches. Some spare tiles can even be bought at a direct points cost, to match up lonely solo tiles and make them vanish. Even these cheats aren't limitless and real caution is needed if you want to leap through the levels and clear that wall.

Progress throughout the game isn't sequential: the more efficiently you clear any screen, the more points you earn and the higher the next level you have to face will be. If this isn't to your taste then a level designer is on hand for some self-constructed practice. In fact it is quite curious, fascinating and forgettable. The game doesn't work hard to pull

Hexagons are reasonably simple because they've so many sides. The black stars to the right of the game board show how near you are to finishing the level. When they are all blacked out you can exit and still advance a level.

you in, but does exhibit some delightful touches in design. Its simple concept allows for few real embellishments, but the game's simplicity can prove absorbing.

## To hook or not to hook?

The puzzles are formed by the limited movement and the disappearing nature of the tiles which combine to form this strange puzzler. *Swap* doesn't develop these inherent gameplay strengths, but it doesn't really need to, it merely dishes out more complex permutations with far fewer cheats. The unfortunate side of this is that if it doesn't hook you straight off, it never will.

There are few traditional puzzle-game trappings to be found. It is truly different, not stressing action or time, just thought. This can be considered a failing as the slow pace implies a lack of intensity, but it does not lack depth. It does not even lack intensity, the focus is just on the brain and not swift mouse or sprite control.

The lack of physical interaction with *Swap*, gives it a cool if not cold feel though. There's little excitement while playing, a factor which could be easily balanced with big pay offs elsewhere. Yet, no such pay-offs are to be found and the interest in completing levels wanes. And without player interest *Swap's* longevity is limited.

Trenton Webb

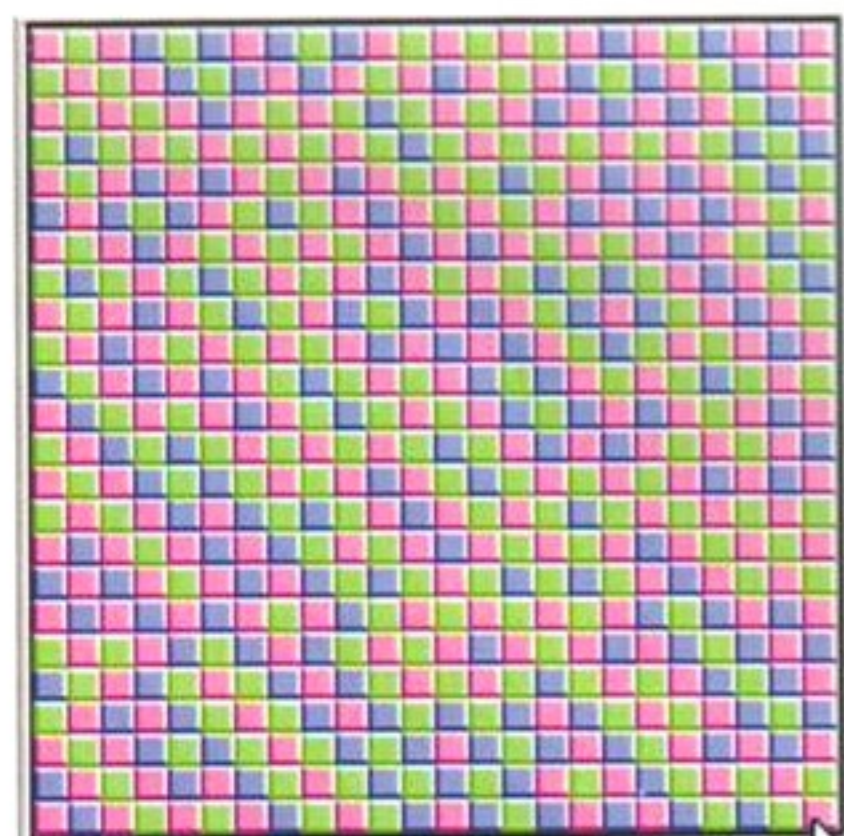

Severe eyestrain time! Small squares are really evil. It's not the shape, it's not even the size, it's the number of the little beggars. Still there are plenty of points up for grabs on this level.

**Swap Palace ■ £25.99**

- Simple but strong puzzle formula.
- Supporting effects are sparse.
- Non-sequential levels allow quick advance for better players.
- Requires forward thinking rather than fast reactions.
- Lacks staying power as there are few 'payoffs'.

**Verdict 59%**



# Quickjoy

Joysticks

EUROPE'S No.1  
SELLING RANGE



£15-95

SV301 NI-5 for Nintendo  
6 Microswitches New Pilot Grip



£6-95

SV122 II PILOT Twin Fire  
Buttons Autofire Suction Cups



£9-95

SV123 Supercharger Twin Fire  
Buttons Autofire Suction Cups



£14-95

SV126 JETFIGHTER 6 Micro-  
switches NEW Pilot Grip Autofire



£17-95

SV125 SUPERBOARD 10 Micro-  
switches Digital Stopwatch Autofire



£29-95

SV203 ANALOGUE JOYSTICK  
with Twin Port Games Card



SV127 - TOP STAR  
6 Microswitches  
Autofire  
£23-95



£4-95

SV119 JUNIOR Twin Fire Buttons  
Suction Cups



£14-95

SV401 SG FIGHTER for SEGA  
6 Microswitches New Pilot Grip



£8-95

SV124 TURBO 6 Microswitches  
Autofire



£17-95

SV201 for IBM PC  
M5 6 Microswitches New Pilot Grip



£19-95

SV305 NI-PRO for Nintendo Six Fire  
Buttons Autofire with Speed Control  
Six LED Lights for positive response



£24-95

SV128 MEGABOARD 8 Microswitches  
Stopwatch & Countdown Timer Autofire

*For Ultimate Action & Performance*

Now available from Selected Branches of...



WH SMITH

John Menzies

BOOTS



Selfridges



Software PLUS

□ ▽ = available from

... and all good computer dealers.



SPECTRAVIDEO, UNIT 27 NORTHFIELD INDUSTRIAL ESTATE, BERESFORD AVENUE, WEMBLEY, HA0 1NU, ENGLAND

TELEPHONE: 081 900 0024 • FACSIMILE: 081 903 6625

# THE FIRST BATTLE YOU WIN IS AGAINST YOURSELF

It's your first day on the assault course.

You're cold, wet and knackered.

Ahead of you is a wall that looks about ten feet too high.

And some joker in uniform is yelling at you to get your rear end into gear and get over it.

Not surprisingly, it's at this point that many recruits begin to have a few doubts as to the wisdom of a career in the Army.

(Not to mention the capacity of their muscles to take more punishment.)

But if you don't walk away now, you'll have won your first victory.

That's why we push you hard to begin with.

To get you fitter than you've ever been.

And to find out if you can take the pressure.

Because the Army can't afford to have people who walk away when the going gets tough.

Thankfully, it won't be too long before you begin to change for the better.

As well as gaining muscle, you'll also gain in confidence.

The rifle that felt so odd at first now feels familiar.

The strangers you trained with are now your mates.

You stop getting lost on night exercises.

Finally there is a big breakthrough: your instructor smiles.

One day, you realise you have begun to think and feel and act like a soldier.

You can allow yourself a pat

**THE ARMY.**  
**YOU CAN MAKE IT.**

The Army, Freepost 4335, Dept. 5461, Bristol BS1 3YX.

Mr/Mrs/Miss/Ms (PLEASE PRINT.)

Address

Postcode

Telephone

Age

The Regular Army is an equal opportunities employer and welcomes applications from ethnic minorities.

on the back, because you've made it.

But there won't be much time to rest on your laurels, because you'll soon be meeting new challenges.

Learning a trade perhaps.

Or getting a posting overseas.

Gaining some valuable qualifications. Or simply perfecting your chosen sport.

We wouldn't like you to think the Army's a picnic.

But it's a lot more exciting than most careers.

If you think you could make it, and you're aged 17-24, we'd like to hear from you.

(You can even join the Junior Army at 16.)

Call in at your local Army Careers office, fill in the coupon, or phone 0345 300 1111, quoting dept. 5461.

You'll find there's really only one obstacle to making the most of yourself.

You.



Core Design are famous for their 3D masterpiece *Corporation* and so this is a bit of a departure for them in that it's a vertically-scrolling shoot-em-up and it's a fairly brainless one at that. The story is a little convoluted: apparently Earth is knackered and the inhabitants are on the move.

Loonies from the planet Mozone have been attacking Earth for over 200 years and the Earthlings are just about sick of it. So you,



**Weird jellyfish monsters from the planet Zob. Use your Freem propulsion blaster to eradicate their kind. The jungle-like terrain makes spotting the little critters a bit trickier than it might be.**

whilst languishing in the comfort and security of the Space Cadet lounge, have been called upon to save Earth from the alien filth. Your bosses feel a bit sorry for you and have decided to kit you out with a massive great gunship. With it, you must clear a path to a safe planet, destroying any aliens which get in your way.

### Get yerself tooled up fer a rumble

Luckily, as the screen scrolls upwards, butterfinger space monsters drop extremely powerful weapons when you shoot them.



These can be picked up and bolted onto your craft. The weapons include spreading lasers, meaty cannons and homing-missiles. Some of these weapons, such as the side-firing electro phaser, tag along behind you like drones as you move around. They usually return to the centre of your craft when you stop, but a neat power-up causes them to trail permanently.

You can collect speed-up pods (just as well because you start off very slowly) and if you collect too many, you can pick up slow-down pods to counter the effect. Sadly, if you lose one of your lives, you lose all the weapons you have collected.

The game features the usual end-of-level bad geezers, very big and requiring huge amounts of fire-power to destroy. There are



**This whirling, swirling alien space fiend pops up a little more frequently than you might expect. Blow up his head section to reveal a lovely little extra weapon. The animation of this beastie is fluid and quick... possibly a little too quick. Some fast reactions are called for to kill this baddie.**

# Frenetic

Mankind is making yet another last stand in the latest vertically-scrolling shoot-em-up. *Frenetic* may be frantic, but is it fun or simply forgettable?

**Arid desert landscape flows smoothly below you. This seemingly lifeless environment is actually teeming with nasty alien sprites and should be approached with extreme caution. The glowing aura around your ship is a shield pick-up.**

**Now on the second level and the planet is coming alive around you. Startlingly fast alien sprites zoom toward you at breakneck speed. Lots of extra weapons are required if you want to progress.**





This is an end-of-level baddie. There are eight of these and this is the smallest and weediest one. It may look big, hard and clever, but it's very easy to dodge. Problem is, the damn thing takes squillions of shots to destroy and you could die of boredom before you actually kill it.



More jungly madness as you swoop low over the planet. The scrolling tends to get a bit juddery when lots of things are all over the screen at once, it doesn't seem to ever slow down. Spooky!

eight levels in all, featuring differing terrain, getting more and more alien the further you get. The attack waves are tricky and often frustrating, but there are no real surprises.

### Two bloke action!

One neat feature is the two-player mode. You play as a team, doubling the amount of fire-power available, but the competition to collect weapons and bonuses is intense. It does become a little easier in two-player mode, but is more fun just the same.

The end-of-level baddies are fairly easy, they take far too long to kill, though, and they're kind of dull. The graphics on the other hand are actually quite nice. The backgrounds are well drawn and fairly effective. They don't



Things are getting a bit frantic at this point. Far too many baddies are trying to kill you and the only way out is to collect some addons and kill, kill, kill!

really jump out and grab you, though, and some of them have been strongly influenced by the game's peers in the genre.

### But what about the graphics?

The sprites are often attractive, but again never outstanding. The aliens don't vary too much, but they're all well animated and smooth. One problem which surfaces a little too frequently is the slowing-down when lots of things are moving on screen. This is especially noticeable in two-player mode and can get quite dreadful.

The scrolling is a little jerky, but not to the detriment of the game. Sound is really cool. Heavy guitar soundtrack, backed up by

"Sound is really cool. Heavy guitar soundtrack, backed up by extremely porky sound-effects."

extremely porky sound-effects. Gameplay wise, the game falls into the category of mediocre. It's not dreadful, but it doesn't offer anything you haven't seen before. In fact, this game blags so many ideas from other games, that the main feeling after playing it, is one of déjà vu. By its very nature, *Frenetic* cannot afford to be *too* original, but in the light of competition like *SWIV* and *Battle Squadron*, it falls in a very dark shadow.

Frank O'Connor



### An everyday tale of space folk, shooting and interstellar nasties

*Frenetic* opens with a cinematic-style intro that shows a shadowy human moving mysteriously towards his craft. It sets the scene well for the blast. The Milk Tray figure is supposed to be you, getting ready for battle.

Glorious cinematic openings used to be the domain of *Psygnosis* and the occasional high-profile game. Now everybody is getting in on the act. The net result can only be good news for Amiga game players as visual treats galore are dished out before a game begins.

The problem with this approach used to be that you had to wade through the entire intro every time you croaked, take *Shadow of the Beast* for instance. *Frenetic* sidesteps this by allowing you to boot the game directly from the second disk, while the intro lives on disk one!

Sure, no amount of pretty piccies can save a lame game but they establish atmosphere and really show what the machine can do when it lets rip - and it's useful for impressing your Gran and other folk who think computing is still in the Speccy age.

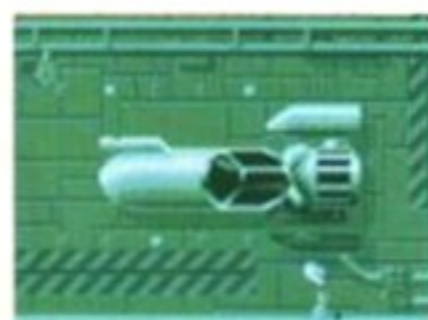

### Frenetic Core Design ■ £25.99

- Lots of levels and things to destroy, but not much to do at the end of the day.
- Graphics suit the game, but no prizes for originality or style.
- Cool music and superb sound effects add some atmosphere.
- A reasonable game, but in a genre full of better shooters.

AMIGA  
Verdict 67%  
FORMAT

# Amiga Repairs

If something is wrong with your Amiga 500 or C64, who better to turn to than The National Repair Centre.

For all repairs to your computer, one low payment covers diagnosis, repair (including parts and labour) and delivery back to you.

The experience and expertise of our technicians ensures that your computer is repaired to a high standard at a low cost. And each repair will be carried out within 12 working days!

To schedule a repair, simply call Michelle or Audrey on 0733 391234.

Please be ready to give your name, address, computer type, serial number and the type of fault.

The cost is £57.45 for an Amiga 500 and £47.45 for a C64. Payment can be made by cheque, postal order or credit card.

**THE  
NATIONAL  
REPAIR CENTRE**

**0733 391234**

FMG House  
Newcombe Way, Orton Southgate  
Peterborough PE2 0SF

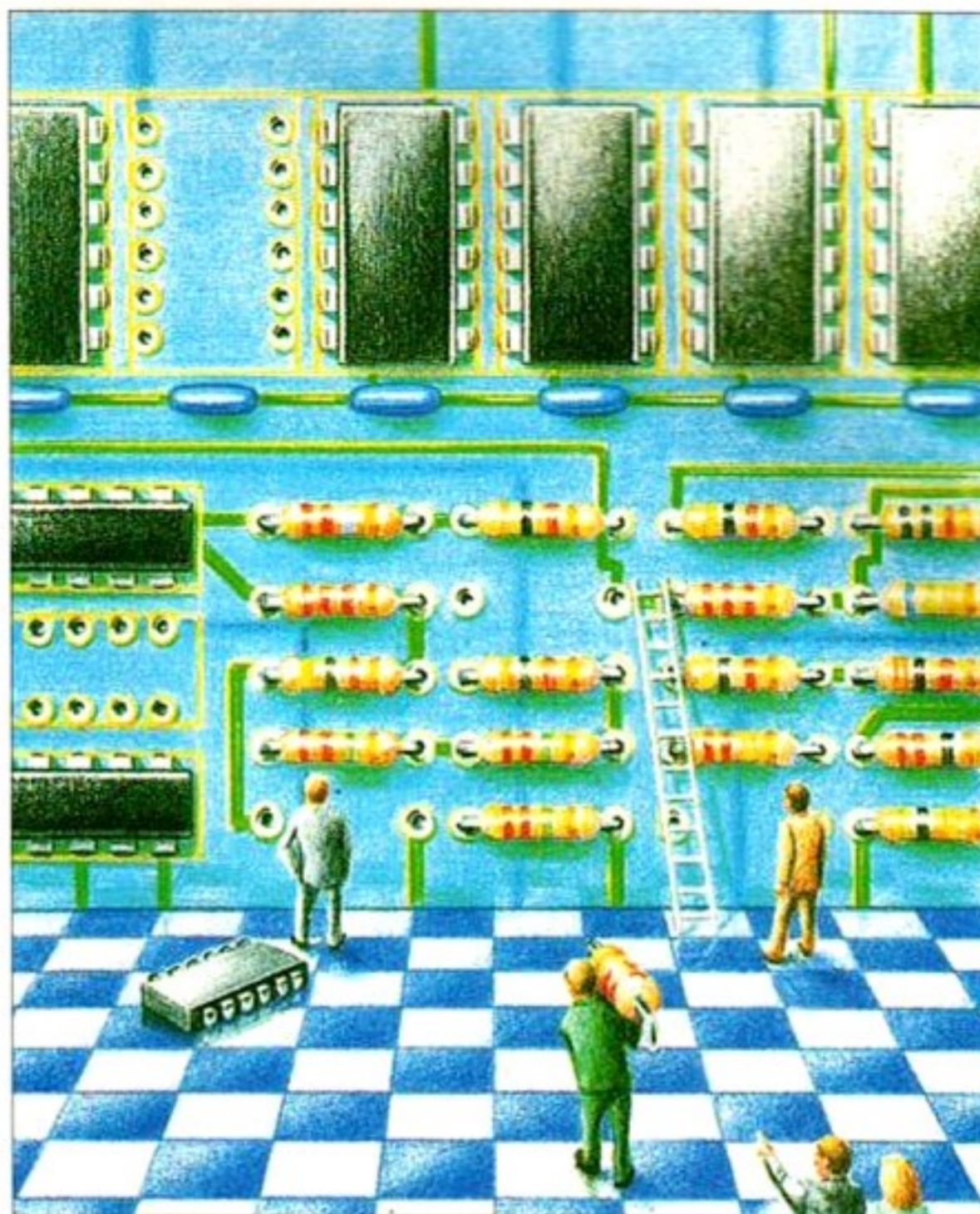

AMIGA REPAIRS



**£57.45  
COVERS  
ANY  
REPAIRS**

The Wall has fallen. Democracy has swept into the East and the World is becoming a far safer place to be in. But behind the public handshakes and smiles the Cold War is still going on. The Bear and the Eagle never sleep.

The USA is still developing its Strategic Defense Initiative (SDI) but the Russians are closing fast. 'Bright Star' is a Soviet laser defence system to rival SDI. It's proceeding apace and only you can stop it. You're in control of the SDI project, which encompasses everything from hiring and firing the staff to arranging for enemy scientists to be 'liquidated'. It's not an easy job.

**Star wars**

The majority of the game is mouse or joystick run and you control everything from a main menu. Sub-menus take you to the detail and the whole thing works smoothly, simply and well. It needs to because it runs in real time and you'll have to make some quick decisions about where to place your spies, assigning people to top jobs and conducting naughty espionage in the USSR.

Bar graphs display everything from team efficiencies to the danger your operatives in the field are in. Slowly, as you manage your people, the SDI project comes together and (hopefully) Bright Star runs into big US-initiated hassle. The knowledge of your team increases as you test all the latest devices. You must determine how well the devices worked and what changes need implementing. Then you get some bods in to carry the changes out, chew the asses of those who've failed and keep the project rolling. This is simultaneous plate-spinning and juggling territory.

Dealing with the FBI and CIA spooks requires a deft touch. They jump at shadows and just love to open fire. But their intelligence is vital if you're to trip up the Russians. They also look after your own security. Leaks cost lives, and worse, make the President look bad in front of the cameras.

You can talk to the Russians, and even negotiate with them (the flesh creeps...), but the game really hinges on how you play your two trump cards. One is the Archer. This is an elite Afghani rebel who is fighting for his homeland (which he's since had back, incidentally). "Bright Star" is close to the Afghani border, so a stray missile might perhaps be

Choose your department heads carefully. Logically this would mean avoiding people with dark glasses, strange hair and foreign names, but since that rules out 90 per cent of the USA's scientific community, you'll have to have some pinko weird-beards in. Just keep a close watch on them, that's all.

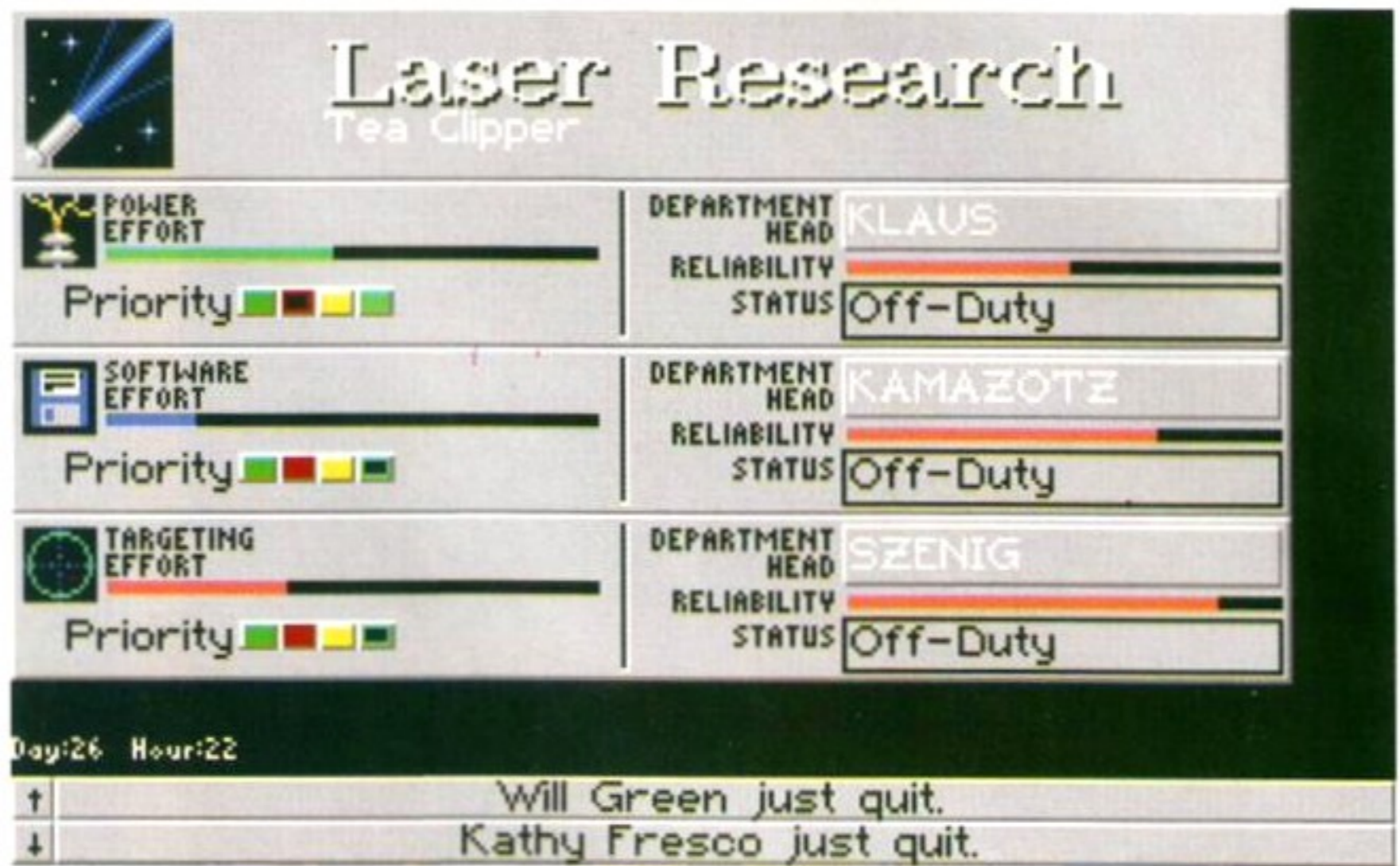

# Cardinal of the Kremlin



launched. You actually get to do this in a little arcade sub-section fought on a map of Afghanistan. You control Archer's troops with the keyboard (mouse or joystick strangely aren't allowed). When he moves close enough to the Bright Star complex you simply hit the attack key and he should do the rest.

**The Empire strikes back**

Then there's the central character: The Cardinal. He's a Red Army Colonel but luckily for you he's also an American spy. Believe what he tells you because it'll be vital to whether you win or lose.

If you want more reconnaissance satellites, then simply commandeer the Shuttle, chuck out all the civilians and get the press out of the area. Bung your satellites in the hatchback and off to the stratosphere you go.



The Cardinal. A deeply religious man, he likes nothing better than golf, social drinking and betraying his country's most important secrets to the inferior Western capitalist war-mongers. But if you ask too much of him he could get caught and be given a severe ticking off from the KGB. It might even limit his chances of promotion in the Red Army.

The game is based on the 1987 Tom Clancy novel of the same name, but the atmosphere Clancy imbues his books with is sadly not repeated here. What we have is possibly the ultimate management sim. The detail (all lifted from the impressively accurate book) goes some way to instilling the feeling of Superpowers on a knife-edge, but it's mainly a case of compromise and learn, until experience tells you what settings to select and who to hire. The arcade sequence doesn't help much because it's restricted by memory and is too simple in presentation.

The Cardinal Of The Kremlin is nicely put together. It's pleasant to use but still complex and taxing. However, the Cold War is being forgotten, and this is one management game that already feels out of date.

James Leach

1. The laser research team. Watch for your egg-heads burning out (due to hard work), and make sure they don't blab about their jobs.

2. The laser testing team. These guys try the lasers out (what on exactly isn't specified) They also write the software (and the odd virus when they're bored).

3. The CIA. The spooks look after your 'overseas interests'. They all wear shades and have large armpit-bulges. So whatever you do never annoy the CIA.



4. The FBI. The FBI look after the security of your project. If there are any leaks or defections then it's the FBI who should get it in the neck. If you can find them, that is.

**Cardinal of the Kremlin Accolade ■ £24.99**

- Clearly written game and manual. It's definitely a slick piece of work.
- Time limit and huge number of variables make it a tough game, and one which can be solved in many different ways.
- Atmosphere of international intrigue and governmental intervention is lacking, especially since it the Cold War has passed us by.
- Arcade sequences are distracting from the main football management-sim style game.





## WHY WE INSIST ON VIEWING OURSELVES



CONCEPT...

Our 24-bit image processing software, *Art Department Professional (ADPro)*, gives you the power to import from video digitizers and color scanners. Or input and save to a wide variety of file formats including PCX™, IFF, GIF™, TIFF\* and TARGA®\*. You can

Some may say our perception is a bit bold. But for Amiga users, it perfectly describes where we fit in the image processing world. Directly in the center ... joining input, processing and output.



SOURCES...

even output to video, film recorders or PostScript® printers. And you can expand input and output capabilities as your needs grow.

*ADPro* also solves many complex imaging problems which have plagued the Amiga artist. Modify dynamic range to adjust color vividness. Create professional backgrounds. Remove unwanted pixels in one simple operation. Make aspect corrections or eliminate jagged edges with powerful scaling and anti-aliasing tools.

\*TIFF and TARGA support are part of the professional conversion pack. Available separately. The following names are trademarked by the indicated companies: Art Department Professional, The Art Department - ASDG, Inc.; Amiga - Commodore-Amiga, Inc.; PCX - ZSoft Corporation; GIF - CompuServe Information Systems; TARGA - Truevision, Inc.; and PostScript - Adobe Systems Corp.





## AS THE CENTER OF THE UNIVERSE.

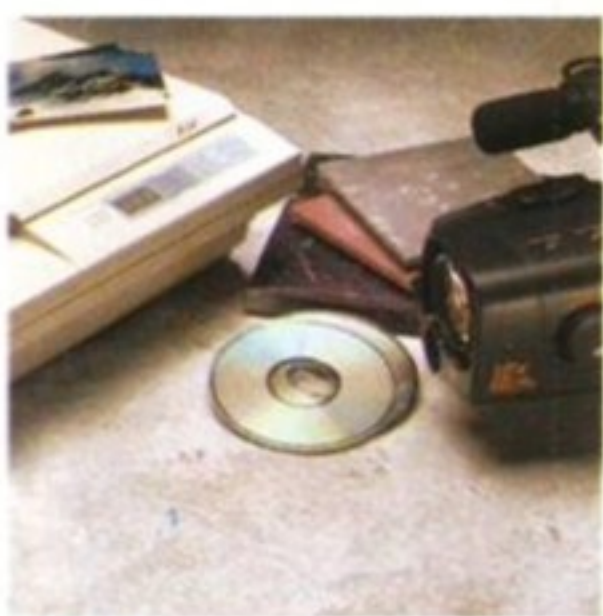

INPUT...

And merge images from different sources (in true color). *ADPro* solves these problems and more with a simple point and click.

It also supports the programming language, ARexx. So you can process hundreds of images automatically or set up your own shortcuts for often-used sequences.



RESULT.

Choose *ADPro* for professional uses. Or for an entry-level alternative, consider *The Art Department (TAD)*. Both place the exciting world of color processing within reach of every Amiga user.

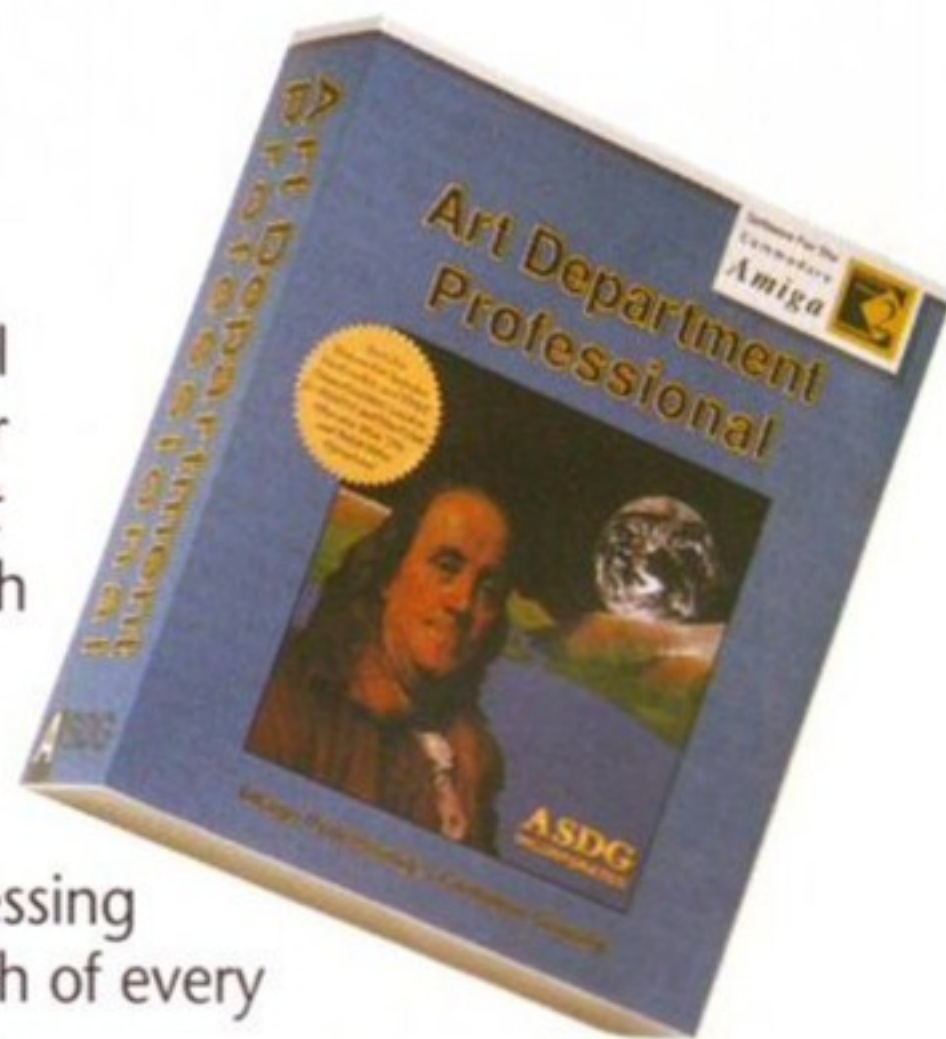

So, join us at the center of the universe. You'll love the view.



“Sir, *Thunderhawk* has been undergoing test flights and the findings are outlined below. The opinion of all test pilots is unanimous, this bird was born to fly. There's one thing all Amiga-based airforces will want to know before procurement takes place though: does it clip the wings of MicroProse's *Apache Gunship*?”



### Rotary club

Once you take a look at the spec, it becomes obvious this is not a real aircraft, but has been built by the programmer (Mac Avery) as a combination of both current design and projected military technology. It's a fictional helicopter that must fly realistic missions in a bid to hold together a fragile peace.

Flying 10 themed missions in six scenarios, the *Thunderhawk* has to live up to its billing as a multi-talented attack chopper. Its roles encompass that of bomber, rescue craft, flying missile platform and submarine killer. Each campaign starts out as a single mission which opens a 10-flight story: a tale you have to see right through to the end.

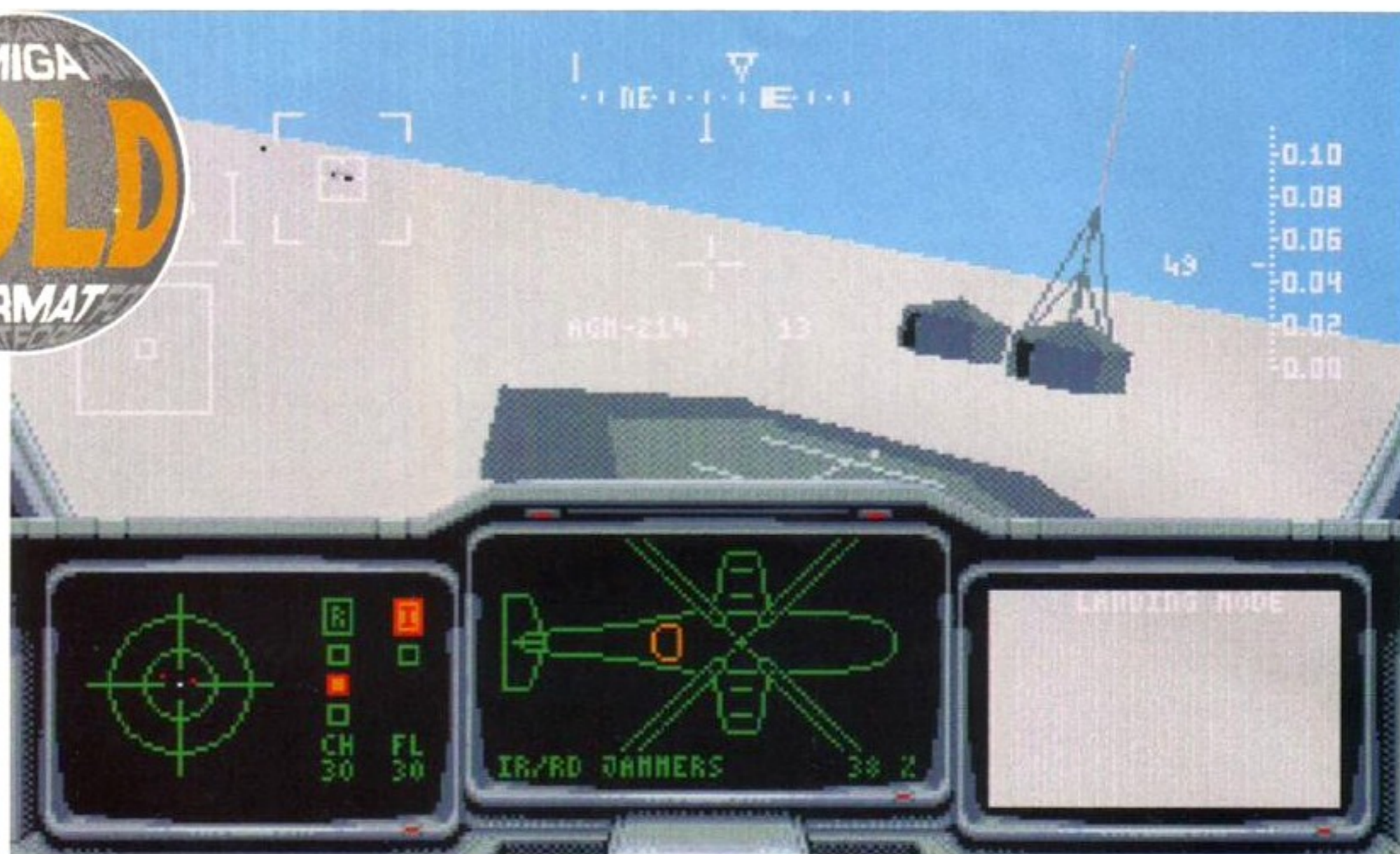

**Thunderhawk edges in for a landing at Ice Station Omega, making *Apocalypse Now* look like *Terms of Endearment*. What will it find? The answer to this mystery will provide the impetus for the next following sorties, so let's hope it's something really violent! Then there will be an excuse to shoot that truck which is locked in your sights.**

# Thunderhawk

AMIGA FORMAT

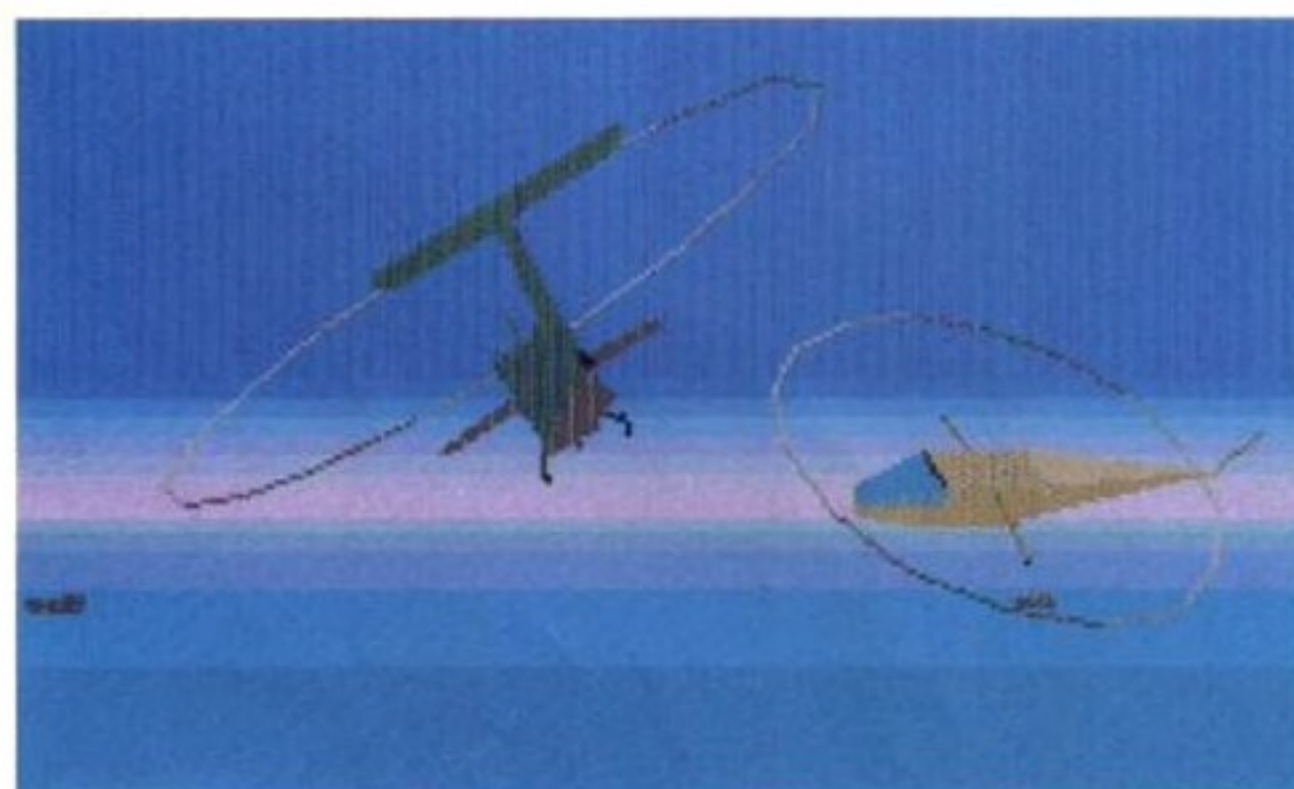

As each mission unfolds the pressure is slowly upped. Raids go deeper into enemy territory, new information alters your objectives and retributive strikes turn simple missions into a hardware hell.

### Collective responsibility

The control system of a chopper defies accurate simulation: the cyclic joystick and collective are two totally separate systems which traditional methods just can't mimic effectively. This is where *Thunderhawk*'s trump card is played. It uses a custom system that pushes chopper sims further than ever before, by uniting all the disparate elements of helicopter control into a single mouse system which adds to the accuracy and playability.

With a crafty combination of button clicks and holds, the helicopter can be flown almost entirely via the mouse. The keyboard commands that remain are for chaff, flares and the 'toggleable' systems, such as night sights. The main guidance comes from the mouse so there's always a free hand available to stab at

the necessary keys when the missiles start to rip. Effective control is never lost as hands transfer from joystick to keypad. Panic, when under fire remains the only problem.

The weapons systems need practice before they can be used effectively, and many *Thunderhawks* will tumble before it's mastered. Competence comes quickly and then the game changes from a futuristic helicopter simulation to a deadly battle for survival. *Thunderhawk* is all about action; a non-stop shooting war where there are only the quick and the dead. Missile batteries have to be blasted or avoided, radars ducked or destroyed, while fighter planes and hunter-killer helicopters of the opposition prowl.

Using the mouse, the *Thunderhawk* soars smoothly with a reassuringly realistic lag between command and response – a factor

good *Thunderhawk* pilots will quickly assimilate and build into their flying technique. Flexible and fast, the mouse system allows a thorough exploration of the helicopter flight experience, which is just as well because the 60 missions test the *Thunderhawk* well outside its performance envelope.

### Slick stuff

Any flight simulation has a limited appeal if the world it inhabits presents no threat or challenge. *Thunderhawk* doesn't suffer here, if anything it overdoses on action. You've hardly time to orientate yourself on the first flight before unpleasant things start hitting the fan. Unpleasant things like anti-aircraft fire and missiles, the fan being your rotor blades.

Slick polygon work and graphic effects ensure that the feel of flight is dramatically

**Close or what! The Thunderhawk and a Hind go at it on outside view. One of the choppers has to die, but which one it is depends very much on the speed of the trigger fingers and the state of the arsenal.**

**Missile madness! Before take off you get to choose which ordnance you'll take out on the killing spree. Just select the weapon you want from the stores and stick it on the hard-point of your choice. Thunderhawk can carry a load of kit, but special tools are needed for special tasks.**





**Look be Hind you!** The only helicopter joke in existence reveals a grim life-and-death struggle. The Thunderhawk overpowers the feared Soviet battle chopper but has to catch it before the killing starts. The hunt is worth it though, the enemy helicopters drop out of the sky with real grace when they're blasted. Just like careless Thunderhawks.

*Thunderhawk* is trying to blast *Gunship* from the Amiga sky and grab the mantle of the top chopper sim. Can a revolutionary control system and 60 sequential missions give it sufficient lift?

retold. Rolling smoothly with every command the world can quickly become a swirling mass of HUD lines and hills if concentration and control is lost. Yet even when the deadly yellow triple-A fire pierces the night sky, and you're using the night-sight, everything remains clear. The HUD and computer-control screens relay flight information calmly, readable at a glance, just the way they should.

The polygons used to create the actual world over which *Thunderhawk* hovers are solidly constructed and move well. Mountains and vehicles are nothing new, but the effects are. Explosions are a swirling sphere of stippled red and yellow spots, that fade to grey when the fire burns out. A small effect but it adds vastly to the realism of the situation.

The atmosphere of the simulation is usually supplied by the craft it copies, but



**Look be Hind - oh that one's been done!** The major gives you a briefing before the mission. He can speak English, the NOE refers to Nap Of the Earth flying to avoid radar. Along with the talk they also show pilots film of the projected target. They're black-and-whites with no sound! You'd have thought that with all the money the Military have, they could at least afford a decent projector!

And night became day! Using the Nightsight may take away some of the colour, but it means you can fight at night. Here the Thunderhawk has just taken on a MIG 29 and won! These are tough to take out and call for some swift auto-rotation in order to lock them up.

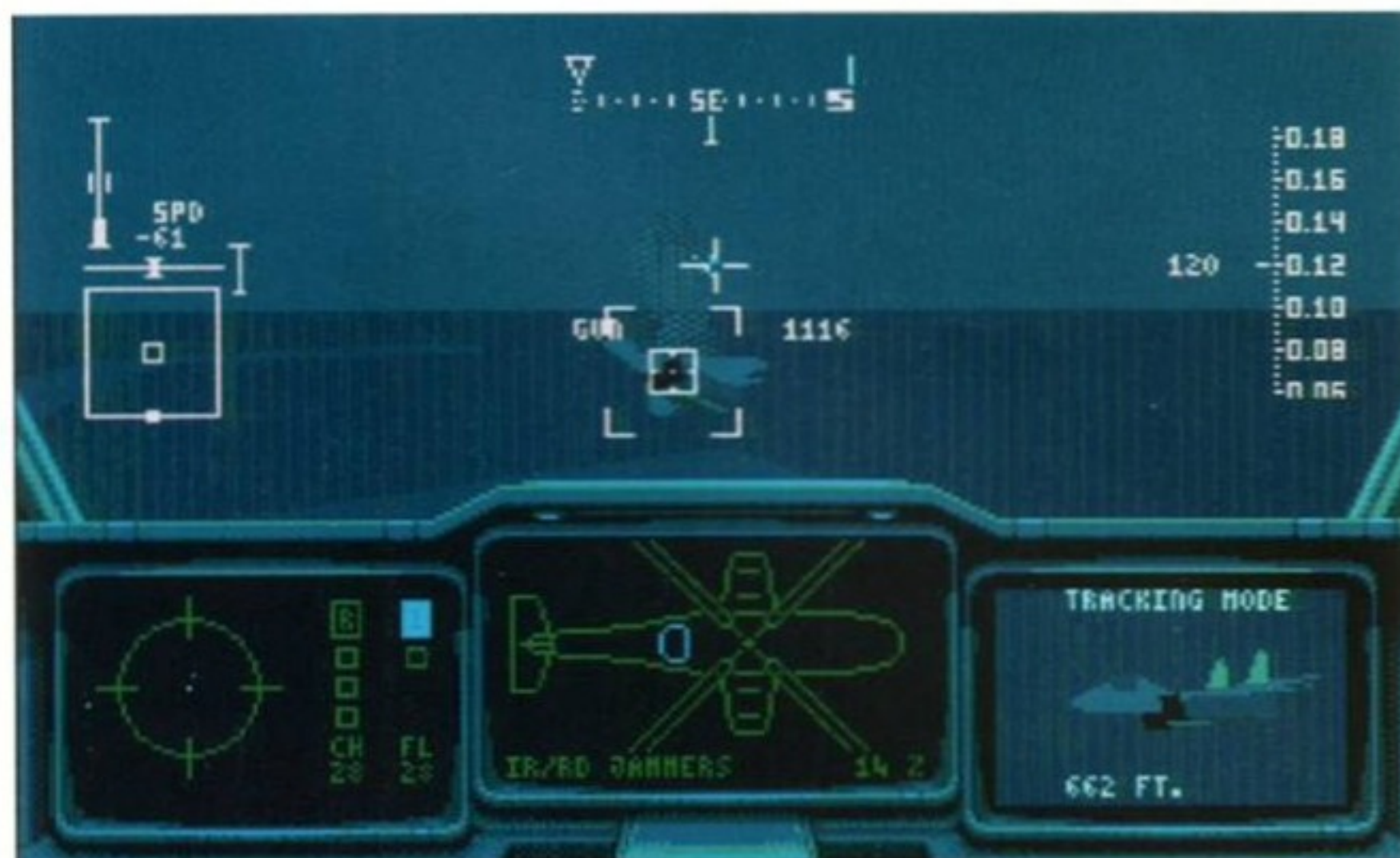

*Thunderhawk*, being an object of fantasy, has to build and maintain its own mystique. The clever animated briefings and reports that fall between each mission help to establish a mythos. There's even a cartoon intro sequence explaining the unit's inception, a dressing that only arcades or adventures have had to date. This package is a complete one, establishing *Thunderhawk* as the hybrid it really is.

*"Thunderhawk is a non-stop shooting war where there are only the quick and the dead."*

Really?

The biggest problem is that it plays for keeps and it plays fast. There's no flying to-and-from missions, you're delivered within striking distance at the start. So, good pilots will find themselves progressing rapidly through the 60 missions simply because each sortie tends to be a short, swift exercise; a factor which limits lesser pilots' progress.

Reality fans may claim *Thunderhawk* lacks 'serious military credibility'. This is a mistake: sure, everything isn't accurate down to the last rivet, but in terms of playability and speed it's leagues ahead. *Gunship* now looks its age and can't hope to match state-of-the-art 1991 3D work. If there is one thing that hasn't been simulated, though, it's any flaws. Even the best modern technology has at least one foible - a 'flight characteristic' - that has to be worked around, but *Thunderhawk* has none.

*Thunderhawk* creates a thrilling 3D environment, filled to the brim with bullets, blasting and battles. Its unique control system promotes fast learning and allows the game itself to start at a sprint. Trick flying and quick firing are the only routes to survival from the word go. Segmented well with animated briefings, each campaign is a story that you create with brave deeds and hot flying.

Trenton Webb

### Thunderhawk Core Design ■ £30.99

- The excellent control system frees the game from the normal sim constraints.
- Six campaign stories, each with 10 tough sorties.
- The animated intro and briefing screens add continuity.
- High-speed simulation with more hostile fire than you could possibly care to imagine.
- Futuristic violence in a fast vector world, an action adventure in every sense of the word.

AMIGA  
**Verdict 90%**  
FORMAT

10 MARKET PLACE  
ST. ALBANS  
HERTS AL1 3DG  
TEL (0727) 56005/41396

# Hobbyte

THE GALLERY  
ARNDAL CENTRE  
LUTON, BEDS LU1 2PG  
TEL (0582) 457195/411281

COMPUTING  
ESTABLISHED 7 YEARS

## AMIGA STARTER PACK

Full Amiga 500 pack, WITHOUT Cartoon Classics/Screen Gems software: BUT WITH:  
15 disc Hobbyte PD Greats pack, including Virus Killers, the Best Star Trek and other top ten games, Arcade Classics, Board Classics, Best of the Utilities, Home pack including Word Processor, Spreadsheet, Database,  
10 blank disks, mouse mat, Joystick

512K AMIGA £299  
1 MB AMIGA £325

1MB AMIGA

## AMIGA GAMES PACKS

CARTOON CLASSICS OR SCREEN GEMS  
Full Amiga 500 pack, PLUS: Lemmings, The Simpsons - Bart v The Space Mutants, Captain Planet and the Planeteers, Deluxe Point III (Deluxe Point II with 512K Cartoon Classics)

OR Screen Gems software: Shadow of the Beast II, Back to the Future II, Days of Thunder, Nightbreed, Deluxe Point II

512K AMIGA £329  
1MB AMIGA £349

DP III instead of DP II (1MB only) ADD £40  
Screen Gems S/W Pack only £39  
Cartoon Classics S/W Pack only £49

1MB AMIGA

## AMIGA THE LOT!!

EVERYTHING YOU COULD EVER NEED!!

CARTOON CLASSICS OR SCREEN GEMS GAMES PACK

AS LEFT, PLUS: 10 GREAT INDIVIDUALLY PACKAGED GAMES - previous RRP's £19.99-£39.99 each, phone to choose from current list of 15, or leave it to us! Children's games available.

15 DISC HOBBYTE PD GREATS PACK, including Virus Killers, the BEST Star Trek Computer Conflict, Breakout and construction Kit, Blizzard and other games, Arcade Classics, Board Classics, Shoot-em-Up Classics, Best of the Utilities, Home pack including Word Processor/Spell Check, Spreadsheet, Database

Dust Cover, 10 Blank Discs, Disc Box, Mouse Mat, Microswitch Turbo Joystick  
512K Amiga £365  
1MB Amiga £389

WITHOUT CARTOON/SCREEN GEMS S/W DEDUCT £20

1MB AMIGA

## ABSOLUTE BEGINNERS PACK

FULL AMIGA 500 PACK, PLUS:

POSTMAN PAT, SNAP, SNAKES AND LADDERS, LUDO  
FUN SCHOOL 2 AND FUN SCHOOL 3

(specify under 6 years, 6 to 8 years, or 8+ years) (specify under 5 years, 5 to 7 years, or 7+ years)

12 stunning UK educational games with beautiful pictures, exciting animation and music that help to develop number, word and other skills. Up to 6 skill levels.

Conform to National Curriculum requirements.

HOBBYTE EDUCATIONAL PACK, featuring up to 12 'Learn while you play' games (varies according to age group)

HOBBYTE 30 EASY CHILDREN'S GAMES,

10 disc pack inc; Train Set Game, Flashier.

JOYSTICK

512K AMIGA £355  
1MB AMIGA £375  
ABSOLUTE BEGINNERS S/W PACK £55

4-9 YRS

HOBBYTE EXCLUSIVE

## AMIGA FIRST STEPS

EXPANDED EDUCATIONAL/APPLICATIONS PACK

FULL AMIGA 500 PACK, PLUS:

A501 512K RAM expansion

Lets Spell at Home, Music Mouse, Prowrite WP, InfoFile spreadsheet, Deluxe Point II, Deluxe Print, Music Mouse, LOGO, Talking Turtle, BBC Emulator, 5 BBC programmes, 10 discs, DOs and DON'Ts poster, Resource File, In Pack Video, NAPE Booklet.

HOBBYTE EDUCATIONAL PACK, featuring up to 12 'Learn while you play' games (varies according to age group)

HOBBYTE 30 EASY CHILDREN'S GAMES, 10 disc pack inc; Train Set Game, Flashier.

JOYSTICK

\*STOP PRESS - 'FIRST STEPS' NOW £449

DP III instead of DP II (1MB only) ADD £40  
FIRST STEPS SOFTWARE UPGRADE PACK £149

£525

## A3000 WITH 1950 MONITOR OFFER

A3000 25/40 25 MHz, 40 MB HD, 2MB RAM, 1 x 3.5" 880K floppy, keyboard £1989

A3000 25/100 25 MHz, 100 MB HD, 2MB RAM, 1 x 3.5" 880K floppy, keyboard £2289

1MB static RAM for A3000 £199

PHONE FOR DETAILS OF 1950 OFFER

A3000 Trade in price as above less £150 - £200. Please phone. Please see under "Extras" for additional expansion

## CBM CDTV

A revolutionary new concept in home entertainment and education. Amiga based with a professional CD system and infra-red remote control unit, it is similar in appearance to a VCR and simply connects to your television (and your hi-fi system if you wish) for incredible interactive multimedia sound and graphics effects. The CBM CDTV plays:

STANDARD CD AUDIO DISCS:

CD + GRAPHICS DISCS: Display on-screen graphics as accompaniment to CD audio track.

CD KARAOKE DISCS: With CD audio backing, the words displayed on the TV screen, mixer unit and stereo microphone, you have your own high quality Karaoke system for a fraction of the normal commercial cost.

CD MULTIMEDIA TITLES: Similar to computer games and educational titles but better. CDs have a massive 540MB storage capacity. Controlled by user via remote control unit.

CDTV SYSTEM £599

INCLUDES: CDTV player, infra red remote control unit with batteries, Hutchinsons Encyclopaedia inc 25,000 entries, 7,000 biographies, 250 tables, Lemmings - top selling game, Welcome disc, disc caddy, manual, cables.

## CDTV KARAOKE

CDTV KARAOKE SYSTEM £699

As above, complete with Sony Stereo Microphone, Mixer Unit, leads, plus any one Karaoke disc, containing 18 top Karaoke titles.

CDTV PROFESSIONAL KARAOKE SYSTEM £999

As KARAOKE system above.

PLUS any TWO Karaoke discs, containing 36 top Karaoke titles.

PLUS a pair of high quality Bose Lifestyle Roommate Speakers and leads, (30W rms full range powered speaker system) for truly professional sound.

Telephone for full list of CD+G, Multimedia and Karaoke Titles

## NO DEPOSIT CREDIT FACILITIES (UK mainland)

Credit terms at 34.8% APR (variable) can be arranged for purchases over £150, subject to status. Competitive leasing schemes are also available for businesses, including sole traders and partnerships. Just tel for written details and application form.

COMMODORE 1084S OR PHILIPS 8833 COLOUR MONITOR,  
LEADS £220 WITH ANY PACK  
STAR LC24-200 COLOUR PRINTER AND LEADS £279 WITH ANY PACK

## AMIGA 1500/2000

Full UK spec, latest version with 1MB RAM, mouse, expansion as B2000, manuals and operating discs, available as:

A1500/2000 PLUS: 15 DISC HOBBYTE PD GREATS PACK

including Virus Killers, the BEST Star Trek, Computer Conflict, Breakout and construction Kit, Blizzard and other games, Arcade Classics, Board Classics, Shoot-em-Up Classics, Best of Utilities, Home Pack including Word Processor/Spell Check, Spreadsheet, Database.

	Without monitor, with modulator	With 1084SDI monitor
DUAL DRIVE	499	719
SD + 2091/52 MB QUANTUM HD	799	999
SD + 2091/52 MB QU HD + 2MB	869	1069
SD + 2091/100 MB QU HD	929	1129

A1500/2000 PLUS: A1500 SOFTWARE PACK including The works, Platinum Database, WP, Spreadsheet, Deluxe Point III, Sim City, Populous, Their Finest Hour, Battlechess, A-Z of Computer Jargon, 'Get the Most' from your Amiga.

PLUS: 15 DISC HOBBYTE PD GREATS PACK AS ABOVE

	Without monitor, with modulator	With 1084SDI monitor
DUAL DRIVE	649	859
SD + 2091/52 MB QUANTUM HD	949	1159
SD + 2091/52 MB QU HD + 2MB	1049	1229
SD + 2091/100 MB QU HD	1079	1289

## A500 TO 1500/2000 TRADE IN

Dual Drive, with Hobbyte 15 Disc PD Greats Pack,

but without A1500 software pack or monitor £369

As above with A1500 S/W pack £479

As above with A1500 S/W pack plus 1084 SDI £679

Single Drive plus 52MB Quantum Hard Drive and 2091 controller, with Hobbyte 15 Disc PD Greats Pack,

but without A1500 software pack or monitor £689

As above with A1500 S/W pack £799

As above with 1500 S/W pack plus 1084 SDI £999

## EXTRAS inc VAT

Star LC200 colour printer with leads	£195
Star LC24-200 colour printer with leads	£299
Citizen Swift 9 pin colour printer with leads	£189
Citizen Swift 24 pin colour printer with leads	£299
Commodore 1084SDI or Philips 8833 MkII Stereo colour Monitor, + leads	£227
Second external 3.5" drive with daisychain through port and disable switch	£49
PC 880 anti-clickext. drive	£55
A501 The Official CBM 512K RAM exp.	£44
512K RAM Expansion + Clock	£29
1.5 MB RAM Board (needs KS 1.3)	£75
GVP A500 50 MB HD + 2MB	£619
AT once AT Emulator for A500	£199
A590 20MB Hard drive	£264
A590 20MB Hard drive + extra 2MB	£319
A590 52MB Hard drive	£399
A590 52MB Hard drive + 2MB	£469
10 blank discs 100% guaranteed with PIN no in box	£6.99
50 blank discs 100% guaranteed with PIN no	£16.99
Rendale 8802 Genlock	£179
G2 Genlock for 2000/1500	£649
A2300 internal genlock for 2000/1500	£99
A2088 XT Bridge Board, 640K, MS DOS 3.3 + 5.25" drive, for 2000/1500	£139
A2058 8MB RAM exp board, populated to 2MB, for 2000/1500	£199
BUP 8MB RAM exp board, pop to 8MB for 2000/1500	£349
A2630 68030 card, populated to 2MB for 2000/1500	£999
A2320 Display Enhancer card (Flicker fixer) for 2000/1500	£249
A2091/52MB Quantum Autoboot HD for 2000/1500	£349
A2091/100MB Quantum Autoboot HD for 2000/1500	£499
A1950 high res colour monitor for 2000/1500 (needs A2320) and 3000	£399
A500/1500 modulator	£23

## ORDERING :

TELESALES NO: (0727) 56005

Next day delivery for credit card orders placed before 4.00pm subject to availability. Alternatively

send cheque, postal order, bankers draft or official order (PLCs, Education and Government bodies only) to: Dept.

AF, Hobbyte Computer Centre, 10 Market Place,

St. Albans, Herts AL3 5DG. Please allow 7 working days for

cheque clearance. Subject to availability, despatch is normally

within 24 hours of receipt of cleared payment. Prices are correct at

time of going to press, however, we are sometimes forced to

change them, either up or down. Please check before ordering.

DELIVERY CHARGES: UK Mainland (not Highlands)

Small consumables & software items Despatched by post, please check charges when ordering

Other items, except lasers Next day courier service, £10 per box

Laser printers Next day courier service, £17.50

Offshore and Highlands Normal rate plus £20 + VAT per box

In addition we offer the following express services:

Saturday deliveries Normal rate plus £10 + VAT per box

7am to 9am next day Normal rate plus £10 + VAT per box

Am next day Normal rate plus £5 + VAT per box

CALLERS WELCOME AT OUR BRANCHES OPEN 9-5.30, Monday to Saturday

Amiga prices, except where stated are inc. VAT. E.&O.E.

STEAR

TELE-ORDER (0727) 56005

**H**ands up who remembers the golf game *Leaderboard*? Only the excellent *PGA Tour Golf* has managed to match its stylish and addictive golfing gameplay. So how does the latest golf sim shape up in a fairway of games which have attempted to go one better than the *Leader*, which is now showing its colours on the budget circuit?

**It's a game of 18 holes Brian**

You know exactly what to expect from a golf game. The conditions have got to be realistic, the club selection's got to be easy and the graphics need to look something like a large area of greenery with 18 flags sat on it. On the surface *Challenge Golf* follows these criteria, but start playing the game and a very different impression is formed.

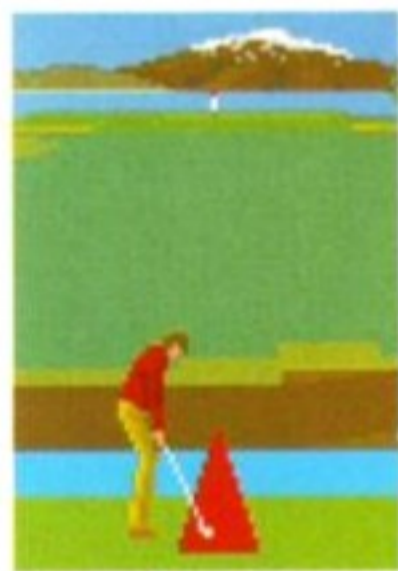

On the tee, Steffi Graf has thrown the grass in the air and muttered to herself.



She's choosing a club, and yes she's gone for the one wood - old faithful.

This is the sort of game that'll soon have you tearing clumps of hair out of your head in sheer frustration. In this case Gabi is finding life difficult at the very trying Banff Springs course, which is apparently somewhere in the States. The graphics, aren't terribly true to life, but you're left feeling that if real golf is this uninspiring then Nick Faldo is one over-rated chappy.

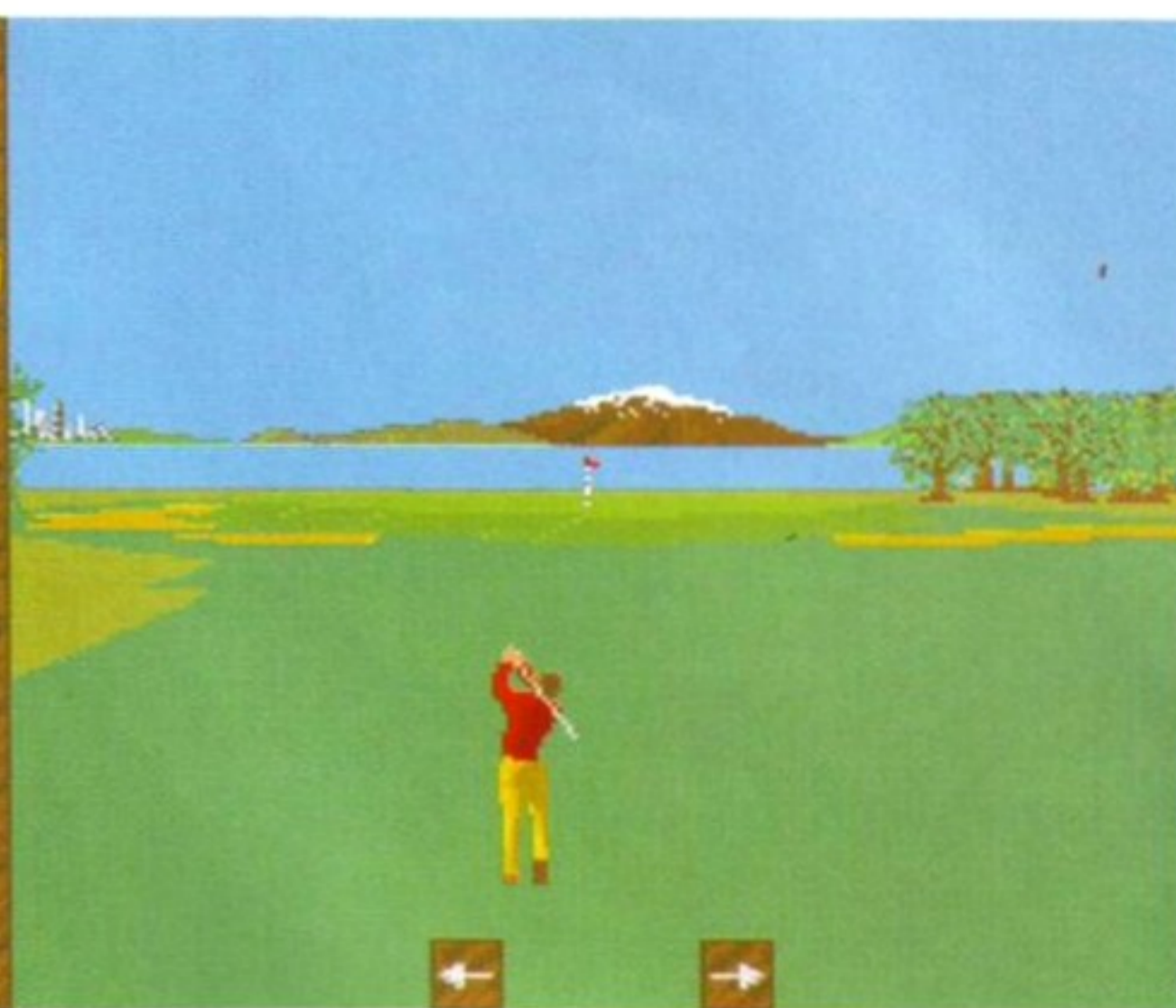
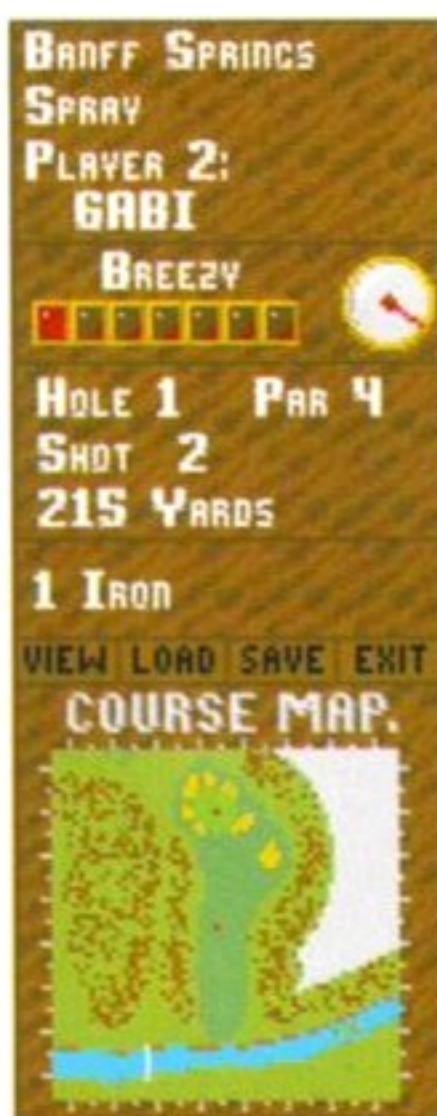

# Challenge Golf

Swinging into the ball, get the power on full and you'll have a job controlling the direction.

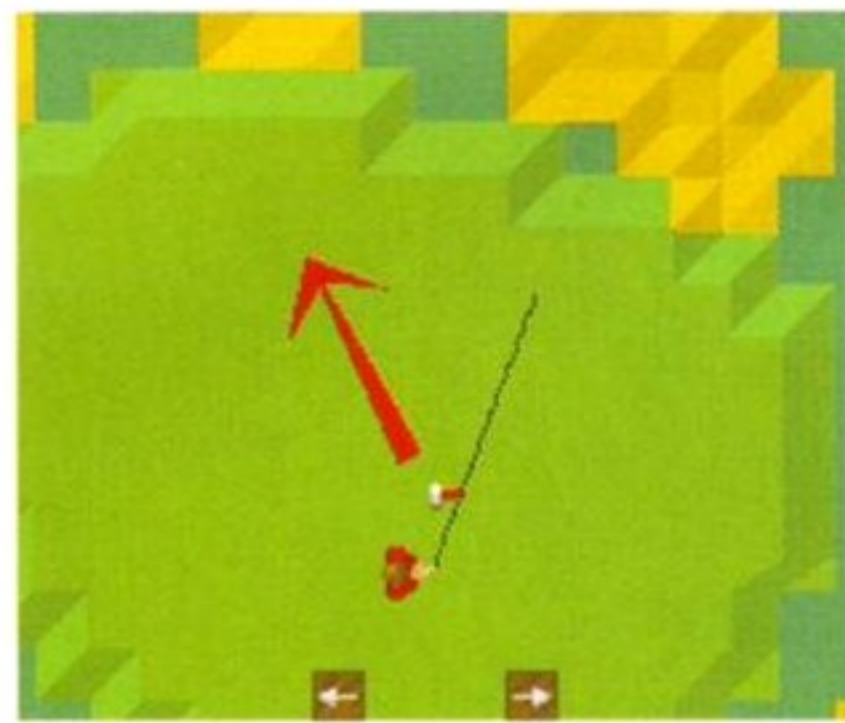

Don't ask me how you're meant to concentrate on your putt when there's a huge great red arrow obscuring the cubist abstract green. Faldo never had these hassles.

The menu screen is where conditions are chosen, names entered, players loaded and saved, sounds turned on and off and the skill level chosen. The screen itself is tatty and you soon realise that things don't bode well for the actual game. Having set up your options you can choose to either shoot at the driving range or take part in a bit of strokeplay. Additionally, computer-controlled opponents can be selected, simply pick the one that looks like he'll get the beers in after the game.

The driving range is entirely bland, but then you could level that criticism at real driving ranges. Different clubs can be chosen, enabling you to perfect your swing, though perfecting your swing is the least of your problems with this game.



**But why are the balls that funny shape?**

The main play screen presents you with a 'behind the shoulder' view of the fairway with your golfer sat in the middle straddling a large red arrow. On the left-hand side of the screen is a miniature map of the golf course, the currently selected club, a wind meter and the load, save and exit options.

To choose a club all you have to do is simply click on the club screen and cycle



Weeeeeeeeee, the ball whizzes down the fairway and then, erm, lands. What fun.

There are four whole courses to choose from, fortunately, there isn't a three-year waiting list and you don't have to sit in front of a committee to become a member.

Hole One at Sotogrande and there's a massive challenge on. Simply keep hitting the ball up the fairway until you reach the small smooth area of grass, then you hit the ball a bit softer until it goes into the little hole!

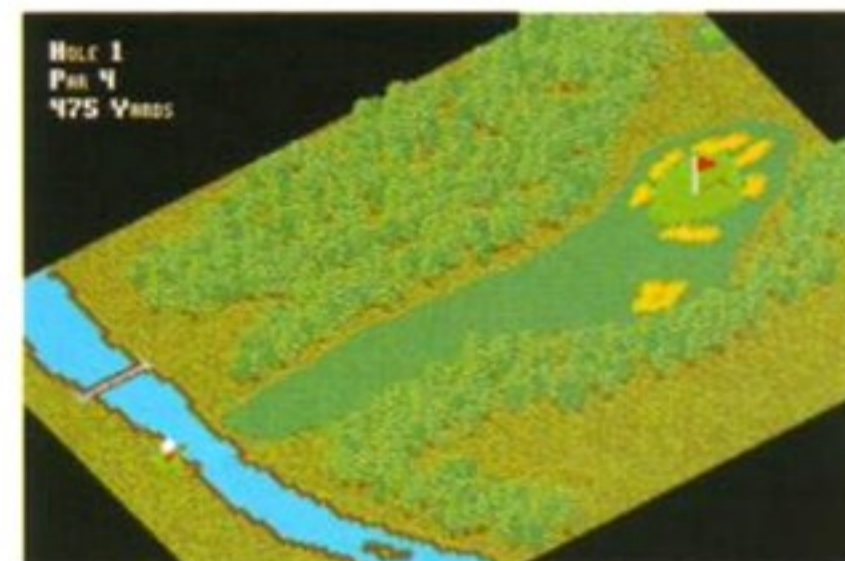

nothing new to the arena of computer-simulated golf except a bad feeling that people actually want you to pay money for this game.

In a flight simulator you have realistic combat conditions, in a racing game you have pitstops, but in this golf simulation you have large red arrows and some dreadfully simplistic gameplay.

If *Challenge Golf* had turned up in the public domain then, no doubt, it would have received rave reviews and a large pat on the back. But it isn't public domain and it isn't a challenge. Either go and buy *PGA Tour* or *Leaderboard* (the super-doooper 27 zillion course pack), or wait for MicroProse's golf game, because *Challenge Golf* brings about as much credibility to Amiga games entertainment as Japan does to whale conservation.

Andy Hutchinson

**Challenge Golf**  
On-line Ent. ■ £25.99

- Tame graphics and sparse samples.
- Gameplay is lacking, lasting interest is minimal.
- Clumsy shot direction controls.
- Annoying pauses every time an overhead view is shown.
- Massively simplistic graphic depiction of a putting green.

AMIGA  
**Verdict** 45%  
FORMATE

# THE BEST IN QUALITY GAMES

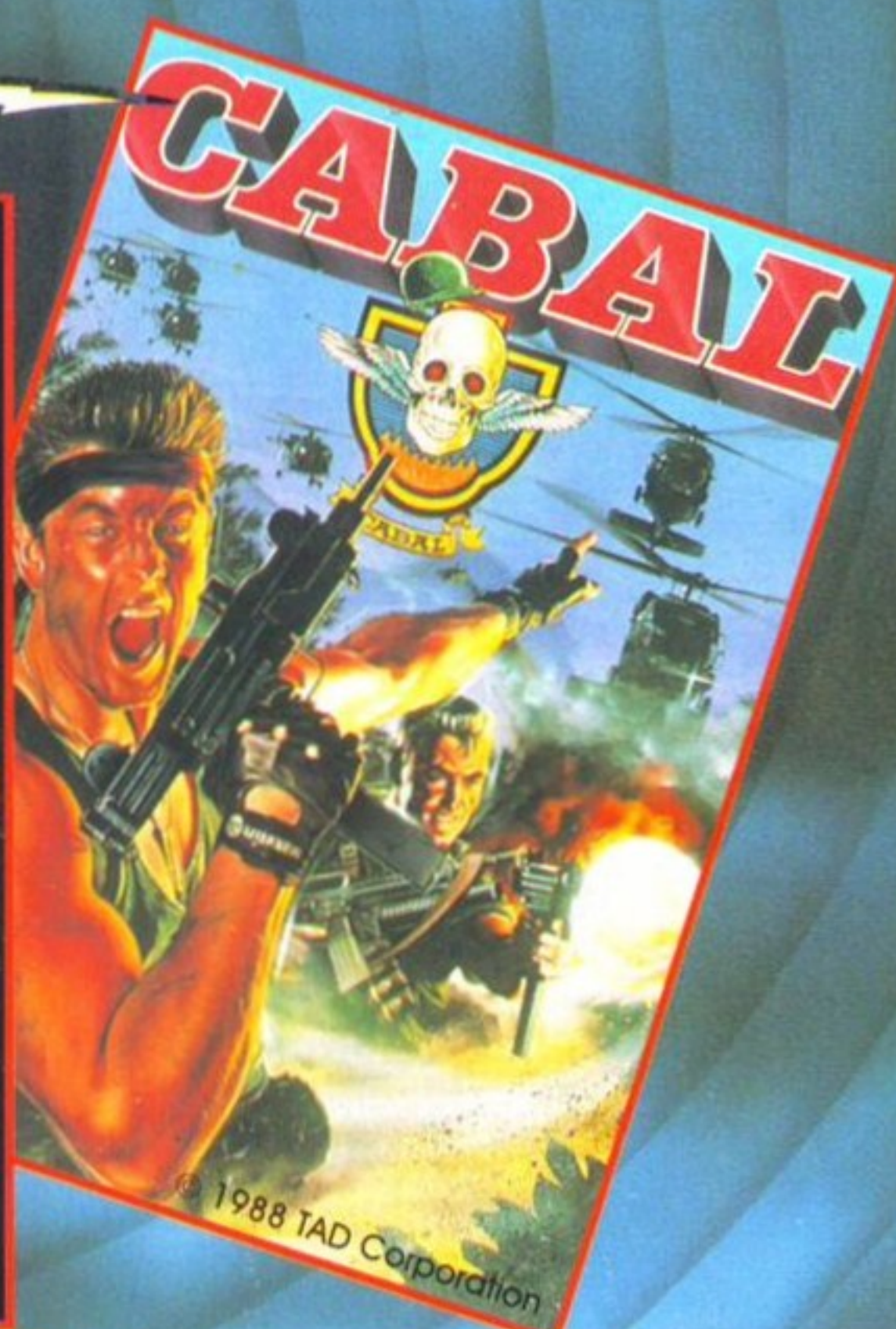
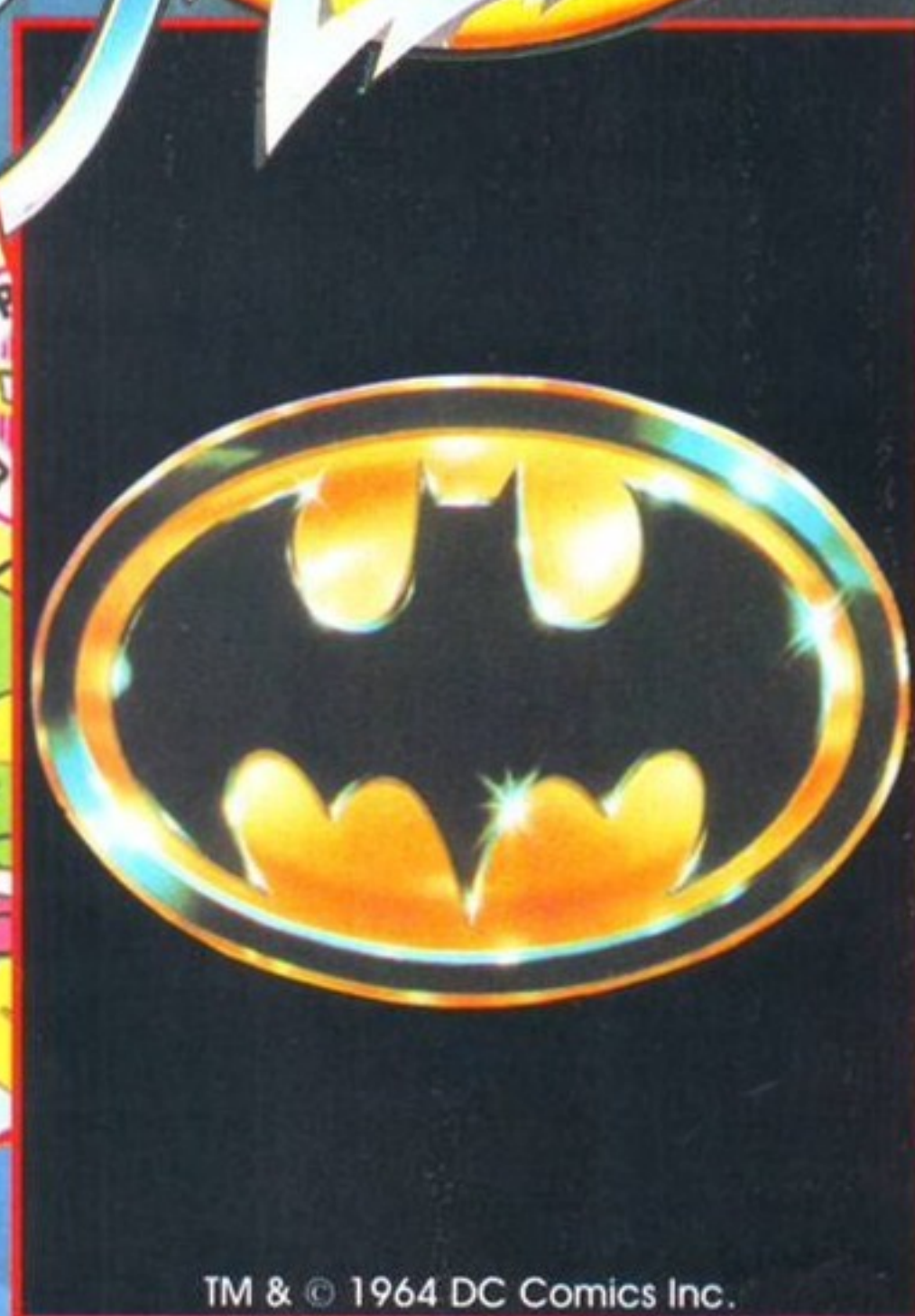
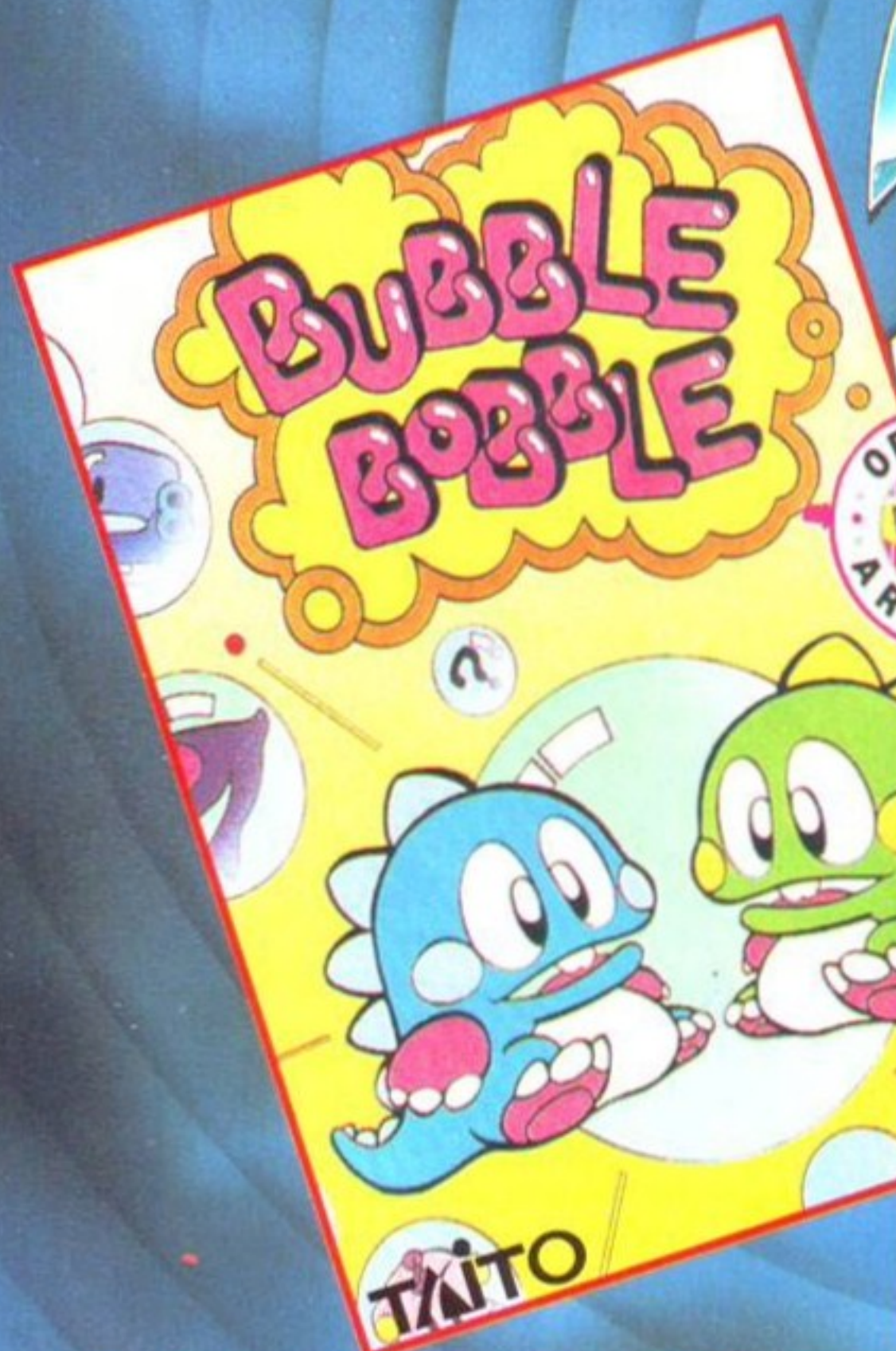
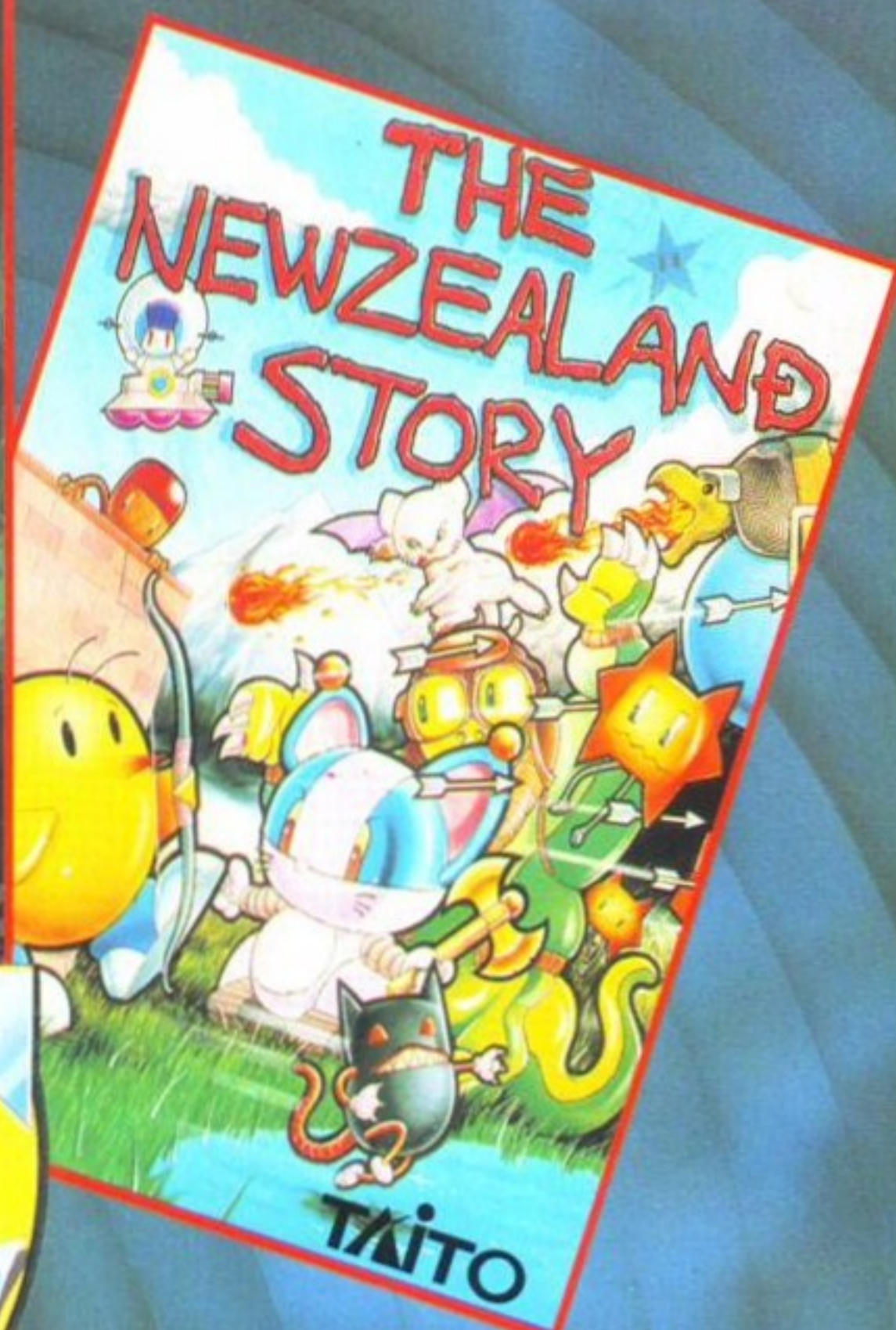
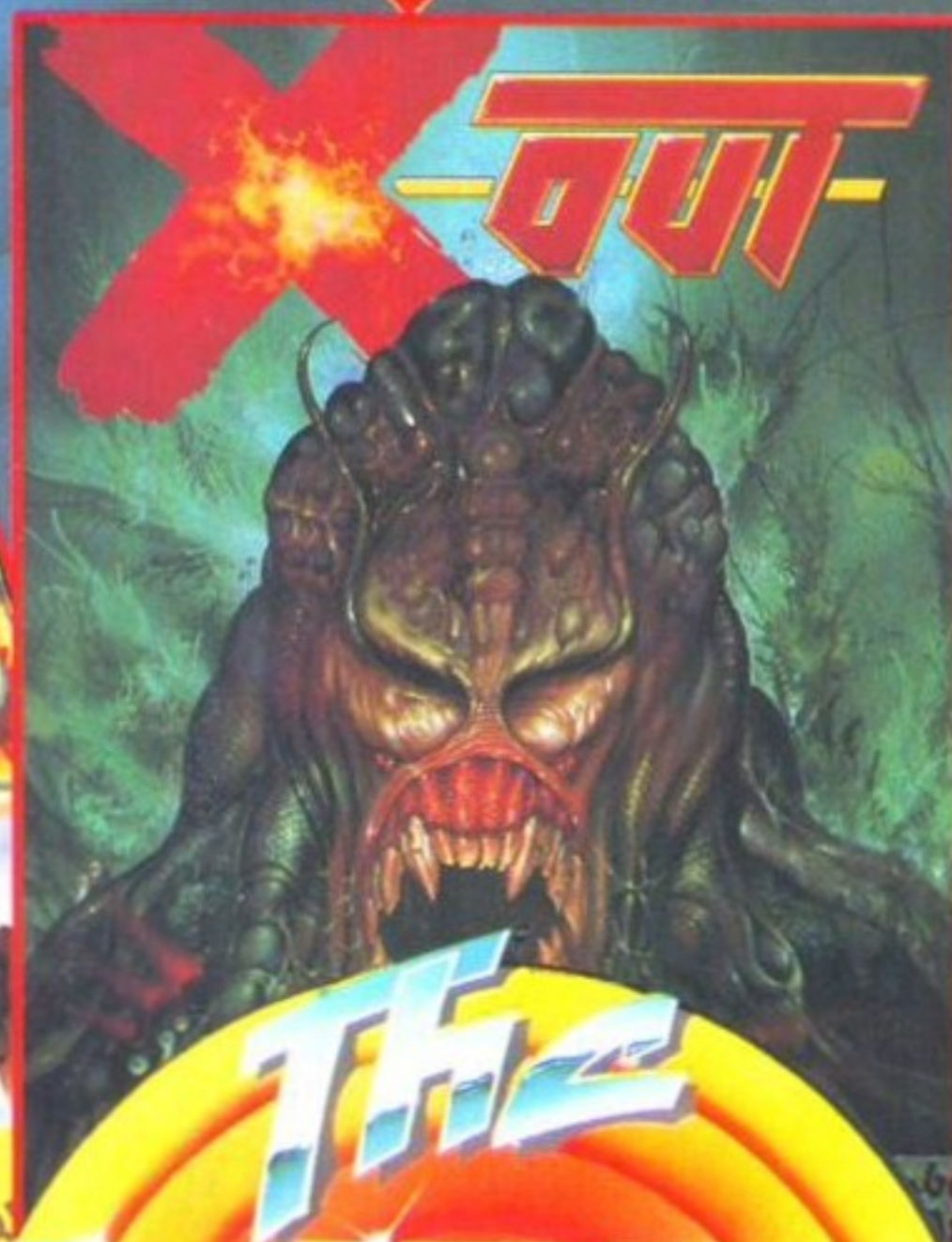
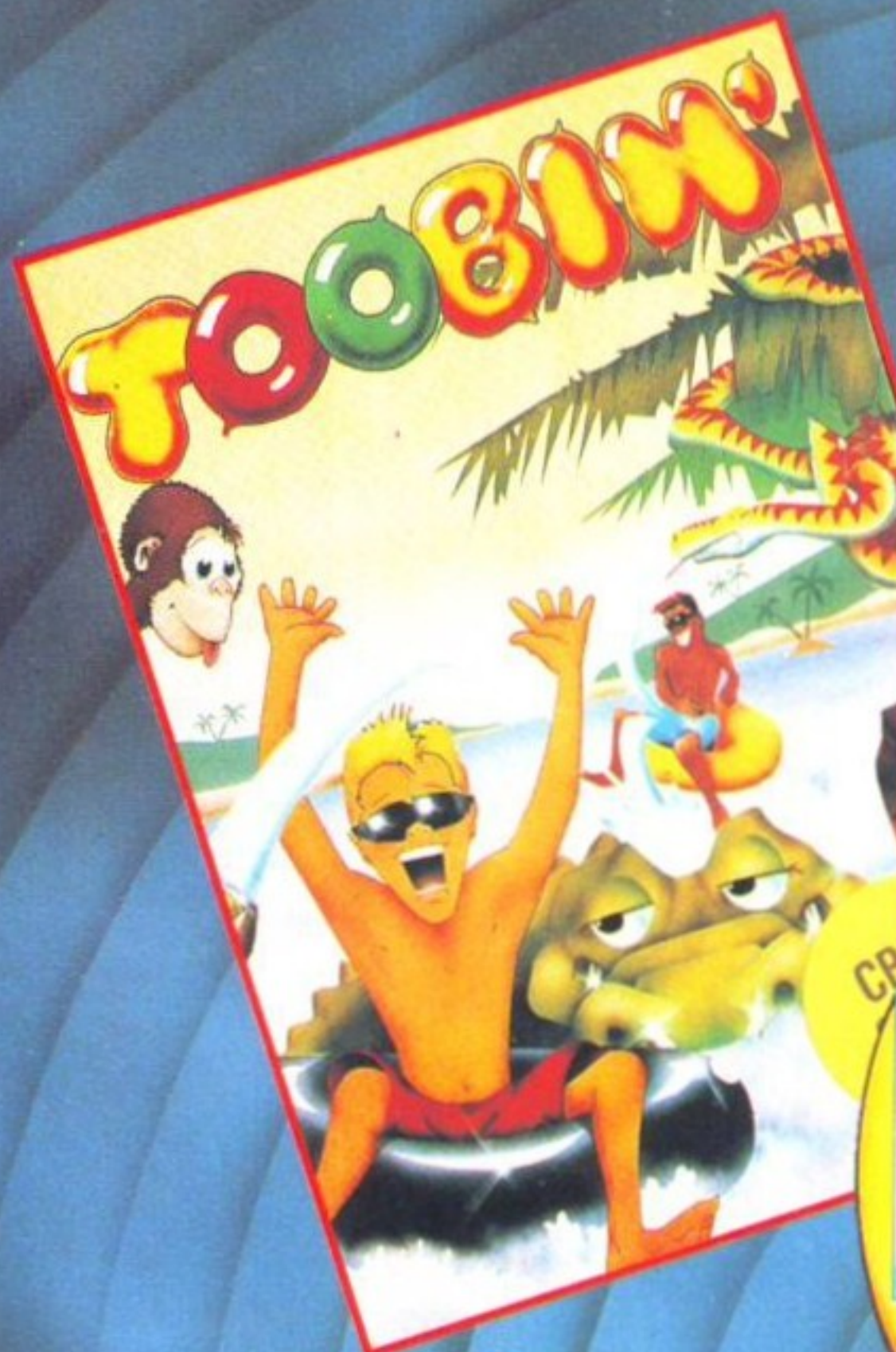

**AT POCKET-MONEY PRICES!  
ONLY £3.99 EACH**

ALL AVAILABLE FOR: SPECTRUM · COMMODORE · AMSTRAD

**HIT NAMES · HIT GAMES · HIT SQUAD**

Epilogue time, or in other words: time to wrap up the Screenplay pages by mentioning the games that just squeezed in and to fill you in on the important chart news...

# Spoutro

## Hero Quest – The Return of the Witchlord

Gremlin ■ £14.99

**Verdict 85%**

Gremlin's spiffy conversion of the low-level hack-and-slash board-game now has more quests.

*Return of the Witchlord* is part two of the sword-waving, spell-casting tale of warriors and wizards. Ten new missions are on offer, to test the mettle of even the best questers.

These new quests are tough stuff, with hordes of hard nasties inside the very first door. So those saved parties from *Hero Quest*, complete with all their purchased weaponry and magic armour is going to be essential if you are to make a successful assault on the Witchlord.

10 new challenges await the party and all are proper Hero Quest (the board game version) adventures so you can be sure that all have a few surprises tucked up their armoured sleeves. Yet they all use the same interface established in *Hero Quest*, so play will be just as slick.

Previously when you played the game it was so easy (even for the solo player) that managing four characters was a cinch, so the data disk has arrived just in time to catch the preliminary buzz of the original release. There has to be a huge number of heros questing out there already, with the original riding high at number seven in the charts (see overleaf) and this data disk deserves to be an equal success. *Hero Quest* is needed in order to run *Return of the Witchlord*, but it has to be an absolute must for any Barbarian, Elf Wiz or Dwarf who want who want more Chaos Warriors to kill, zombies to slice, skeletons to slice....



A magical history score,  
or that was the month that was...

### THIS MONTH'S SCORES

<b>Mega-lo-Mania</b>	91%
<b>Jimmy White's Snooker</b>	91%
<b>Thunderhawk</b>	90%
<b>Bart vs the Space Mutants</b>	81%
<b>Llamatron</b>	89%
<b>Frenetic</b>	67%
<b>Atomino</b>	72%
<b>Navy Seals</b>	65%
<b>Challenge Golf</b>	45%
<b>Battle Chess II</b>	76%
<b>The Cardinal of the Kremlin</b>	59%
<b>Swap</b>	59%
<b>Sliders</b>	60%
<b>Armalyte</b>	51%
<b>Striker Manager</b>	53%
<b>Billiards II Simulator</b>	58%
<b>Arcade Trivia Quiz</b>	57%
<b>Stack Up</b>	80%
<b>Hero Quest Data Disk</b>	85%

### A MONTH AGO

<b>R-Type II</b>	88%
<b>RBI 2</b>	84%

<b>Manchester United Europe</b>	80%
<b>Barbarian</b>	76%
<b>Proflight</b>	75%
<b>Germ Crazy</b>	75%
<b>Mercs</b>	72%
<b>Gunboat</b>	72%
<b>Impossible Mission</b>	72%
<b>Life and Death</b>	70%
<b>Ghost Battle</b>	69%
<b>Sharkey's Moll</b>	69%
<b>Frostbyte</b>	69%
<b>Prehistorik</b>	68%
<b>Tangram</b>	60%
<b>Bill and Ted's Ex. Adventure</b>	58%
<b>Champion of the Raj</b>	57%
<b>John Lowe's Ultimate Darts</b>	55%
<b>Crime Doesn't Pay</b>	54%
<b>LED Storm</b>	46%
<b>Halls of Montezuma</b>	43%
<b>Bionic Commando</b>	43%
<b>Interceptor</b>	42%
<b>Beastbusters</b>	41%
<b>Thai Boxing</b>	16%
<b>Protector</b>	13%

<b>Flightpath 737</b>	10%
ONE YEAR AGO	
<b>Operation Stealth</b>	90%
<b>Supremacy</b>	90%
<b>Monty Python</b>	88%
<b>Magic Fly</b>	88%
<b>Shadow of the Beast II</b>	87%
<b>Extase</b>	86%
<b>Time Machine</b>	85%
<b>Tie Break</b>	84%
<b>Plotting</b>	81%
<b>Simulcra</b>	80%
<b>Venus the Fly Trap</b>	79%
<b>Thunderstrike</b>	77%
<b>Unreal</b>	74%
<b>Gold of the Aztecs</b>	73%
<b>Bomber Mission Disk</b>	71%
<b>Zirix</b>	68%
<b>Starblade</b>	67%
<b>Codename Iceman</b>	64%
<b>The Colonel's Bequest</b>	60%
<b>Web of Terror</b>	48%
<b>Yolanda</b>	46%

## Arcade Trivia Quiz

Zeppelin ■ £7.99

(Verdic) 57%

Dear *Points of View*, why, oh why, do people still keep producing quiz games where you win pretend cash? Despite the obvious flaw (you don't get the dosh) they are still massively intriguing, especially when played by a group, with everybody yelling wrong answers. *Arcade Trivia Quiz* spoils this advantage with a dodgy joystick system that you don't so much control as react to. The categories flash past while the timer kicks down so you're penalised for waiting for a topic you can answer, which seems a bit unfair. The questions are varied and offer some reasonably outrageous answers. The game looks pretty but can't escape its own essential pointlessness. A reasonable example of a strange genre *Arcade Trivia Quiz* isn't horrendous it just isn't that hot.



## The Games: Summer Edition

Kixx ■ £7.99

(Verdic) 51%

Ah yes! I remember when these multi-event sports simulation games were all the rage. Unfortunately the idea had been pretty much wrung dry by the time the Summer Edition of Epyx's *The Games* series had been reached. It follows an earlier proven formula, with 16 different sporting events to try, all controlled from the joystick. The game itself is well presented with a number of varied sections, but the whole thing seems like a bit of a waste of time. The controls are complex and confusing and the loading is painfully slow. Still, it's fairly cheap and worth a look if you REALLY have to have an Olympic simulation. Otherwise, I wouldn't bother if I were you.

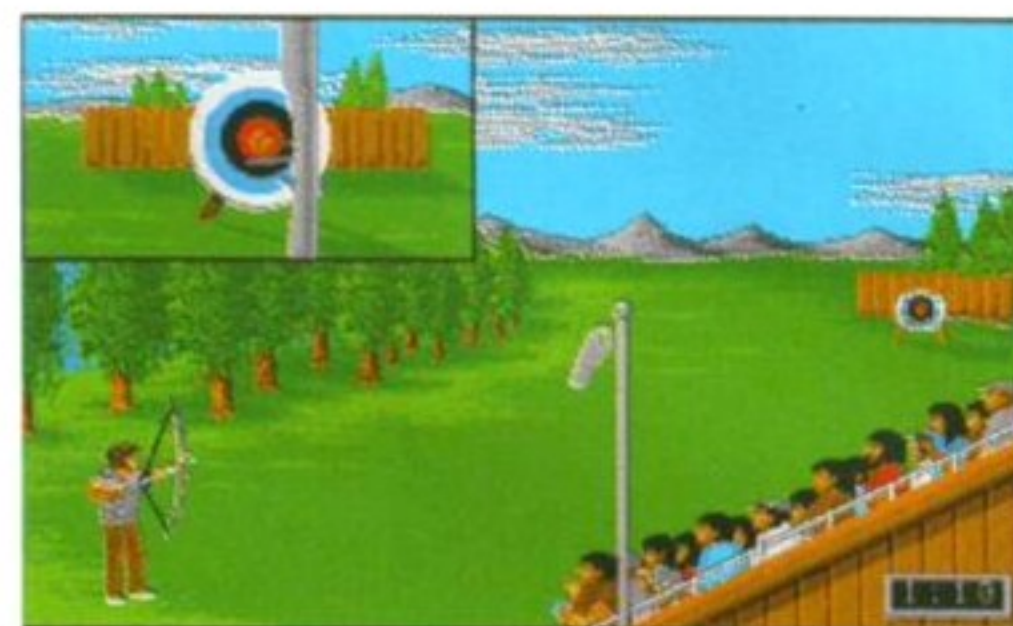

## Armalyte

Thalamus ■ £25.99

(Verdic) 51%

This frenetic space blast was originally released a few years ago on the C64 to massive critical acclaim. Now that an Amiga version has arrived, you'd expect improved audio-visuals and more fluid gameplay, but unfortunately, the sound is weak, the graphics are gaudy and the game itself is rather unplayable. As far as the appearance goes, the brightly coloured scenery leaves the background looking rather flat, instead of the futuristic image that it should have. It's quite a struggle to get the ship to respond to the controls, so the movement just doesn't feel right. *Armalyte's* programmers, Arc also wrote *R-Type II*, which is a much better game than this will ever be.



## Striker Manager

D&H Games ■ £25.99

(Verdic) 53%

There are already a host of soccer management games on the market, with Anco's *Player Manager*, without a shadow of a doubt, at the top of the heap. So can D&H hope to knock this classic from its position? The answer is actually no. *Striker Manager* has some nice menu graphics and option screens, but that's about it really. Instead of trying to create a frantic and realistic soccer atmosphere it bombards you with lists of attributes and options that only go to confuse the player. Although it seems quite a deep game, the lack of explanations soon become frustrating. Another point is that the 'arcade highlights' (the game's attempt at atmosphere) are tragically hilarious!

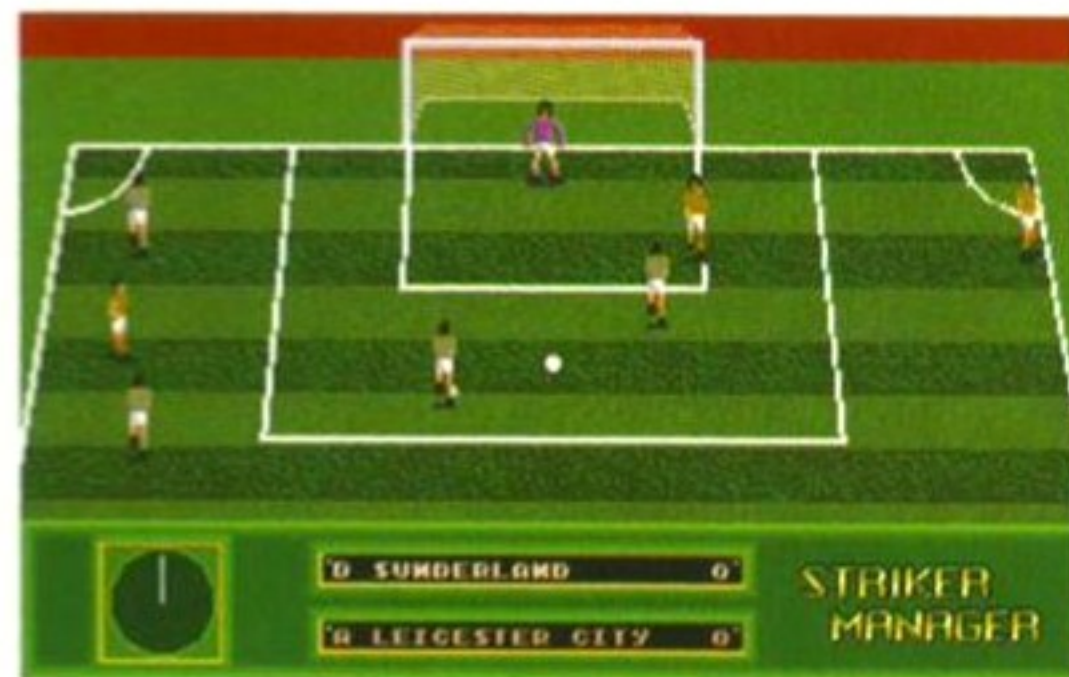

Instead of trying to create a frantic and realistic soccer atmosphere it bombards you with lists of attributes and options that only go to confuse the player. Although it seems quite a deep game, the lack of explanations soon become frustrating. Another point is that the 'arcade highlights' (the game's attempt at atmosphere) are tragically hilarious!

## Billiards II Simulator

Infogrames ■ £19.99

(Verdic) 58%

Isn't it strange that as soon as one unusual style of game appears, another similar game seems to quickly follow. Elsewhere in this issue you'll find a review of the superb *Jimmy White's Snooker* (Page 58), and what should also appear? A billiards simulator! What a coincidence. There's an attempt to flesh out this least-exciting-of-all baize sports up with a number of variants and modes. In between sit a number of static screens to create the impression of being in a casino. There's even a choice of overhead and 3D mode but neither are massively convincing. Unfortunately, Infogrames' version looks rather scrappy and dated next to Virgin's somewhat slicker product. If you have to play a game based on the old 'green' table, it has to be said that Jimmy White's your man. The variety and options offered here can't compensate for Jim's class.



## Stack up

Zeppelin ■ £7.99

(Verdic) 80%

Basically a variation on the *Tetris/Columns* genre. You control sets of traffic symbols as they drop from the top of the grid. The idea is to form lines of three or more matching symbols running vertically, horizontally or even diagonally. Forming rows of four symbols counts as two



lines, making it easier to reach the target. Later levels feature more hazardous obstacles, such as randomly generating blocks that fill the empty gaps on the grid. As you would expect from this type of game, the actual gameplay is extremely simple. Despite this, the going is pretty good fun and you'll soon find that it's strangely addictive - more so than many full-priced games. At the budget price of less than eight quid it's well worth any puzzle game fans having a look.



## BUDGET TOP TEN

1(-)	<b>Full Contact</b>	Team 17
2(3)	<b>Lombard RAC Rally</b>	Hit Squad
3(-)	<b>Xenon 2</b>	Mirror Image
4(4)	<b>North and South</b>	Action 16
5(1)	<b>Fantasy World Dizzy</b>	Code Masters
6(2)	<b>Defender of the Crown</b>	Mirror Image
7(5)	<b>Miami Chase</b>	Code Masters
8(-)	<b>Run the Gauntlet</b>	Hit Squad
9(10)	<b>3D Pool</b>	Mirror Image
10(8)	<b>Little Puff</b>	Code Masters

### Contact!

Congrats all round for Wakefield's globe trotting Team 17, who have stomped, punched,



kicked and nuted their way to number one with Full Contact. The glorious graphics more than make up for the few flaws in the gameplay. They've set new standards for original budget games and their entrance into the full-price sector, with Alien Breed, is eagerly awaited.

### The Hot Spot

The new Number One - F-15 - has (desert) stormed in, can it match the illustrious F-19 for staying power? Both leapt in to the top of the charts the month after their release. F-19 is still stalking the lower reaches



of the Top 30 to this day (although it's hard to spot), but only time will tell if it can deliver its chart ordnance as effectively.

### Game maker

You cannot be serious! Well you can actually, because 3D Construction Kit has built itself a

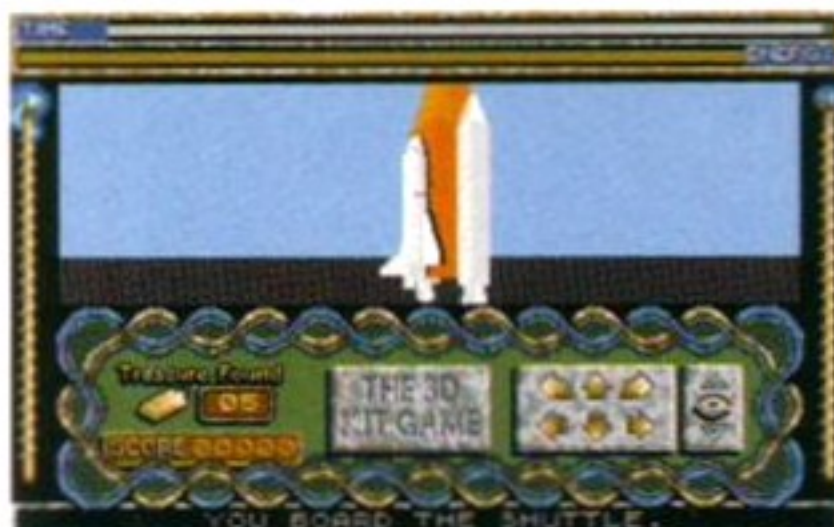

strong chart position. Despite its £50 price tag its interactive potential has already catapulted it to number 24 and it's sure to go higher. It will also provide the ideal retort next time a dour faced ST techie lays the "games machine" trip on you.

### Staying Power?

The brilliant *Monkey Island* continues to hang in there at Number Three, a stunningly high position for an adventure. With *Eye of the Beholder*, *Lemmings*, *Gods*, *Railroad Tycoon*, *PGA Tour Golf*, *F-15 II*, *Speedball 2*, *Kick Off 2* and *F-19* it proves that quality always wins out. All have been on sale for absolutely ages and still they are dominating sales. Strange, but has anyone seen a Turtle recently?



## Below

Ah, you noticed! Well, we were hoping, that being such nice folks you wouldn't ask, but since you have, here's why we haven't reviewed some of the games that are currently in the chart.

*Kick Off 2 - Winning Tactics* - Anco Despite the best efforts of our scouts we have not been able to negotiate a transfer deal.

*Cricket Simulator* - Soundware International. The review has been rained off due to bad light and our need for software before review (SBR) which is a bit like LBW but less conclusive.

*Spirit of Excalibur* - Virgin. Ah no excuses, we let this one slip a few months back. No excuses it's our fault. We have played it though, so here goes: it's a slowish (well very slow) knights game, with some spiffy pics and neat plot. Verdict 62%

## THE AMIGA FULL PRICE CHART

1(-)	<b>New F-15 Strike Eagle</b>	MicroProse	£29.99	FG90%
2(-)	<b>New Manchester United</b>	Krisalis	£25.99	80%
3(2)	<b>▼ The Secret of Monkey Island</b>	Lucasfilm/US Gold	£29.99	FG92%
4(1)	<b>▼ Eye of the Beholder</b>	SSI/US Gold	£30.99	FG92%
5(4)	<b>▼ PGA Tour Golf</b>	Electronic Arts	£25.99	FG90%
6(6)	<b>■ Lemmings</b>	Psygnosis	£24.99	FG92%
7(5)	<b>▼ Hero Quest</b>	Gremlin Graphics	£25.99	85%
8(3)	<b>▼ Kick Off 2 - Winning Tactics</b>	Anco	£12.99	See Below
9(14)	<b>▲ Switchblade 2</b>	Gremlin Graphics	£25.99	70%
10(9)	<b>▼ Gods</b>	Renegade	£25.53	FG90%
11(-)	<b>■ Toki</b>	Ocean	£25.99	78%
12(11)	<b>▼ Railroad Tycoon</b>	MicroProse	£34.99	FG92%
13(7)	<b>▼ Armour-Geddon</b>	Psygnosis	£25.99	85%
14(22)	<b>▲ Life and Death</b>	Mindscape	£25.53	70%
15(8)	<b>▼ Speedball 2</b>	Image Works	£24.99	FG94%
16(15)	<b>▼ Chuck Rock</b>	Core Design	£24.99	80%
17(16)	<b>▼ Cricket Simulator</b>	Soundware International	£24.99	See Below
18(21)	<b>▲ MegaTraveller</b>	Empire	£29.99	70%
19(-)	<b>New Mercs</b>	US Gold	£25.99	72%
20(24)	<b>▲ Supercars 2</b>	Gremlin Graphics	£19.99	80%
21(25)	<b>▲ F-19 Stealth Fighter</b>	MicroProse	£29.99	FG91%
22(-)	<b>New Line of Fire</b>	US Gold	£24.99	80%
23(17)	<b>▼ Kick Off 2</b>	Anco	£24.99	FG94%
24(-)	<b>New 3D Construction Kit</b>	Domark	£49.99	91%
25(27)	<b>▲ Sim City/Populous</b>	Infogrames	£29.99	Compilation
26(26)	<b>■ Super Monaco Grand Prix</b>	US Gold	£25.53	83%
27(30)	<b>▲ Brat</b>	Image Works	£29.99	87%
28(-)	<b>New Spirit of Excalibur</b>	Virgin	£29.99	See Below
29(20)	<b>▼ Panza Kick Boxing</b>	US Gold	£24.99	69%
30(-)	<b>New Neuromancer</b>	Electronic Arts	£25.99	81%

Chart compiled by Gallup Ltd © 1991 European Software Publishers Association.



# DEAL DIRECT



# DEAL DIRECT



**SAME DAY DESPATCH**

# AT LAST!!

**ALL PRICES INC V.A.T**

**A PREMIER TRADE SUPPLIER COMES DIRECT TO YOU - THE PUBLIC!**

## 3 1/2" DISKS

Large or small users - we have the prices for you!

### SONY D/S D/D 135 tpi

50's.....42p each	£21.00
100's.....41p each	£41.00
400's.....39p each	£156.00
800's.....36p each	£288.00
1200's.....35p each	£420.00

### MITSUBISHI D/S D/D 135 tpi

50's.....37p	£18.50
100's.....36p	£36.00
400's.....33p	£132.00
800's.....30p	£240.00
1200's.....29p	£348.00

All disks are PIN numbered and carry a 100% quality control/no quibble guarantee. Disk labels supplied

**3 1/2" DISKS FROM 29p inc VAT**

## STORAGE BOXES

3 1/2" (10 capacity box) "Slimpak" see through	£0.95 each
3 1/2" (10 capacity box) "Slimpak"	£0.95 each
3 1/2" (10 capacity box) see through "Vision 10"	£1.00 each
3 1/2" (40 capacity box) lockable disk storage box	£3.50 each
3 1/2" (50 capacity box) lockable disk storage box	£3.95 each
3 1/2" (80 capacity box) lockable disk storage box	£4.30 each
3 1/2" (100 capacity box) lockable disk storage box	£4.95 each
3 1/2" (120 capacity box) lockable disk storage box	£6.50 each
3 1/2" (150 capacity box) lockable and stackable storage box	£24.95 each
3 1/2" 'POSSO' stackable box (holds 150)	£15.95
3 1/2" 'BANX' lockable/stackable (holds 90)	£7.95

All disks boxes are anti-static, Amiga beige, contain keys, dividers and rubber feet (with the exception of 10's)

## ACCESSORIES

Printer Stands (80 col).....	£5.50
Printer Stand with tray (80 col & 132 col).....	£6.95
Tilt 'n' turn monitor stands for Amiga.....	£9.95
Four Player Adaptor.....	£4.95
Data Switches (2-way serial or parallel).....	£15.95
Mouse/Joystick Extension.....	£4.95
A4 Desk Top Holder.....	£7.90
Mousemats (deluxe) red, blue.....	£2.95
Mousemats 5mm packaged.....	£1.95
Mousebrackets.....	£1.95
Amiga printer leads.....	£3.95
3 1/2" cleaning kits.....	£1.95
Amiga Dust Covers.....	£2.95
Amiga Screen Filters.....	£12.95
Roll of 1000 3 1/2" labels.....	£6.95
1000 Tractor feed labels.....	£9.95
Mouse/Joystick Switches manual.....	£9.95
Star LC24 200 dust cover.....	£4.95

## PRINTER RIBBONS

	QTY1	QTY5	QTY10
Amstrad DMP 2000/3000.....	£2.90	£2.60	£2.20
Amstrad DMP 4000.....	£3.90	£3.60	£3.20
Amstrad PCW 8256/8512.....	£3.50	£3.20	£3.00
Amstrad PCW 9512.....	£2.90	£2.60	£2.20
Brother HR15/20/25/35.....	£2.50	£2.30	£2.15
Brother M1009/1109.....	£3.90	£3.60	£3.20
Citizen 120D/LSP10.....	£2.90	£2.70	£2.40
Epson MX/FX80/85/800.....	£2.90	£2.70	£2.40
Epson FX100/105/1000.....	£3.60	£3.40	£3.10
Epson LX80/86.....	£2.90	£2.70	£2.30
Panasonic KXP 1080/81/82.....	£3.90	£3.70	£3.20
Star LC10.....	£2.90	£2.70	£2.40
Star LC10 4 colour.....	£5.90	£5.30	£5.00
Star LC24 200 Mono.....	£3.90	£3.60	£3.20

PLEASE NOTE THAT THIS IS JUST A SMALL SELECTION OF OUR LARGE RANGE. TELEPHONE 0530-813591 FOR PRICING ON OTHER RIBBONS NOT LISTED

## RAM EXPANSIONS

1/2 meg upgrade (without clock).....	£26.95
1/2 meg upgrade (with clock).....	£28.95
1 1/2 meg upgrade (with clock).....	£89.95

Features include: ON/OFF memory switch, auto-recharge battery backed clock.

## SPECIALS

Star LC200 Colour Printer.....	£259.95
Star LC24-200 Colour Printer.....	£279.95
Star LC10 Mono Printer.....	£158.95
Commodore 1084S Monitor.....	£249.95
Philips Colour Monitor.....	£249.95
(ref. CM8833)	
11 x 9 1/2 S.P plain 70 GSM Micro per paper	
Pack 100.....	£2.50
Pack 250.....	£3.95
Pack 500.....	£5.95
Pack 1000.....	£8.95
Pack 2000.....	£16.95

## OMC AMIGA STARTER PACK

COMPRISES:	NO NEED TO SHOP AROUND
Screen Gems	
1/2 meg additional RAM upgrade	R.R.P £679
3 1/2" external disk drive	
10 3 1/2" D/S D/D 135 tpi diskettes	
1 (40 cap) lockable storage box	<b>OMC All inclusive price of £465.00 inc. VAT</b>
1 mousemat	
1 mouse	
1 mouse bracket	A saving of £214.00
1 joystick	
1 Amiga dustcover	
PLUS the usual 4 great software titles	
PHONE FOR DETAILS ON CLASS OF 90's PACK	

## AMIGAS

Screen Gems 1Mb.....	£349.94
Basic Amiga including Modulator and mouse.....	£329.99

## DISK DRIVES

3 1/2" External disk drive for Amiga, Slimline design colour co-ordinated throughport connector. 1 year guarantee

**ONLY £55.95**

## SOUNDBLASTER

ZYFI  
Twin stereo amplified speaker system for the Amiga. Pack includes: cables, built-in power supply, speakers and easy fitting instructions,

**Only £39.95 inc. VAT**

## POWER SUPPLY

Fully compatible replacement Power Supply for Amiga 500

**ONLY £38.95**

## MICE

Amiga mouse, two button fully compatible as replacement.....	£17.90
Naksha mouse inc 2 year warranty, mouse mat & mouse bracket.....	£26.95
Geniscan GS4000 Amiga Scanner.....	£159.95

## JOYSTICKS

Quickshot II Turbo.....	£7.95
Quickshot III Turbo.....	£8.50
Quickshot III Turbo Microswitch.....	£8.99
Quickshot Maverick.....	£11.99
Quickshot Maverick Microswitch.....	£12.99
Quickshot Starfighter Infra Red.....	£29.99
Quickshot Apache.....	£6.50
Zipstick Autofire.....	£10.99
Plus many more stocked	

## TO ORDER

CHEQUES AND P.O.'S PAYABLE TO OMC LTD AND SEND TO ADDRESS BELOW.  
CREDIT CARDS SIMPLY TELEPHONE YOUR ORDER ON 0530 813591 (8 LINES) or 0860 922436 (mobile)  
FAX 0530 813595 FOR OUR IMMEDIATE ATTENTION

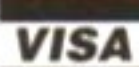

**THE ORIGINAL MEDIA COMPANY LTD  
DEPT AF, MEDIA HOUSE, UNIT 14, ASHBY ROAD,  
COALVILLE, LEICS LE6 2LA**

TEL 0530 813591(8 lines) or 0860 922436 (mobile) FAX: 0530 813595

Trade a/cs welcome. All prices include VAT. Corporate, education orders welcome.



**DELIVERY COSTS**

3-5 day TNT  
£3.95

Next day Carrier  
£8.95

# DEAL DIRECT

# DEAL DIRECT



**NOW** – from the makers of Amiga Format

# MOUNTAIN BIKING UK

the magazine that does for mountain biking what Format does for the Amiga

## Every issue contains:

- Bike tests – Britain's definitive reviews
- The latest equipment
- Racing news – big competitions at home and abroad
- Touring – what you need, where to go, how to get there
- Riding techniques
- Maintaining your machine

And a whole load more!

**PLUS** – In the current issue – WIN A RALEIGH ODYSSEY IN OUR £1,000+ COMPETITION!



## From some of the top names in the industry\*

PAUL HINTON – Raleigh team pro, mountain bike journo of the year

STEVE WORLAND – one of the dudes from Pace Research, the hottest UK bike manufacturer.

BRANT RICHARDS – MTB tech expert – all you need to know about how a mountain bike works (what do you mean it's just a bike?)

BRIAN HEMSWORTH – the man who knows everything there is to know about riding an emteebee (you don't just get on and pedal!)

\* and it's just possible Paul 'I ride a mountain bike' Lyons will end up writing for us as well (but we're trying to discourage him...)

AND Check out our amazing subscription offer – six quid's worth of free lube! (to use on your MTB, not your Amiga)

**MBUK**  
Britain's best selling  
monthly bike mag!  
At your newsagents  
**NOW!**

**UNIQUE 3 PLAYER RACING ACTION!**

# **WIN THIS INDY HEAT MACHINE!**

"INDY HEAT"  
HAS TO BE THE MOST  
INCREDIBLE DRIVING ARCADE  
MACHINE IN THE WORLD! IT GIVES  
3 PEOPLE THE CHANCE TO RACE EACH  
OTHER, AS EACH PLAYER HAS THEIR OWN  
STEERING WHEEL AND FOOT PEDAL TO DRIVE  
THEIR OWN CAR! PLUS THERE ARE 14 GREAT  
RACE COURSES ON WHICH YOU CAN TAKE UP  
THE CHALLENGE AND GO FOR THAT RADICAL  
RACING ACTION! BUT THE BEST THING ABOUT  
THIS PARTICULAR INDY HEAT MACHINE IS THAT  
WE'RE GIVING IT AWAY! YUP, THE WINNER OF  
THIS COMPETITION WILL GET TO HAVE THIS IN  
THEIR HOME - SO YOU CAN PLAY IT AS OFTEN  
AS YOU LIKE WITHOUT PUTTING A PENNY IN  
THE SLOT! SOUNDS GOOD? THEN CALL...

**0898 404609**



## **PLUS! WIN THIS HONDA RADIO CONTROL MOTORCYCLE!**

THIS HONDA G-CON BIKE IS READY TO RUN THE  
MINUTE YOU OPEN UP THE BOX! THE 1/5 SCALE  
MODEL IS SO REALISTIC THAT WHEN YOU TAKE  
CONTROL YOU CAN REALLY EXPERIENCE  
WHAT IT'S LIKE TO RIDE A REAL SUPERBIKE!!

**0898 404607**



Calls cost 34p (cheap rate) and 45p (at all other times) per minute incl VAT. For details of winners send SAE to:  
Populuxe, PO Box 2065, London, W12 9JH. Average length of call is 5.5 minutes. 0898 calls are more expensive than  
normal calls so please ask permission to call if you don't pay the bill.

# Be the coolest hitter or catcher in the country with some real sound baseball kit, courtesy of Domark and RBI2!

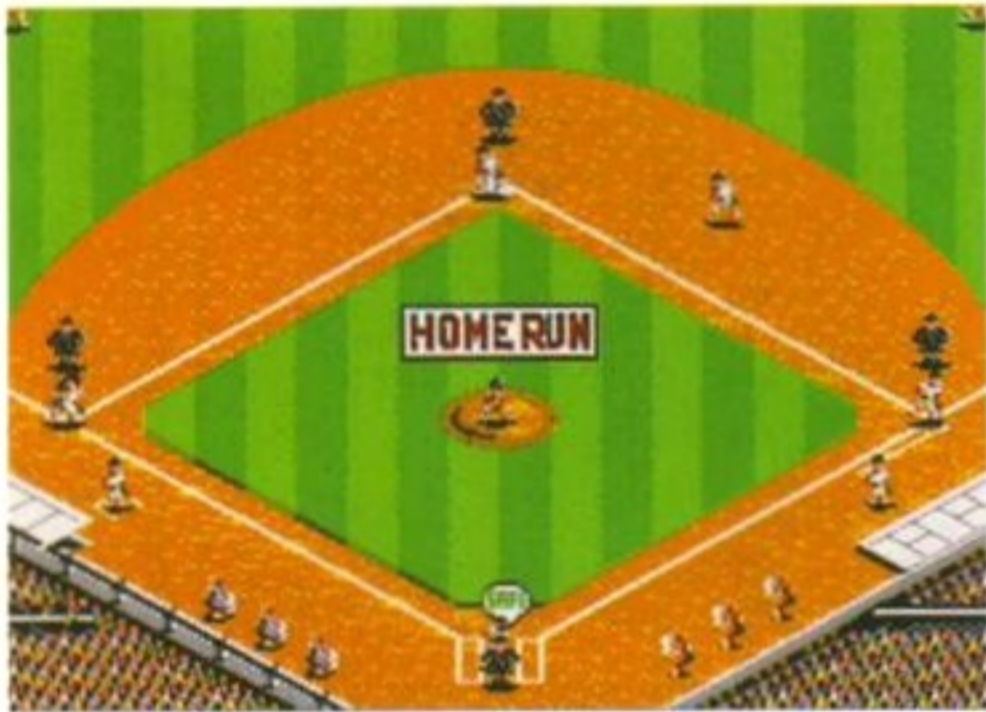

## THE LOW-DOWN

You may have got yourself a copy of *RBI2*, Domark's excellent baseball game which scored a cracking 84 per cent in the last issue. You may have had hours of fun playing it, going for those home runs and striking out the opposition's hitters. But it being summer an' all, why the heck not get out there in the park or your mate's back garden and have a go at the real thing? Catch some fresh air and sunshine (likely story!) and catch a few balls at the same time!

If you don't have the baseball kit and your finances won't stretch to the necessary readies, then what you need to do is win yourself a compo prize... oh, and here come a few now! How handy!

We've got five sets of kit ready and waiting. Each one contains a ludicrously colourful fluorescent baseball bat, a ball and a special RBI 2 baseball hat just to put you in the mood. But best of all, the overall winner will also get an extremely expensive leather catcher's mitt and a unique limited edition RBI 2 baseball jacket. You can't buy those, you know!

## THE QUESTIONS

**1** What famous cartoon character always loses at baseball?

- a Calvin
- b Mickey Mouse
- c Charlie Brown

**2** What famous cartoon character plays baseball with his tiger?

- a Mickey Mouse
- b Charlie Brown
- c Calvin

**3** Which famous cartoon character doesn't really play baseball terribly often at all, really?

- a Calvin
- b Charlie Brown
- c Mickey Mouse

## THE WAY TO WIN

So all you have to do to win this mega-simple compo, and get all this really lush kit, is write down the answers to the three easy questions that are on your left on the back of a stuck-down envelope or a post-card for that matter, along with your name and address. Then stick a stamp on it and whack it in the post to: Dead Easy Baseball Compo, *Amiga Format*, 29 Monmouth Street, Bath Avon BA1 2BW. All entries must reach our office by September 13 at the very latest. You should get your baseball bat just in time for the last days of summer...

## THE RULES

All employees of Future Publishing or Domark are not allowed to enter. The judges decision in all matters is final and no correspondence will be entered into in connection with this competition.

No entries from members of the New York Mets or people whose middle name is Elephant, you know who I am talking about!

New Showroom  
232 Tottenham Court Road  
London W1

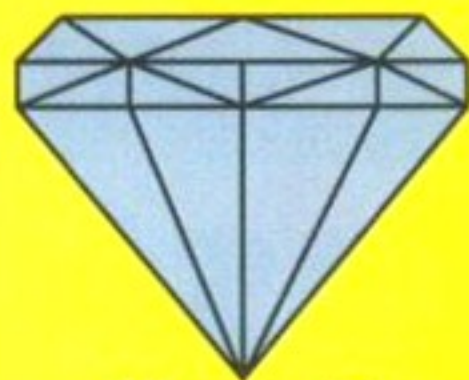

New Showroom  
232 Tottenham Court Road  
London W1

# DIAMOND

## COMPUTER SYSTEMS LTD

1Mb **PACK** 1Mb  
COMMODORE  
CARTOON CLASSIC PACK

AMIGA 500 +  
Lemmings, Captain Planet  
Bart Simpson, Deluxe Paint III  
+ RAM board

ONLY **£359.00**

**Extras 10 Games**  
Man United, Total Recall, Speed Ball II,  
Xenon II, Teenage Mutant Ninja Turtles,  
Final Battle, Stunt Car Racer, Golden Axe,  
Cadaver, Super Off-Road Racer, joystick,  
mouse, mousemat, dustcover,  
ten spare disks + box

ONLY **£399.00** INC VAT  
WITH  
8833 MK II Colour Monitor  
ONLY **£569.00**

LIMITED STOCK

1Mb **PACK** 1Mb  
CLASS  
OF  
90's PACK

Everything you need for  
Art + Design + Word Processing

AMIGA 500 +  
AMIGA LOGO, INFOFILE, LETSPELL,  
MUSIC MOUSE, CBM EMULATOR,  
DELUXE PAINT II, D501 1/2 Meg  
upgrade, Mouse Mat + 10 free disks

ONLY **£459.00** INC VAT

LIMITED STOCK

1Mb **PACK** 1Mb  
AMIGA 500 MEGA PACK  
INCORPORATING  
AMIGA 500 +

- \* 512K RAM
- \* 1Mb Disk Drive
- \* 4096 Colours
- \* Mouse
- \* Extra 512k RAM with Clock
- \* Three Manuals
- \* Operating System
- \* Built-in Speech
- \* T.V. Modulator

ONLY **£339.00**

WITH  
8833 MK II Colour Monitor  
ONLY **£549.00**

LIMITED STOCK

**PACK**  
THE BEST OF  
PUBLIC  
DOMAIN

THE 24 CARAT  
DIAMOND P.D. PACK

AMIGA 500 +

The best 24 Titles available  
in P.D. software including

Skill games, Fantasy games,  
Word Processing, Amazing Graphic Demos,  
and Electrifying Art Pack + many more  
too numerous to mention

ONLY **£325.00**

LIMITED STOCK

**NEW PACK NEW**

AMIGA 500 SpeedBall PACK  
INCORPORATING

- \* 512K RAM
- \* 1Mb Disk Drive
- \* 4096 Colours
- \* Mouse
- \* T.V. Modulator
- \* Three Manuals
- \* Operating System
- \* Built-in Speech  
Synthesis

\* MEGA PACK \*  
Speed Ball II, Total Recall, Man United  
Xenon II, Teenage Mutant Ninja Turtles,  
Final Battle, Stunt Car Racer, Golden Axe,  
Cadaver, Super Off-Road Racer

ONLY **£349.00**  
WITH  
8833 MK II Colour Monitor  
ONLY **£549.00**

LIMITED STOCK

**PACK**  
ONLY WHILE STOCKS LAST

AMIGA 500 AXE PACK  
INCORPORATING

- \* 512K RAM
- \* 1Mb Disk Drive
- \* 4096 Colours
- \* Mouse
- \* T.V. Modulator
- \* Three Manuals
- \* Operating System
- \* Built-in Speech  
Synthesis

\* 10 GAMES \*  
Golden Axe, Hard Drivin', Phobia,  
Saint & Greavsie, Silk Worm,  
Datastorm, Continental Circus,  
Turrican, Ninja Warriors  
Emotion

ONLY **£349.00**  
WITH  
8833 MK II Colour Monitor  
ONLY **£549.00**

LIMITED STOCK

### The adventures of CAPTAIN DIAMOND



NEXT MONTH IN COLOUR: MEET CAPTAIN DIAMOND AS HE DEFENDS THE TOTTENHAM COURT ROAD MEGASTORE!!

No. 1  
FOR

Diamond Retail Outlets Around The United Kingdom

No. 1  
FOR



- Dorset  
☎ 0202 716226
- Bristol  
☎ 0272 522044
- Manchester  
☎ 061 257 3999
- Warks  
☎ 0962 312155



- Southampton  
☎ 0703 232777
- Romford  
☎ 081 597 8851
- Edinburgh  
☎ 031 554 3557
- Central London  
☎ 071 453 0434



Export Hotline Bristol  
0272 522044  
Richard Brown

REMEMBER,  
AT DIAMOND YOU HAVE A CHOICE

Authorised full service centre at our Bristol Office,  
now offering same day repairs. Contact Keith our  
service manager for details Bristol 0272 522044

**NEW PACK NEW**  
AMIGA 500 SKILL PACK  
INCORPORATING  
AMIGA 500 +

- \* Disk Storage Box
- \* 1Mb Disk Drive
- \* 4096 Colours
- \* Mouse
- \* T.V. Modulator
- \* Dust Cover
- \* 10 3.5" Disks
- \* Three Manuals
- \* Operating System
- \* Built-in Speech Synthesis
- \* **EXTRA 512k RAM**
- \* Mouse Mat
- \* Dpaint II

\*DIAMOND MEGA 10 GAMES\*  
Man United, Total Recall, Speed Ball II, Xenon II, Teenage Mutant Ninja Turtles, Final Battle, Stunt Car Racer, Golden Axe, Cadaver, Super Off-Road Racer + Joystick

ONLY **£369.00**  
WITH  
8833 MK II Colour Monitor  
ONLY **£579.00**

**LIMITED STOCK**

**PACK**  
AMIGA 500 NINJA PACK  
INCORPORATING  
AMIGA 500 +

- \* Disk Storage Box
- \* 1Mb Disk Drive
- \* 4096 Colours
- \* Mouse
- \* T.V. Modulator
- \* Dust Cover
- \* 10 3.5" Disks
- \* Three Manuals
- \* Operating System
- \* Built-in Speech Synthesis
- \* **EXTRA 512k RAM**
- \* Mouse Mat
- \* Dpaint II

\*DIAMOND MEGA 10 GAMES\*  
Golden Axe, Hard Diskin, Phobia, North & South, Silk Worm, Datastorm, Continental Circus, Turrican, Emotion, Ninja Warriors + Joystick

ONLY **£369.00**  
WITH  
8833 MK II Colour Monitor  
ONLY **£579.00**

**9 PIN QUALITY** **PACK** **Word Processor & DTP**  
AMIGA 500

- \* 512K RAM board
- \* Philips 8833 Mk II Monitor
- \* SWIFT 9 Colour
- \* Connecting Lead

**PLUS HOME OFFICE**  
*The ultimate word processor/DTP pack*

- \* Intergrated Word Processor
- \* DTP
- \* Spreadsheet
- \* Database

ONLY **£775.00**

**24 PIN QUALITY COLOUR** **PACK** **THE ULTIMATE**  
AMIGA 500 **PACK**

**PLUS HOME OFFICE**  
*The ultimate word processor/DTP pack*

- \* Integrated Wordprocessor
- \* DTP
- \* Spreadsheet
- \* Database

**PLUS**  
24 pin SWIFT 24 colour printer  
Including colour kit  
**PLUS**  
512K RAM Board  
Philips 8832 Mk II Monitor  
**£899.00**

**PACK**  
A590  
20Mb Hard Disk with 2Mb RAM

- \* 20 FREE 3 1/2" disks
- \* 80 Disk Capacity, Disk Box

ONLY **£339.50**

A590 20Mb Hard Disk

0Mb RAM **£279.00** 512K RAM **£299.00**  
1Mb RAM **£319.00** 2Mb RAM **£339.00**

**IVS TRUMPCARD**

D590 40Mb Hard Disk

0Mb RAM **£399.00** 2Mb RAM **£499.00**  
4Mb RAM **£622.00** 6Mb RAM **£739.00**  
8Mb RAM **£939.00**

**PACK**  
DIAMOND  
MUSIC MASTERS PACK

Everything you need  
to create your own  
in house musical extravaganza

AMIGA 500  
+ MUSIC-X  
( the complete MIDI sequencer  
as used in recording studios  
by the professionals)  
+ MIDI interface  
+512k RAM upgrade

ONLY **£399.00** INC VAT

IF ONLY WE COULD CAPTURE THE PRICE  
PLEDGE FROM DIAMOND... THEN  
NOTHING WOULD STAND IN OUR WAY!!



THERE'S ONLY ONE MAN WHO CAN  
HELP... THE KEEPER OF THE  
PRICE PLEDGE ...  
CAPTAIN DIAMOND!!



If, whilst buying goods from us, you can show us a  
better price for the same goods from one of our U.K.  
competitors then DIAMOND will match that price.

Even if our prices have increased we will honour the  
prices in this advertisement on items in stock as long as  
you bring it with you.

This Pledge applies only to customers producing or  
relying on this advertisement before the end of the  
month of publication. It does not apply to competitors  
prices offered in closing down or stock clearance sales.



**WANT A1500?  
GOT A 500?**

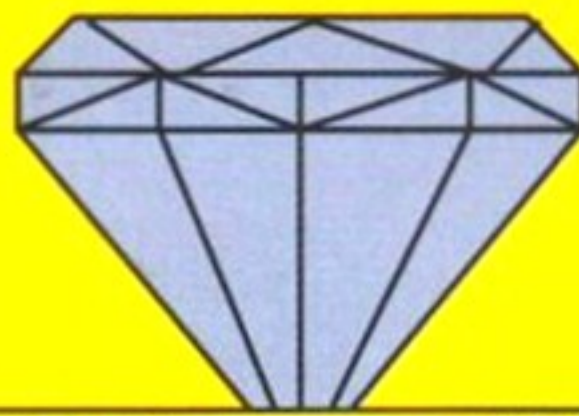

**SWAP IT  
FOR ONLY  
£499.00**



# MR DIAMOND'S PART EXCHANGE CENTRE



## Mr DIAMOND'S WORLD OF AMIGA COMPARISONS



- A500 = A Ford XR3 Fun for a while, looks great but lacks any real power compared with higher spec models.
- A1500/2000 rev B = A Mercedes Designed for high performance and reliability
- A3000 = A Ferrari Quite simply the ultimate

Now you understand the machines, you can improve your social standing with a great part exchange deal from Mr Diamond.

**Don't you owe it to yourself to drive the best?  
Well now you can, with DIAMOND P/X**

**P/X now available at all branches  
throughout the U.K.**



**AMIGA 1500**

A 1500 1Mb RAM, 3.5" floppy disk drive, base machine with 2x 3.5" floppy disks and software pack **£699.00**

**all above + Monitor £899.00**

**with XT Bridgeboard £999.00**

**INCREDIBLE PX OFFER**  
visit Mr. Diamond and discover what your A500 is worth in part exchange

XT Bridgeboard 5.25" floppy drive **£149.00**

AT Bridgeboard with either 3.5" or 5.25" floppy drive **£575.00**

**AMIGA 3000**

The **NEW** Commodore AMIGA

AMIGA 3000-25-100 25Mhz, 100Mb hard disk  
An Incredible **£2395.00** INC

Mr Diamond Incredible Offer with 1950 M/sync monitor **£2595.00** INC

AMIGA 3000 4Mb RAM expansion **£349.00**

This machine is a veritable workstation; it comes with Workbench 2.0 - The new Commodore Multi-tasking Operating System - It can run the normal video monitor or a multisync monitor without having to fit a flicker fixer. It can even run under UNIX. This is the machine to set the standard for professional use in the 1990's.

**AMIGA 2000**

If you have reached the limits of the A500 then take advantage of the **Diamond Part Exchange Upgrade Option**. Swap your 1Mb A500 for an A2000 for **ONLY £349.00**

**Mr. DIAMOND AMIGA 2000 PACK**  
A2000 Rev. B 48Mb Autobooting Hard Disk, 28ms average access **ONLY £995.00**  
With Colour Stereo Monitor **ONLY £1195.00**

A2000 base machine **£469.00**  
Ex-demo A2000 **£645.00**

**PC XT & AT Compatibility for AMIGA**  
XT Bridgeboard 5.25" floppy drive **£149.00**  
AT Bridgeboard with either 3.5" or 5.25" floppy drive **£575.00**



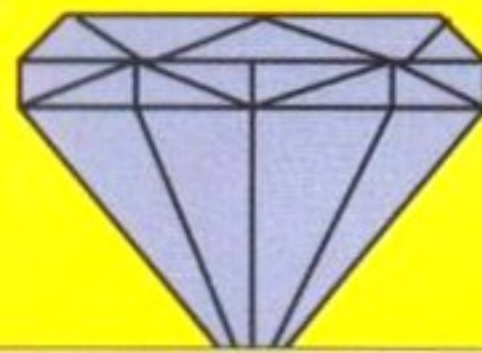

# MR DIAMOND'S SUPER SPARES CENTRE

## IVS TRUMPCARDS

The IVS Trumpcard is the top selling SCSI hard drive controller. Representing the latest in technology directly from the USA, it is the only controller to support IBM, Amiga and Apple MAC partitions on one hard disk. This allows you to run software for the three main hardware platforms on one machine. Only one computer can do this.

## HARD DISK DRIVES

### IMPULSE

IMP52S/LP	52Mb 9ms	£229.00
IMP80S/LP	80Mb 9ms	£369.00
IMP105S/LP	105Mb 9ms	£399.00
IMP170S	170Mb 8ms	£599.00
IMP210S	210Mb 8ms	£659.00

### FUJITSU

M2612ESA-MJ	90Mb 19ms	£379.00
M2613ESA-MJ	135Mb 19ms	£379.00
M2614ESA-MJ	180Mb 19ms	£379.00

### SYQUEST

44Mb 28ms P.O.A. removeable cartridge drive

TRUMPCARD FOR ABOVE add £115.00

## PHILIPS MONITOR

8833 MkII colour monitor  
inc. dust cover and lead

only **£234.00**

## EXTERNAL DRIVE

3.5" external drive **£54.95**

## FLICKER FIXER

Get those flicker free high res modes,  
use the Flicker Fixer Video Card

**£299.00**

## MEMORY UPGRADES

for your A1500 or A2000 with the  
Supra 8Mb RAM board

Bare Board	£81.00
2Mb populated	£75.00
4Mb populated	£149.00
6Mb populated	£223.00
8Mb populated	£295.00

## HIGH RES

1024x768, 0.28 dot pitch

Multisync Monitor **£349.00**

## GVP PRODUCTS

GVP COMBO board. The SCSI hard disk controller with built in 68030 accelerator and RAM expansion capability.

22MHz Combo with 1Mb RAM	£799.00
33MHz Combo with 41Mb RAM	£1495.00
40 Mb SCSI hard disk	£249.00
114 Mb SCSI hard disk	£449.00

GVP Series 2 RAM Card comes with 2Mb RAM as standard.  
2Mb **£200.00** 4Mb **£275.00** 8Mb **£345.00**

GVP Series 2 RAM Card	
Bareboard	£209.00
40Mb	£369.00
52Mb Quantum 11ms	£429.00
114Mb NEC 20ms	£549.00

## SPEED UP

your 1500, 2000  
with a  
Co-Processor  
board.  
Phone for  
details

## SOFTWARE

Pro Page 2.0	£169.95	Pro Video Post	£149.00
Propage Templates	£34.95	Propage ClipArt	£34.95
Pro Write	£85.00	Sculpt Animate 4D	£279.00
Broadcast Titler II	£179.00	X CAD Designer	£69.33
X CAD professional	£229.00	Deluxe Paint III	£34.95
Digiview Gold 4	£88.13	Pixmate	£35.00
Vista	£49.00	Distant Suns	£36.00
Pen Pal	£81.00	Cross DOS	£25.00
Devpac Amiga	£45.00	Hisoft BASIC	£55.00
Lattice C V5.0	£149.00	Lattice C++	£250.00
Hisoft Pro Flight	£34.00	Pro Draw	£81.00
Quarter Back	£35.00	Videotitler	£100.00
Turbo Silver	£100.00	Director 2.0	P.O.A
Photon Paint II	£23.50	Bars & Pipes	£120.00
Excellence	£89.95	Pagesetter 2.0	£44.95
Pagestream 2.1	£129.95	Pro Write 3.1	£89.95
Quick Write	£34.95	Scribble Platinum	£34.95
Transwrite	£27.95	Platinum Works	£69.95
Home Office Kit	£69.95	Superbase Pro 4	£116.50
Hyperbook	£34.95	Wordworth	£85.00

ICD Adspeed	£175.00	ICD Flicker Free video	£250.00
ICD FFF & VGA Monitor	£499.00	KCS PC Power board	£235.00
AT-Once	£169.00		
(2000 version also available)	£199.00		

ICD  
FLICKER FIXER  
£Lots.00

600 Mb  
Hard Disk  
£Lots.00

Tape Streamer  
£Lots.00

20Mb Floppy  
drive  
£Lots.00

## NEXUS COMBO'S

High speed Hard Disk Controllers taking  
up to 8Mb of on board RAM

Bareboard	£229.00
40Mb	£389.00
52Mb Quantum 11ms	£449.00
114Mb NEC 20ms	£559.00

## GENLOCKS

Rendale	£149.00
G2	£575.00

Obviously, when you carry as much stock as  
DIAMOND, you can't advertise all your spares;  
but contact your local branch and we guarantee  
you won't find the part that you're looking for at  
a better price.



THE VISION OF THE FUTURE IS NOW THE PRESENT  
AT DIAMOND

## C.D.T.V. £599.00

EDUCATE YOUR CHILDREN THE WAY THEY WANT TO BE EDUCATED, WHILST BEING THE ENVY OF ALL YOUR FRIENDS, WITH A NEW DIMENSION IN SOUND AND GRAPHICS FOR YOUR HOME.

So what is C.D.T.V. ? Are you confused by all the hype?

If you are , then why not pop into your local Diamond branch for a full working demonstration of this exciting new medium and have all the answers to all of your questions translated by experts from unnecessary gobledgook into plain easy to understand English.

### GREAT PART EXCHANGE OFFERS

You will be surprised at just how generous Mr Diamond will be when yo trade in your old Amiga 500 for a C.D.T.V.  
C.D.T.V. ROM, normally £599.00, only £349.00 when you P/X your old Amiga 500  
External Amiga A500 ROM Player ONLY £399.00

#### ENTERTAINMENT

All Dogs Go To Heaven, Electric Crayon	£34.99
Classic Board Games	£34.99
Psycho Killer	£29.99
Wrath of the Demon	£29.99
Case of the Cautious Condor	£34.99
Battlestorm	£29.99
Sim City	£29.99
Defender of the Crown	£29.99
Lemmings	£34.99
Xenon II : Megablast	£29.99
Indoor Sports	£29.99
Many Roads to Murder	£29.99
Snoopy	£29.99
Spirit of Excalibur	£34.99
Horse Racing	£29.99
Ninja Highschool Comix	£16.99
Dinosaurs for Hire	£16.99
Basketball	£29.99
Battlechess	£44.99

#### REFERENCE

Hutchinsons Encyclopeadia	£49.99
Time Table of Science & Innovation	£39.99
Time Table of Business Politics	£39.99
Dr. Wellman	£54.99
The New Basics Electric Cook Book	£39.99
World Vista Atlas	£54.99
American Heritage Dictionary	£49.99
Complete Works of Shakespeare	£34.99
Illustrated Holy Bible	£34.99

#### EDUCATION

Barney Bear Goes to School	£34.99
Fun School 3 (for under 5's)	£29.99
My Paint	£24.99
A Bun for Barney	£29.99
Mind Run	29.99
Thomas's Snowsuit	£34.99
Scary Poems for Rotten Kids	£39.99
Paper Bag Princess	£34.99
The Tales of Peter Rabbit	£39.99
Mud Puddle	£34.99
LTV English	£34.99

#### ART & LEISURE

Indoor Plants	£29.99
Women In Motion	£34.99
Animated Colouring Book	£34.99
Advance Military Systems Series	£29.99
Garden Plants	£34.99
Trees and Shrubs	£34.99
Fruits , Vegetables and Herbs	£34.99

#### MUSIC

Music Maker	£19.99
-------------	--------

## SOFTWARE SUPERSALE

EVERY DAY IS SALES DAY WHEN YOU SHOP THE DIAMOND WAY  
ALL THESE TOP TITLES FOR ONLY A REDICULOUS £5.00

Man United, Totall Recall, Speed Ball II, Xenon II, Teenage Mutant Ninja Turtles, Final Battle, Stunt Car Racer, Cadava, Super Off Road Racer, Golden Axe, Hard Drivin', Phobia, North & South, Silkworm, Shockwave, Continental Circus, Turrigan, X-Out, Ninja Warriors, Table Tennis, Chess Player 2150, Datastorm, E-Motion, Dungeon Quest, Grand Master Slam, Kid Gloves, Mercenary, Rick Dangerous, RVF Honda, Shufflepuck Cafe, Soccer, Menace, Blood Money, Saint & Greavsie, Netherworld, Nightbreed, Slaygon, Snowball Hell, Fastlane, Aton 500, Balistrix, Gold Runner, Tower of Babel, Fantasy World of Dizzy, Star Blaze, ,star Ray, Terra Quester, Jupiter Probe, Bombuzzal, Days of Thunder, Dark Castle, Dark Side, Prospector, Archepelagos, Terrorpods and many many more...

ONLY SOMEONE AS WONDERFUL AS MR DIAMOND CAN OFFER YOU THE LATEST TOP SELLING TITLES AT  
UP TO 1/2 PRICE, JUST CHECK THE PRICES

Lemmings only £14.95, Bart Simpson only £9.95, Captain Planet only £9.95, Deluxe Paint III only £34.95

D501 512k RAM card + clock  
ONLY £29.95

ALL PRICES  
INCLUDE  
VAT



ALL PRICES  
INCLUDE  
VAT

D501 512k RAM card +  
Disk Drive ONLY £81.00

### CHIPS & DISKS

We only sell new chips

A590 Memory chips

0.5Mb £17.60

1.0Mb £35.25

2.0Mb £69.00

A590 2Mb Populated £328.00

#### 8UP BOARD & CHIPS

Bare Board (0Mb) £81.00

add cost of RAM to your

specification

2Mb +£69.00

4Mb +£137.50

6Mb +£206.00

8Mb +£274.00

#### DISK CONTROLLER CARDS

The GRANDSLAM, new SCSI controller from IVS. Extra Parallel port - space for 8Mb on board RAM

ONLY £235.00

NEXUS SCSI hard disk controller card - space for 8Mb on board RAM.

ONLY £199.00

The U.K. official importer

### MONITORS

ALL PHILIPS U.K. MONITORS

HAVE 1 YEAR ON SITE

GUARANTEE



PHILIPS 8833(U.K.)

Colour Monitor with stereo sound

+ FREE LEAD & DUST COVER

Only £229.00

+F19 competition £245.00

DIAMOND Multisync Monitor

Only £347.00

COMMODORE 1084/s

Only £222.00

COMMODORE 1084/SD Monitor

Only £234.00

### DISKS

FOR A LIMITED PERIOD WE ARE

SELLING HIGH QUALITY 3.5" SONY

BULK DISKS AT ONLY £0.35 EACH

### PRINTERS & RIBBONS

STAR LC200 COLOUR £189.00

CITIZEN 124D £190.00

OKIDATA LASER 400 £704.00

PHILIPS MNS 1432 £116.00

CITIZEN SWIFT 24 P.O.A.

WITH COLOUR P.O.A.

PANASONIC KXP/1123 £187.00

OKIMATE 20 £153.00

STAR LC MONO £140.00

STAR LC/24/10 P.O.A.

#### RIBBONS

OKI 20 COLOUR £4.95

OKI 20 BLACK £4.95

PANASONIC KXP/1124 £4.95

KXP1080/1/2/3 £4.95

JUKI 6100 £4.95

M.TALLY MT80 £4.95

STAR LC10 £4.95

STAR LC10 COLOUR £4.95

STAR LC24/10 £4.95

EPSON LX800 £4.95

AMSTRAD PMP4000 £4.95

## VIDEO SECTION

Deluxe Paint III	£34.95	DigiView Gold 4.0	£88.13	Deluxe Video III	£67.95
Digipaint III	£54.75	Rombo Vidi	£81.00	Amiga Vision	£69.95
Photon Paint II	£23.50	Disney Animation		Art Department	£49.95
Spritz	£3.50	Studio	£82.25	Art Dept Pro	£124.95
Icon Paint	£3.50			Art Dept Pro	
Comic Setter	£23.50	Video Studio	£116.50	conversion Kit	£59.95
Can Do	£89.95	Can Dot Pro Pack	£24.95	Deluxe PhotoLab	£49.95
Elan Performer 2	£74.95	Hyperbook	£39.95	Scala	£169.95
Scene Generator	£27.95	T.V. Show	£48.95		

## AUDIO MUSIC AUDIO

All the latest and best audio and music packages from Mr. Diamond at the keenest prices

MusicX ver 1.1	£59.00
Perfect Sound	£39.00
Audio Engineer	£149.00
MasterSound	£25.00
Quartet	£33.00
MIDI I/F	£26.00
Keyboard	£25.00



LHC Microsales  
121 Regents Street  
Leamington Spa - Warks  
TEL 0926 312155  
FAX 0926 883432

▼ OPEN ON SUNDAYS ▼



Diamond Computers  
144 Ferry Road  
Edinburgh  
Scotland  
TEL 031 554 3557

▲ OPEN ON SUNDAYS ▲



Diamond Computers  
1022 Stockport Road  
Manchester  
TEL 061 257 3999  
FAX 061 257 3997



Diamond Computers  
232 Tottenham Ct Rd  
London, W1  
TEL 071 453 0434  
Amiga World downstairs

## HOW TO ORDER

Simply telephone through your order, giving your Access or Visa card Number or send a cheque or postal order to your Local Dealer.

All prices include VAT unless otherwise stated.

Next Day Courier Service Delivery £11.75

Please allow 5 working days for cheque clearance.

Bankers drafts clear on the same day

All prices are correct at time of going to press but may change without notice.

## THE DIAMOND PRICE PLEDGE

*If, whilst buying goods from us, you can show us a better price on the same goods from one of our U.K. competitors then Diamond will match that price.*

*Even if our prices have increased, we will honour the prices in this advertisement on items in stock as long as you bring it with you.*

*This PLEDGE applies only to customers producing or relying on this advertisement before the end of the month of publication.*

*It does not apply to competitors prices offered in closing down or stock clearance sales*



Diamond Computers Ltd  
84 Lodge Road  
SOUTHAMPTON  
TEL 0703 232777  
FAX 0703 232679



Diamond Computers Ltd  
406 Ashly Road  
POOLE - Dorset  
TEL 0202 716226  
FAX



Diamond Computers Ltd  
227 Filton Avenue  
Bristol  
TEL 0272 693545  
FAX 0272 693223



LAN Computer Systems  
1045 High Road  
Chadwell Heath -  
Romford  
TEL 081 597 8851  
FAX 081 590 8959

# GASTEINER

Tel: +44 081-365 1151

Fax: +44 081-885 1953

Trade and Educational  
Orders Welcome

Technologies

Credit Cards  
Welcome



Personal Callers  
Welcome

## Outstanding NEW products from Gasteiner Technologies

### MEMORY MASTER



A half-length FastRAMN expansion with 4 MBIT technology upgradeable 2, 4, 6 & 8Mb. No additional Wait State in the Amiga 1500/2000 16 Bit-Bus-Technology. Includes RAMtest program and detailed manual.

### PRO-MONITORS

NEC 3D	£499
QUADRA II 1480	£399
PHILIPS 8833	£229

### ALF 3



High speed excellent performance. Hard disk delivered ready for use after plugging into a free A2000-Slot. Optional data transfer independent from processor & uses fully the Amiga-busbandwidth (16 Bit).

### OKTAGON 500



A really intelligent SCSI controller for the Amiga 500.

- Autoboot by FFS
- Automatic reading from SCSI devices
- Supports up to 7 SCSI devices
- Multi tasking capable
- Login and password security

ALL THIS FOR ONLY → **£249**

**GASTEINER** Unit 12 a Millmead Business Centre, Millmead Road, London N17 9QU

### THE TRACK BALL



Switchable between Atari/Amiga with the third button 'Click & Hold' feature this must be the best value trackball at only

→ **£29.95**

### ALFA DATA MOUSE



Best replacement mouse which includes a mouse holder & cutting pad.

For Only → **£16.95**

### UK'S LEADING TOP SELLING SCANNER



Outstanding quality, excellent value - this package includes a 100-400dpi scanner with dither options, plus the amazingly powerful TOUCH-UP software package which drives the scanner directly. Scanner includes viewing window & backlight for accurate scans. Scan either line-art or grey images up to 400dpi.

→ **£149.00**

### GOLDEN IMAGE RC 2000 = 2Mb-8Mb

Populated for A1500 - A2000

2Mb	→	<b>£149</b>
4Mb	→	<b>£219</b>
6Mb	→	<b>£POA</b>
8Mb	→	<b>£POA</b>

### GOLDEN IMAGE OPTICAL MOUSE



Amazing accuracy and reliability with the first optical mouse for the Amiga + ST

### ALFA DATA TRACKBALL



Alfa Data Trackball. Excellent high performance trackball for Amiga and Atari ST. Operates from mouse or joystick port. Top quality construction and opto-mechanical design.

only for → **£24.95**

### 2Mb RAM CARD



- Fully populated board
- Plugs into trap door expansion
- and connects to gray chip. Populated RAM board with click

→ **£34.95**

Ram card 1/2 Mb → **£59**

Ram Card 2Mb → **£99**

### 512K RAM/CLOCK CARD

- 100% A500 compatible
- Battery Back-up Read time Clock on Board
- Support ON/OFF Switch to enable/disable expanded RAM.

Only → **£29.95**

**Packed**

with Amiga  
reviews,  
reviews  
news,  
tips and  
more!

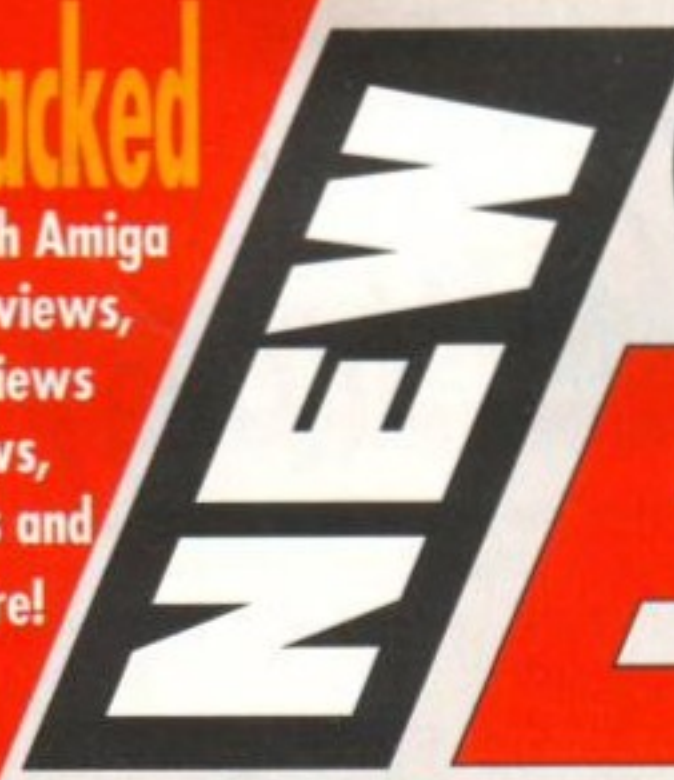

# COMPUTER **EXPRESS**

FIRST NEWS • FIRST REVIEWS • BEST BUYS • YOUR WEEKLY GUIDE

**EVERY  
WEEK**

**GARY PENN**

Every Thursday the  
game's industry's  
most respected  
writer (it says here)  
reports on the fast-  
moving games scene  
— previews, reviews,  
news and tips!

# AMIGA

# NEWS

# SENSATION!



**EXPRESS: it's Amiga Format's weekly  
companion — packed with Amiga stuff**

**PLUS**

**YOUR WEEKLY**

**AMIGA FORMAT'S  
WEEKLY COMPANION —  
LATEST PACKED ISSUE  
OUT THIS THURSDAY!**

Amiga previews,  
reviews — and all  
the best prices!  
■ PD round-ups, techie  
twiddly-type pages,  
readers' letters,  
competitions and, er...  
much, much more!

companion  
out every Thursday,  
all year round  
● It's 68 pages of  
steaming good value!  
● You get change out  
of a quid (12p, in fact)

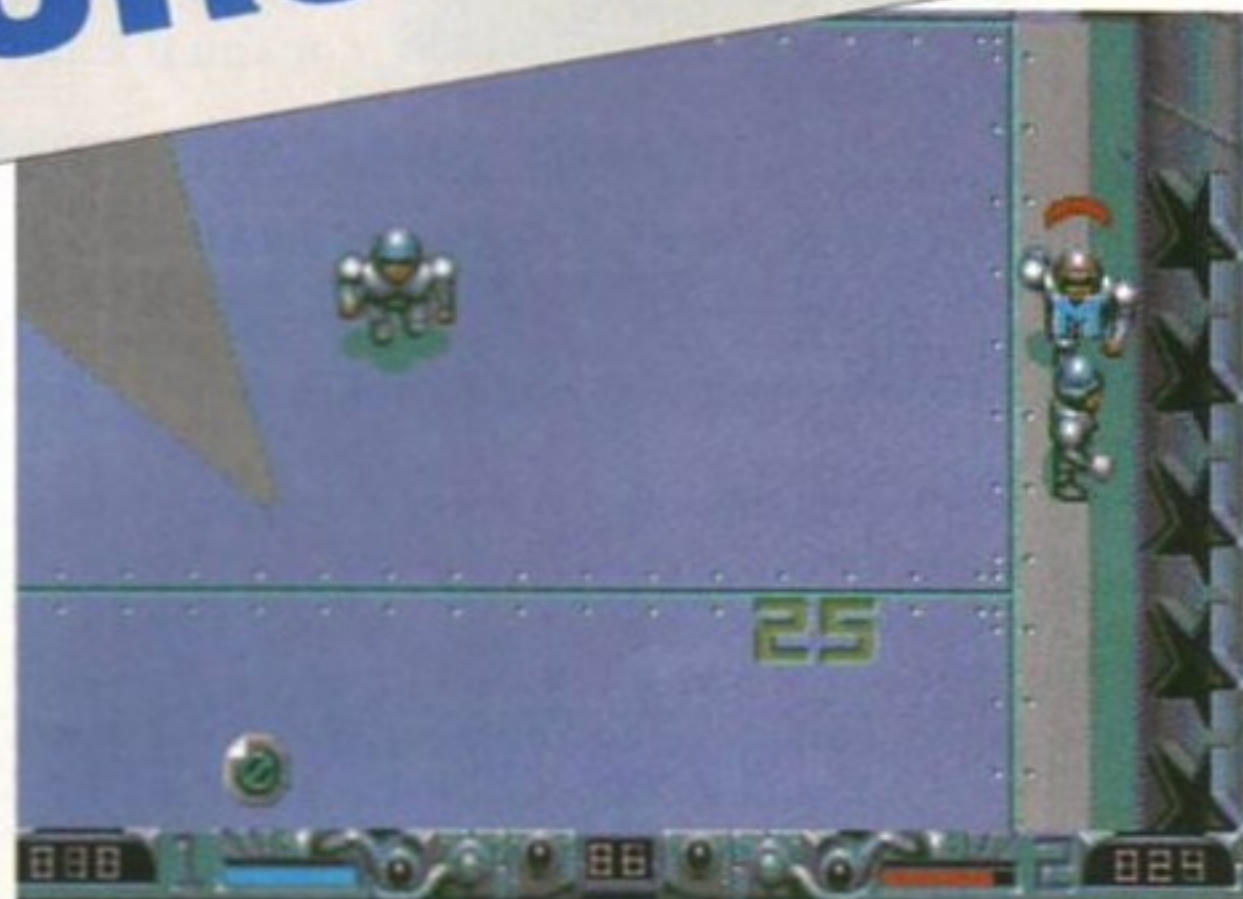

**GIVE IT A GO — YOU NEVER KNOW, YOU MIGHT EVEN LIKE IT!**

# Step forward into the World of **microdeal** music

## SAMPLERS & SEQUENCERS EXPLAINED

### SAMPLE

A sound that has been loaded into a computer, and is represented by numbers (digital) rather than noises (analogue).

### SAMPLER

Usually a small cartridge that allows you to take sounds from a microphone (with amplification), tape, CD etc and record (digitize) them into your computers memory. Once in the memory a sample (sound) can be changed using the sampling software.

### SAMPLING SOFTWARE

Allows you to alter sounds that have been digitized by the SAMPLER. Normal functions with sampling software include loading and saving a sample to disk, altering the sample by cutting, speeding up/down, fading in/out, joining to other samples and much much more.

### SEQUENCER

A sequencer allows you to take samples and play them back in an order (sequence) that you determine. For example, if you sampled a piano note, a sequencer would allow you to play that note back at different pitches and in a sequence you decide. Your one note loaded into a sequencer can become a complete piece of piano music.

## A.M.A.S.

...THE ADVANCED MIDI AMIGA SAMPLER...



Our top level sampler for the Amiga 500/2000 and 1000\* (\*special order) combines top of the range electronics with a sensible price. Our unique wedge shaped cartridge includes a built in MIDI interface (in, out & thru) eliminating the need to swap between sampler and midi interface. Other ports include microphone input and phono left & right in. Our software is a "winning package" as described by AMIGA WORLD magazine, and incorporates a state of the art stereo editing suite with virtually every feature you'd want to lay your hands on. A separate MIDI control panel allows utilisation of the built-in interface with the possibility to play back up to 10!!! different samples pitch shifted

on your MIDI keyboard. Don't think AMAS is a toy either, our price policy brings high quality products to you at sensible prices. Used by amateurs and professionals AMAS was featured by Paula Abdul in her award winning video Cold Hearted.

**Cartridge, software & manual £99.95**

## QUARTET

This sophisticated sequencer allows you to take samples and sequence them into music. Imagine your samples as a band with QUARTET as the conductor, your band is composed of 16 instruments of which 4 can play at any one time. QUARTET comes with 100 instruments and sounds for inclusion in your own compositions and further sounds can be added using AMAS, MASTER SOUND or most other quality samplers. Music can be input from the Amigas' keyboard, by mouse or if you have a synthesizer keyboard with a midi out socket by playing on the keyboard. Control of samples includes Tempo, Volume, Pitch together with a built-in editor for changing samples without exiting QUARTET. Who knows you could easily be tomorrow's "Adamski" or "Mozart" with this highly acclaimed package.

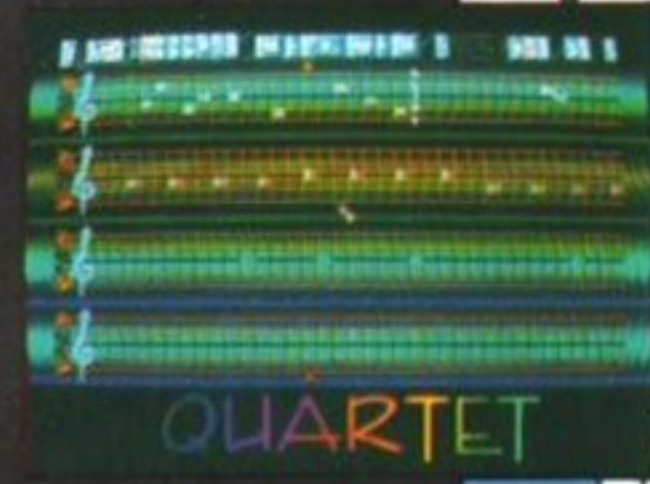

**Software & manual £49.95**

## MASTER SOUND

Our mono sampler is low in price but high in features. Our stylish cartridge for direct connection to your parallel port!!!! has a built-in mono audio in socket suitable for input from the headphone socket on your Walkman, cassette or CD player. Full feature editing software includes cut, paste, fading, filters, scope, graphic equaliser etc, and MASTER SOUND even has it's own built-in mini sequencer for real time recording of your own music sequences. "AMIGA FORMAT" magazine said "it produced some of the best quality samples I have ever heard". If you are looking for a low cost sampler that's packed full of features then look no further.



**Cartridge, software & manual £39.95**

## MIDI INTERFACE

Our low cost MIDI INTERFACE provides the easiest way of hooking up your Amiga to a Midi Music Keyboard. Complete with cables that just plug straight into your IN/OUT midi ports and a disk of Public Domain midi software.



**Midi Interface £24.95**

TO ORDER: SIMPLY PHONE 0726 68020 WITH YOUR CREDIT CARD NUMBER OR POST YOUR CHEQUE/POSTAL ORDER OR CREDIT CARD NUMBER TO: MICRODEAL LTD P.O. BOX 68 ST AUSTELL CORNWALL PL25 4YB.

NAME.....

ADDRESS.....

POSTCODE.....

ALL PRODUCTS FOR THE AMIGA EXPIRY DATE.....

PLEASE SEND ME	QTY	PRICE EACH	TOTAL
AMAS		£99.95	
MASTER SOUND		£39.95	
QUARTET		£49.95	
MIDI INTERFACE		£24.95	
POST & PACKING		£1.00	

GRAND TOTAL ENCLOSED



CREDIT CARD NO.....

**Winners Box**

The wonderful *Eye of the Beholder* maps and tips are well worth this month's prize, so a mail-order voucher is on it's way to Paul Hardy for the tips and another goes out to Mike Kershaw for the maps. Well that's the big stuff sorted out. What else? Oh yes! Lee Patterson and Bryan Miller win £25 vouchers for their Helping Hand cheats! Enjoy your prizes, folks!

If you've got a cheat, hint, map (we still like them as IFF files on disk folks) or solution, then get them sent in to **GAMEBUSTERS, Amiga Format, 30 Monmouth Street, Bath BA1 2BW**. To help us sort out all the tips, write down the name of the game you are sending tips for on the back of the envelope.

Sorry, but we can't enter into personal correspondence, so make sure you **DON'T** send originals of disks or solutions, since we can't promise to return them.

# Game Busters

Well, it's getting late-on in the holidays, and you're all obviously trying to get that last mad thrash out on your favourite games before you have to pack away your joystick and start working again. The problem is, how are you supposed to finish off that tricky level before you quit? Well all you have to do is read **Maff Evans'** hot tips in this month's latest thrilling installment...



**SWIV**

This is a good shoot-em-up, is it not? Well, obviously we thought so, that's why we gave it a *Format Gold!* Still, as is the nature of shoot-em-ups, they are a little difficult once you get stuck into them! Fortunately, a whole host of you helpful readers have sent in this little cheat to help you along.

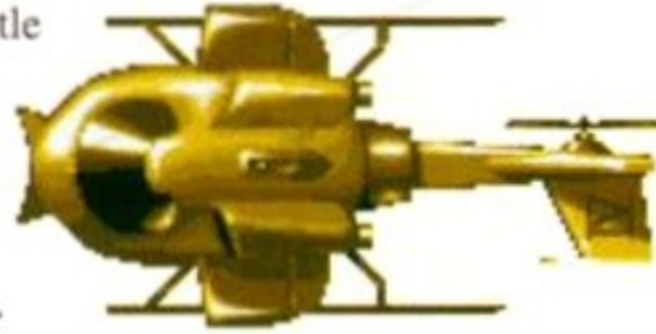

Start the game as normal and press P to pause, then type in NCC-1701. The game will be so impressed at your knowledge of *Star Trek* it will give you infinite lives! Not bad, eh?



**PP HAMMER**

More puzzle game mayhem! This time featuring pneumatic tools. Whatever next? These tools are dangerous things, and they should only be handled by experts. This could explain why you can't get very far in the game! Never mind, try these codes for size and romp through with ease!

LEVEL	CODE			
2	WUCREBWA	24	IBIWHFJD	45
3	HTSJVAUW	25	AABVJEAC	46
4	WRIJWVIW	26	FWVJIDSB	47
5	HJBIJUWV	27	BUHICBRB	48
6	WIWHSTSU	28	UTEJEAF	49
7	HGIHGRRU	29	BSUJUWTA	50
8	WFFGLJFT	30	FJRRWUGW	51
9	HEVECITS	31	BIDSJTFV	52
10	WCSEEGHS	32	UHASTSAV	53
11	HBEFVFR	33	BFREGJIV	54
12	WABFAEBR	34	FEHFIDT	55
13	IVRCSICIJ	35	BDACCHCT	56
14	AUHDUBDI	36	UCUBEGUS	57
15	ITADHACI	37	BAGBVEES	58
16	ASUAIWUH	38	GWDABDWR	59
17	IJGCCUEG	39	CVTHSCVJ	60
18	AIDCEIWG	40	VTJHUAJJ	61
19	IHTUWSUF	41	CSCGGWAI	62
20	AFFUBJEF	42	IGRWFVSH	63
21	IECTSIWE	43	CIIECTRH	
22	ADSWUHVD	44	VHFFFSFG	
			CGVFWRTG	

**Martin Devlin,**  
Knightswood, Glasgow

**GEM-X**

Pondering over a puzzle game can be great fun, especially when the presentation is as lovely as this one's. However, it can be frustrating to be slung out of the game just because you can't get the knack of one screen! If this is the case then here's a treat for you: a list of the level codes to help you bash through to the end of the game.



LEVEL	CODE
B	EARTHIAN
C	KENICHI
D	INOKUMA
E	BURAI
F	BADMAN
G	NETWORK
H	YOKOHAMA
I	EXACT
J	X68000
K	TURRICAN
L	REDMOON
M	CAMPAIGN
N	MAGAMANN
O	SYVALION
P	FMTOWNS
Q	CHIERIE
R	GAMERION
S	ZAWAS

**Murray Clarke,**  
Solihul, West Midlands

**SHADOW DANCER**

A lot of people enjoyed this martial-arts thrash, but I have to say I found it pretty frustrating. What? You did too? Well why not try this cheat for size?

During the game, press pause and type in GIVE ME INFINITIES. You will now be blessed with infinite credits and magic. That should make all those baddies easier to kill off!

**Malcolm Davies,**  
Evesham, Worcestershire

# Eye of the Beholder

Not since *Dungeon Master* has there been a game that has stirred the adventure-game scene so much. In fact it has been winning fans all over the place due to its superb presentation, rich atmosphere and sheer depth. However, this adventuring lark can be difficult for novice game players, so here are some hints and maps to get you going.

AMIGA FORMAT

104

SEPTEMBER 1991

- A** - This is where you will find a dwarf who is willing to join your party.
- B** - There are a lot of inscriptions written on the walls for you to read.
- C** - This room where you will find some clothes and a medallion to use later on.
- D** - When you search this room, you will come across a Dwarven Shield.
- E** - A sealed-off entrance with a note warning of the evil beyond. You should use the Stone Medallion here.
- F** - This room is labelled as the 'Oracle of Knowledge'. It is where you can find out about all your magical items.
- G** - The Stone Sceptre can be located in this room. It is the item that works the fireplace teleport systems.
- H** - This ring improves your armour class by three points.

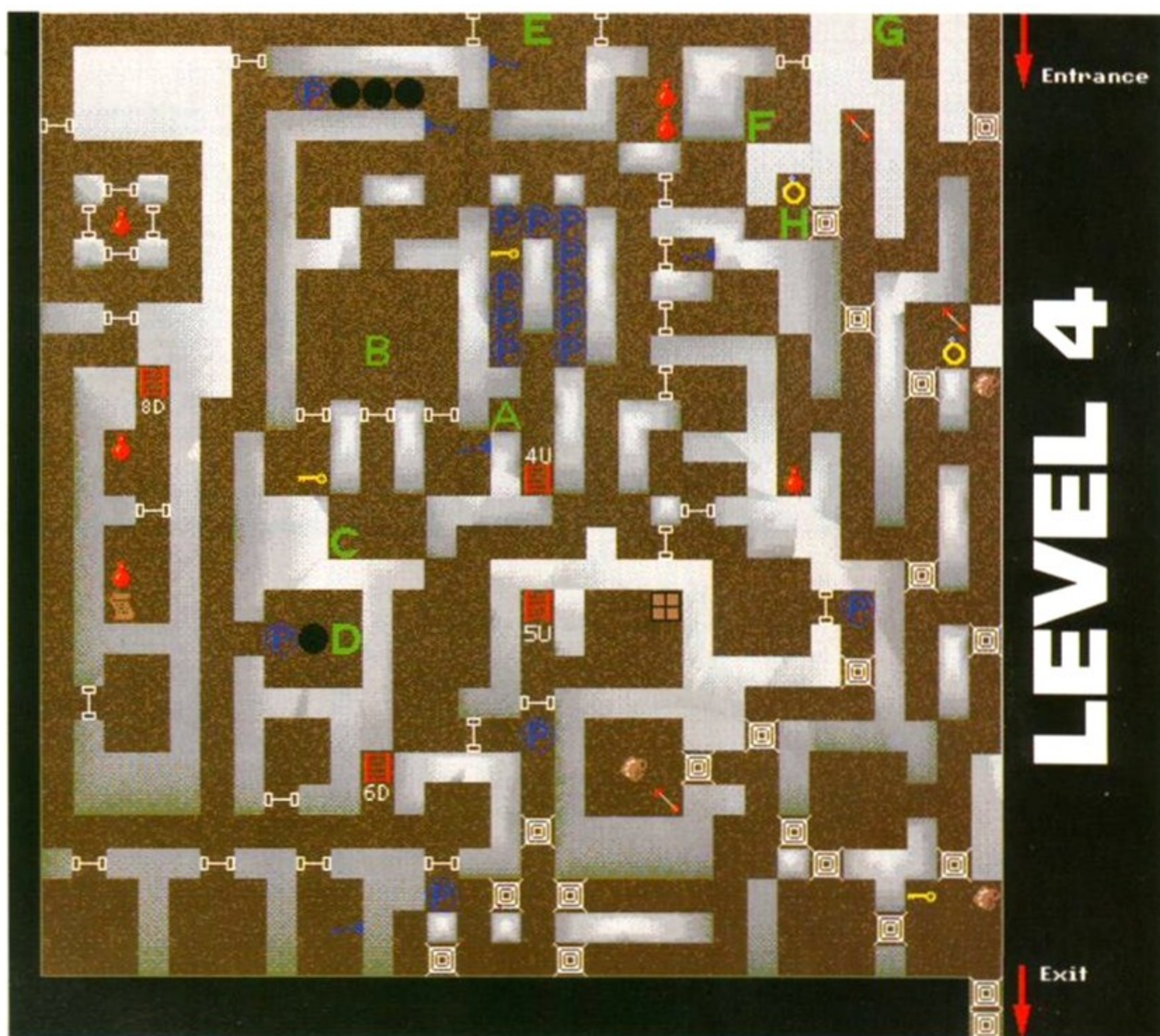

## THE MAPS

Maps to the first few levels are included in the package, so you only need additional maps from Level Four. Here are guides to three of the sewer levels to get you started. If you still have trouble, we'll try and bring you more as we get them, so keep watching this space!

## CREATING YOUR PARTY

There are only four basic character classes for you to choose from and these are: Warriors,

Clerics, Mages and Thieves. In order to complete your quest successfully, you will need at least one of each character type to join you in your party.

Warriors (Fighters, Rangers and Paladins) are highly skilled with weapons and will be extremely useful at the front of your party, where they will be able to handle most of the melee fighting.

Thieves are only average fighters, but they come into their own in certain locations, since they are the only character class with the ability to pick locks.













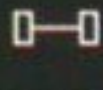

Mages and Clerics should stay at the back of the party, so that they can cast spells without fear of being wounded in battle. Mage spells are mostly offensive, with Clerics casting spells of mainly a defensive nature. Clerics are particularly useful, since they are the only class (except for Paladins) with the ability to 'turn' undead monsters.

Demi-Humans are initially more powerful than their human counterparts, since they can become multi-class characters.

When selecting characters beware of the Class Restrictions, because a Dwarven Cleric,



## KEY

	LADDER		KENKU EGG
	DOOR		ROCK
	HOLE		SCROLL
	PRESSURE PAD		FALSE WALL
	SPIDER WEB		FOOD
	LEVER		RING
	POTION		ARROW
	KEY		

can only proceed to Level 10. Once the maximum level for a character has been reached, they may not increase any further in rank. For example, a Halfling Fighter isn't as good as a Dwarven Fighter, since the Halfling can only proceed to Level Nine. Bear these restrictions in mind when sorting out your team's attributes.

Half-Elves seem to be a good choice, because they are semi-resistant to certain spells and poisons. They also have the greatest number of available classes and have no level-restrictions. However, DON'T select Elves as Player Characters! They do have certain advantages over other classes, but they can't be raised from the dead by any means!

### MEMORISING AND CASTING SPELLS

As you can see in the manual, Clerics and Mages cast rather different types of spells. You have to know what spells are initially useful and how to proceed with the various kinds of magic.

First level Mages will find DETECT MAGIC and MAGIC MISSILE spells useful to begin with. DETECT MAGIC reveals any magical items the team may be carrying, while MAGIC MISSILE is (as you may have gathered) a low-level offensive spell. As a Mage increases in level, he will gain much more effective attacking spells such as MELF'S ACID ARROW, LIGHTNING BOLT and CLOUDKILL.

Clerics should select CURE LIGHT WOUNDS and BLESS spells to benefit the party in combat. Clerics' ranks increase so they will gain more powerful spells like CREATE FOOD AND WATER, NEUTRALISE POISON, FLAME STRIKE and RAISE DEAD.

Both types of magic users need to memorise or pray for spells in order to commit them to memory. Once you have selected the spells you want to

memorise, rest your group for a while and the spells will be remembered ready for casting. If there are any creatures nearby, you won't be able to rest, so move away from any nasties so that you can't even hear them.

Spells may be found on scrolls which are throughout the sewer systems and may be for either Clerics or Mages. Spells for Mages can be used directly from the scroll or transferred to their spell book using the SCRIBE command from the CAMP menu. Whichever you select, the scroll will vanish from the Mage's hands when used. Note that you can only Scribe spells into the book that the Mage doesn't yet have!

Clerics, unlike Mages, don't have spell books. Therefore Clerics can only use spells directly from the scrolls, so they can only be used once.

### FEEDING TIME

You must always make sure that your characters are well fed! You will notice that there are both small and large food packages, offering according amounts of nourishment. There are also some potions which, once drunk, can drive away hunger. The best way to nourish your party is to get a Mage to cast a CREATE FOOD AND WATER spell when they can. This will restore all the team members' Food bars to maximum.

### LET BATTLE COMMENCE

Most of the other characters you will come across will be hostile, so it's vital to adopt a good combat technique. Position any Fighter-type characters you employ in positions one and two and any Clerics or Mages in positions three and four. This way your Fighters will be able to battle on the front line while being backed up by spells cast from the back of the formation.

**Continued overleaf**



**ocean**  
**Acclaim**<sup>TM</sup>  
 entertainment, inc.

- A** - Operating this lever will reset all the holes found in the room below.
- B** - A magic ring is to be found here with an unspecified use. Experiment to try and find a useful place to use it.
- C** - There are a few useful items to be found here including a Scroll containing the Spell of Invisibility, a 10-foot rod and also the Plate Mail armour.
- D** - This is where you will find the Scale Mail armour and a key.
- E** - You will come across a dwarf at this point, he will give you a mission and will tell you how to use the portals.
- F** - This is the Cleric Dwarf. He comes in extremely useful, since he can heal your party and raise the dead.
- G** - In order to operate this portal, you need to use the necklace found at point H.
- H** - This is the Stone necklace which is to be used with portals and it is what you need to use at point G.
- J** - Here is where you will find an extremely useful spell to add to your magic - the Wand of Cone of Ice.

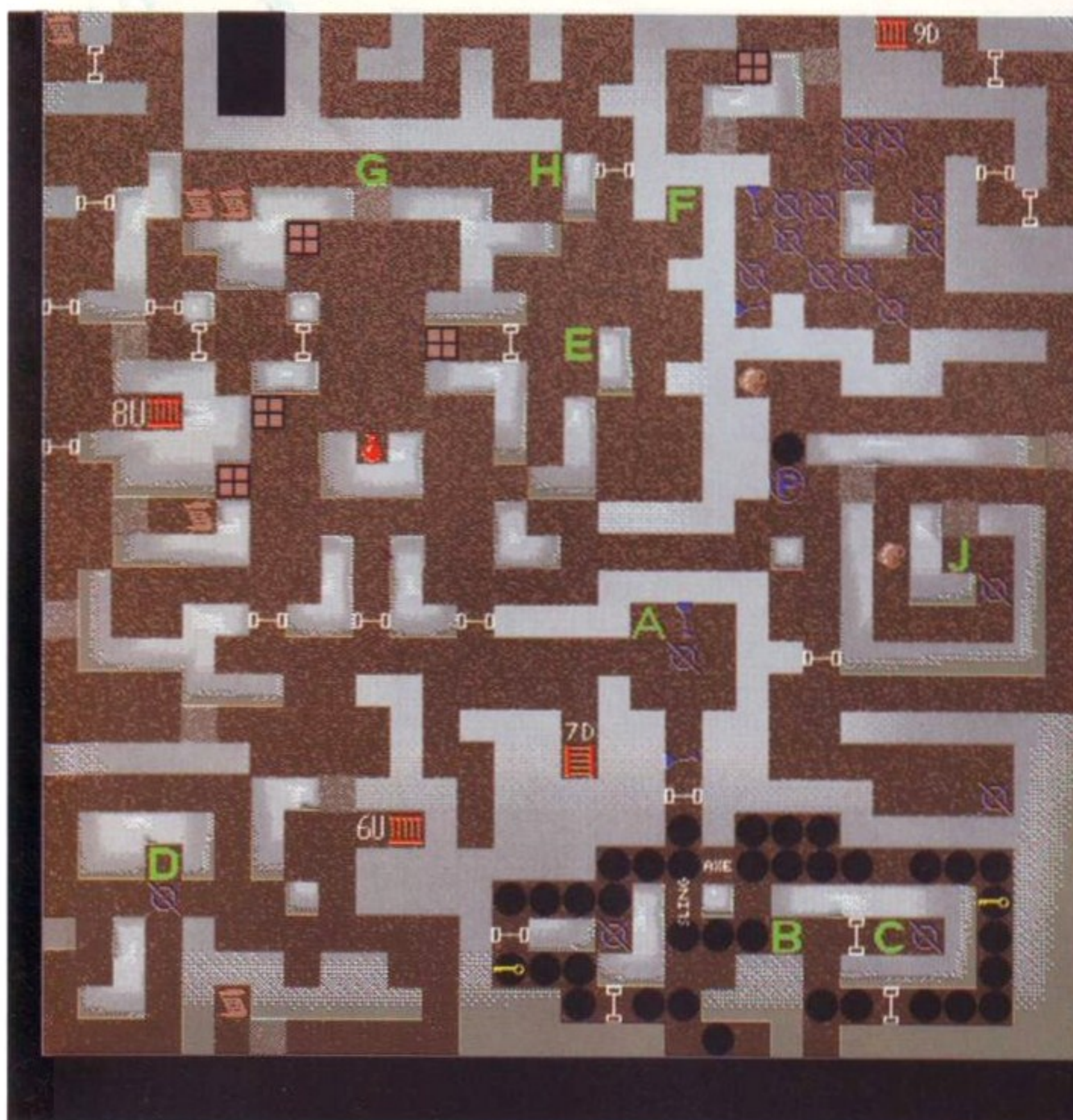





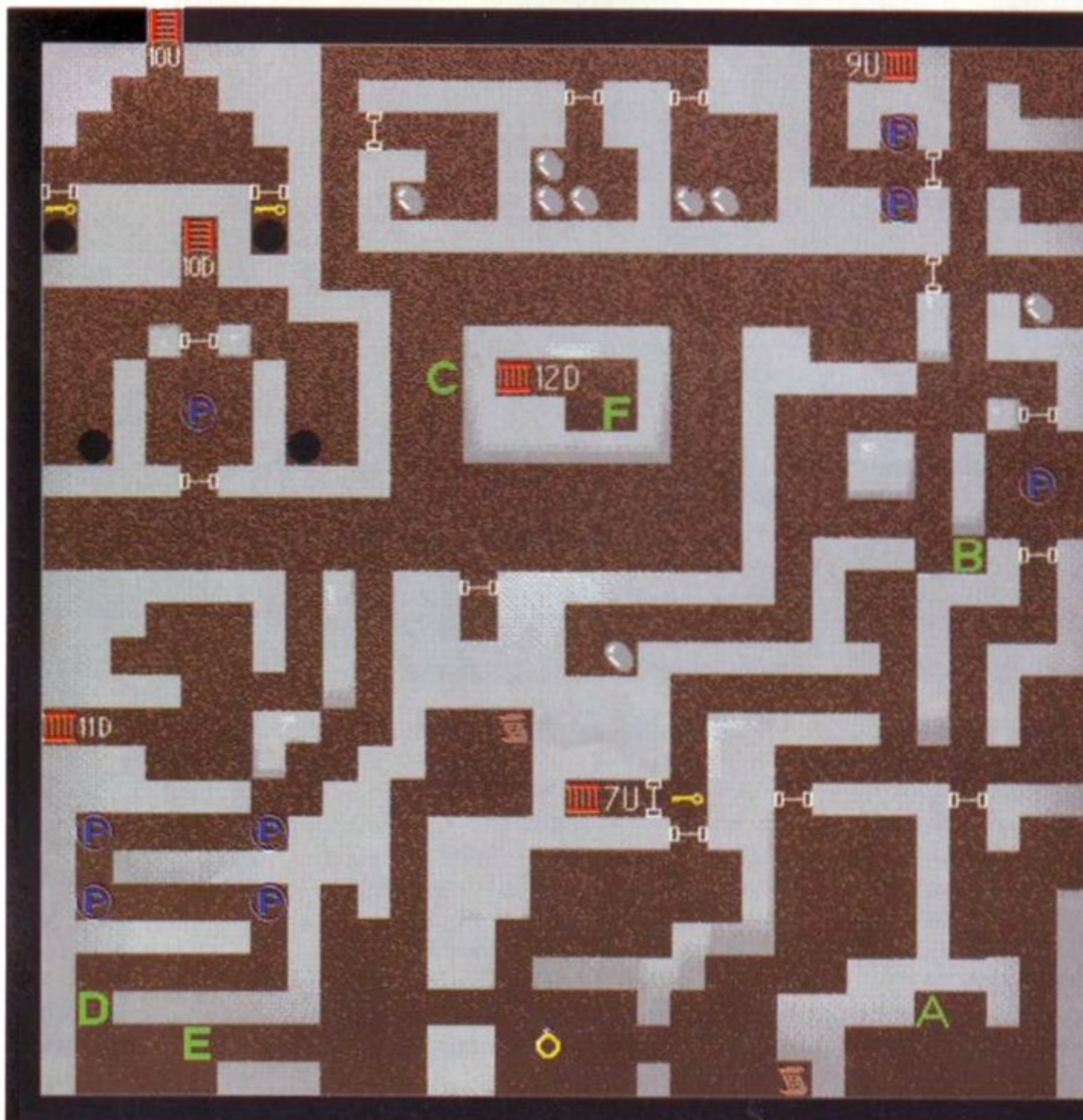









LEVEL 5

- A** - The Bracers can be found here. You can use this piece of armour to deflect shots fired at you by enemies.
- B** - Here is a hostile Mage who will attack your party. Also to be found here is the 'Cone of Cold' Wand and some potions.
- C** - In order to operate this portal you will need to use the Stone Ring, which you can find at point F.
- D** - Should you look around at this point, you will find an extra piece of weaponry in the form of an Adamantite Dart.
- E** - A useful magical weapon - the 'Magic Missile' Wand - can be found here.
- F** - The Stone Ring that you need to operate the portal at point C is here.



LEVEL 6

## KEY

	LADDER		KENKU EGG
	DOOR		ROCK
	HOLE		SCROLL
	PRESSURE PAD		FALSE WALL
	SPIDER WEB		FOOD
	LEVER		RING
	POTION		ARROW
	KEY		

Unlike *Dungeon Master*, this adventure game doesn't allow you to injure monsters by closing doors on them. Instead you have to hold your ground and fight it out with an enemy. Alternatively you can swipe at your opponent, step back and swipe again and so on until he is slain.

Don't be afraid to execute a 'tactical retreat' – all right, run away if that's what you want to call it! It is sometimes easier to close yourself off in a room to cast healing spells than it is to try and heal a player while fighting.

Undead creatures are usually pretty easy to overcome, providing you have a Cleric handy! Use the Cleric to turn the creature, then follow it as it runs away, striking it in the back with your weapons and spells until it drops.

Giant Spiders and Mantis Warriors are another kettle of fish completely. These creatures are VERY dangerous! Spiders are poisonous, and poison is fatal unless you cast a NEUTRALISE POISON spell or find a Potion of CURE POISON. SLOW POISON spells will postpone a character's death, but the next time you rest your party, the poisoned character will die in their sleep.

Mantis Warriors will paralyse a character if they manage a successful strike. Paralysed characters can't attack or cast spells and will be useless during combat unless a Cleric casts a REMOVE PARALYSIS spell on them.

With both these creatures, your best method of combat is to cast offensive spells from a distance. If you have to take part in close combat with them, use the swipe and retreat method as detailed previously. Make sure that you don't back into a dead-end though, because this is likely to be certain death!

### ADVENTURING

It's a good idea to make sure that you select characters from different races for

your party, since you will find messages (Shouldn't that be messages? – Ed) on some sections of walls in the sewers. Some of these will be in Common (so anyone can read it), but others may be in Dwarfish, Elvish or another language. Unless you have someone who can understand the language, you will be unable to decipher the writing, which is often important when solving puzzles.

When you find some writing and a character utters, "What a strange marking to place here," insert a dagger in to the crack in the wall and this will open a secret door.

You will find two skeletons on the earlier levels, both of which you must take. Later in the game you will be able to resurrect the dead adventurers, which will then join your party as non-player characters. As they say – six heads are better than four... don't they?

Agree to help the Dwarves on level four and allow Dohrun the Dwarven Fighter to join your party. You may now visit the Dwarven Cleric, who will heal wounded party members and resurrect any that have been slain.

Whenever you find new items, use a DETECT MAGIC spell to see if they have any magical properties. This won't actually reveal what they do (you can only find that out by experimenting), but it will give you some indication of what magical items you possess.

Never fight the Rust Monsters hand-to-hand. Instead use missile weapons and long-range attacking spells such as MAGIC MISSILE and MELF'S ACID ARROW. Rust Monsters don't injure characters when they strike, instead they dissolve a metallic object the character is carrying – usually armour or weaponry!

Tips from: Paul A Hardy,  
Wales, Sheffield

Maps from:

Mike Kershaw, Weeks, Winchester



**ocean**  
**Acclaim**<sup>TM</sup>  
entertainment, inc.

ACCLAIM<sup>TM</sup> AND MASTERS OF THE GAME<sup>TM</sup> ARE TRADEMARKS OF ACCLAIM ENTERTAINMENT INC.  
THE SIMPSONS<sup>TM</sup> & © 1990 TWENTIETH CENTURY FOX FILM CORPORATION. ALL RIGHTS RESERVED.

## Helping Hand

Once more **Maff Evans** tries to help out all those struggling games players. If there is a problem that he can't answer, maybe you can help? You could win yourself £25!

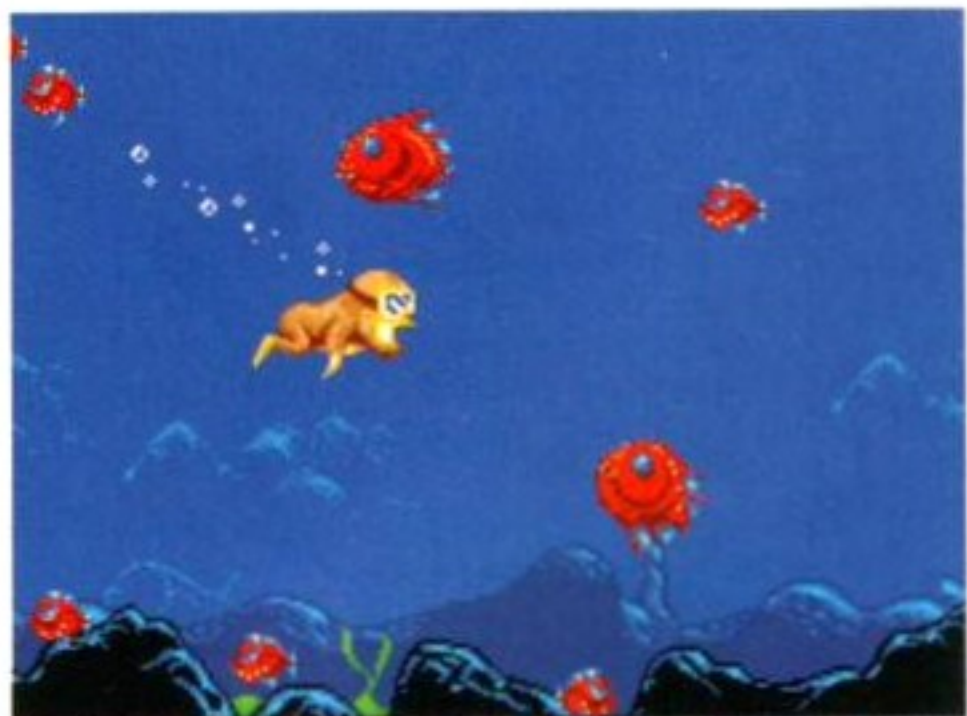

### Too much monkey business

I have just bought the game *Toki*, but I'm having a bit of a problem: basically I cannot get past the first section. Can you tell me the cheat code?

Joshua Entwistle,  
Manchester

Well today's your lucky day! Here's a solution courtesy of Bryan Miller in *Elantyre, Glasgòw*. All you have to do is start the game and type in **KILLER**. You will then be blessed with infinite credits and the ability to select levels by pressing **F1** to **F8**. What more could you possibly ask for?

### In space, no-one can hear you whinge

I was wondering whether your magazine has ever done a full solution to the game *Space Ace* by Readysoft. If you have, could you tell me how I could get hold of a copy?

Lewis Mackenzie,  
Alness, Rosshire

Well we did print a full solution way back in issue 10, but this is unfortunately no longer available. However, all is not lost because it was reprinted in the *Screenplay* book.

### Looks like a job for weedol!

This may be a totally stupid question to ask you, but how the hell do you get the last two stones on Level 10 of *Archipelagos*?

Simon Harrison,  
Salford Priors, Worcestershire

A stupid question? In Amiga Format? Perish the thought! In order to get all of the stones, you have to follow one fundamental rule. You have to be able to

reach the stones by a **CLEAR** land-path. That is by straight, not diagonally, connecting squares with green land (not sand) on them. Once you've set up your land-path, you can then destroy the last two stones and go on to take out the Obelisk.

### Helping hand and the last cheat mode

Please could you print a cheat for *Indiana Jones and the Last Crusade*, because I am totally stuck!

Paul Reeves,  
Polegate, East Sussex

A lot of people have been asking about this, and I'm glad to say that I do have some maps and a solution, so a full set of hints will be printed soon. How soon? Well how does next issue sound? Ah, I thought that would make you happy!

### Cruise for a cheat

In Issue 23, you asked for a cheat on *Days of Thunder*. I have just discovered this weird cheat. First, enter the qualifying race as normal and press **P** to pause the game. Now type **COMEFLYWITHME**. The screen should flash to confirm the code, and when you un-pause the game you can pull back on the joystick to soar into the air. Use the fire-button to move forward and the function keys to get a view of yourself flying through the sky.

Lee Patterson,  
Burscough,  
Lancashire

Well done, Lee. Thanks for your help! A £25 Helping Hand voucher will be on its way to you soon!

### Divine Inspiration

A lot of people have been writing in wondering about the pass codes in *Renegade's Gods*. Unfortunately, the manual doesn't explain how to find them very well!

The game is divided into Levels and Worlds, with three Worlds per Level. To get a password, which will allow you to begin at the start of a Level, you must have completed at least the first World of a Level AND reached the shop which immediately follows. When you eventually die the

password will be displayed on the high-score table. If the second disk is write-enabled the password will have been saved to the score table on the disk. Just inputting the password, though, won't take you to the shop, it will only take you to the beginning of the Level reached. Due to the strange font, **U** and **V** tend to look similar – so don't get confused!

Another thing to note is that the codes only apply to the copy of the game they were found on! Any attempt to use them on someone else's copy of the game won't work at all, so don't bother sending them in! All those people that have already sent me codes, sorry but their just no use to me!

Well that's it for another month, I'm afraid. Sorry if your letter wasn't answered, don't worry though, because the solution may come up in a future issue. Before I finish, a note to all those people asking for photocopies of maps and solutions. I'm sorry, but we just don't have the time to reply to letters personally, so I can't send any letters out, even if they come with a stamped-addressed envelope. All I can do is print tips in *Gamebusters* and *Helping Hand* or tell you where you can get help.



**If you're stuck on a particular game or have a solution to another reader's problem then write it down and send it in to us at HELPING HAND, AMIGA FORMAT, 30 MONMOUTH STREET, BATH BA1 2BW.**

# £100,000.00 worth of stock **MUST** be sold.

A unique opportunity to purchase major manufacturers stock at silly prices. We are moving to new premises and to save us carrying all this stock it must be sold this month only.

## **JUST LOOK AT THESE PRICES!**

100 DSDD 135 TPI DISKS PLUS 100 CAPACITY  
3.5" LOCKABLE BOX **£44.95**

**100% CERTIFIED**

**OR**

**100% GUARANTEED**

200 DSDD 135 TPI DISKS PLUS 2  
100 CAPACITY 3.5" LOCKABLE BOXES **£69.95**

All diskettes supplied are absolutely 100% certified and guaranteed supplied by one of the worlds most premier manufacturers. Storage boxes are antistatic, lockable, have plenty of dividers.  
All diskettes are supplied with superb colour coded labels.

**REMEMBER THE PRICE YOU SEE IS THE PRICE YOU PAY!**

## **MD OFFICE SUPPLIES**

**18 CRESCENT WAY, ORPINGTON, KENT, BR6 9LS**

**TELESALES HOTLINE: 0689 861400**

EDUCATIONAL & GOVERNMENT ORDERS WELCOME



# COMPUTER MATES LTD

TEL. 0753 631101 (3 Lines)  
FAX. As Above



CHEQUES/POSTAL ORDERS TO:  
COMPUTER MATES LTD.  
PINWOOD STUDIOS  
IVER HEATH  
BUCKS SL0 0NH



## FED UP WAITING?

WE GUARANTEE 48 HOUR  
DELIVERY TO YOUR DOOR  
AT NO EXTRA COST!!!  
WITH 90% OF PARCELS  
ARRIVING NEXT DAY!

### MITSUBISHI BRANDED THE THREE DIAMOND DISKETTES

PROBABLY THE MOST RELIABLE DISKETTES ON THE MARKET  
NO QUIBBLE REPLACEMENT. 100% ERROR FREE. MADE IN JAPAN.

#### M-2D 5 1/4" DSDD

1 BOX	£6.00
2-5 BOXES	£5.50
6-10 BOXES	£5.00

#### M-2HD 5 1/4" DSHD

1 BOX	£8.95
2-5 BOXES	£8.15
6-10 BOXES	£7.60

#### MF-2DD 3 1/2" DSDD 1MEG

1 BOX	£8.65
2-5 BOXES	£8.15
6-10 BOXES	£7.10

#### MF-2HD 3 1/2" DSHD 2MEG (1.44)

1 BOX	£15.75
2-5 BOXES	£14.70
6-10 BOXES	£13.65

#### FREE GIFTS WHEN YOU BUY MITSUBISHI BRANDED DISKETTES!

1 BOX ..... FREE MOUSEMAT    5 BOXES ..... FREE 50 CAP BOX    10 BOXES ..... FREE 100 CAP BOX

COMPUTER MATES — THE FIRST MAIL ORDER SUPPLIER OF MITSUBISHI BRANDED DISKETTES

QUICKSHOT JOYSTICKS	3 1/2" MITSUBISHI BULK LIFETIME GUARANTEED	COLOURED DISKS
SEGA/ATARI/MSX/ AMSTRAD/COMMODORE	3 1/2" DSDD	DSDD WITH LABELS RED, YELLOW, ORANGE, GREEN, WHITE
MAVERICK I ..... £14.50	50 DISKS ..... £18.00	10 DISKS ..... 5 1/4" £4.00    3 1/2" £4.50
FLIGHT GRIP ..... £11.50	100 DISKS ..... £35.00	25 DISKS ..... £8.75    £10.75
PYTHON I ..... £11.50	200 DISKS ..... £68.00	50 DISKS ..... £16.50    £21.00
STARFIGHTER I ..... £35.00	500 DISKS ..... £152.00	100 DISKS ..... £28.50    £40.00
(Remote Control/Wireless)	1000 DISKS ..... £295.00	
ATARI/COMMODORE	INCLUDING LABELS	
APACHE I (Digital) ..... £9.00	5 1/4" BULK DISKS	14" MONITOR STAND SWIVEL WITH HANDY KNOB ..... £13.50
TURBO II ..... £11.50	LIFETIME GUARANTEED. PACKED IN 25's INCLUDING LABELS	80/132 PRINTER STAND WITH PAPER TRAY ..... £9.00
APPLE 2E/C, IBM PC	48 TPI	A4 DESKTOP COPYHOLDER ..... £7.50
AT/XT ..... £14.50	25 DISKS ..... £8.15	
MOUSE MATS ..... £2.50	50 DISKS ..... £15.50	
MOUSE HOLDERS ..... £2.00	75 DISKS ..... £21.50	
HEAD CLEANERS 3.5" or 5.25" ..... £2.00	100 DISKS ..... £27.50	
MINI VACUUM ..... £6.00		
CLEANING SOLUTION ..... £2.00		

## BLUE BOX PRODUCTS

ALL BLUE BOX PRODUCTS ARE COMPLETELY PACKAGED IN  
PRINTED CARDBOARD BOXES WITH LABELS. 100% GUARANTEED.

#### BAMBI-2DD

25 DSDD 3 1/2" IN 25  
CAP STORAGE BOX

1 BOX	£14.00
2+	£13.00
5+	£11.00

#### MF-2DD 30's

30 DSDD 3 1/2"

1 BOX	£14.00
2+	£13.00
5+	£11.00

#### MF-2DD 10's

10 3 1/2" DSDD

1 BOX	£6.00
2+	£5.00
5+	£4.50

#### M-2D 48 TPI 10's

10 DSDD 5 1/4"

1 BOX	£4.25
2+	£3.75
5+	£3.25

#### M-2DD 96 TPI 10's

10 DSDD 5 1/4"

1 BOX	£4.75
2+	£4.25
5+	£3.75

#### BAMBI-2HD

25 DSHD 3 1/2" IN 25  
CAP STORAGE BOX

1 BOX	£21.00
2+	£20.00
5+	£18.50

#### MF-2HD 30's

30 DSHD 3 1/2"

1 BOX	£21.00
2+	£20.00
5+	£18.50

#### MF-2HD 10's

10 3 1/2" DSHD

1 BOX	£8.50
2+	£8.00
5+	£7.00

#### M-2HD 10's

10 DSHD 5 1/4"

1 BOX	£6.50
2+	£6.00
5+	£5.00

#### DATA CARTRIDGES

VERBATIM DATA LIFE

DC2000	£17.80
DC300XLP	£17.80
DC600A	£19.60
DC6150	£21.50

## STORAGE BOXES

3 1/4"	5 1/2"
120 CAP ..... £9.50	140 CAP ..... £8.75
100 CAP ..... £7.90	120 CAP ..... £8.25
80 CAP ..... £7.50	100 CAP ..... £7.50
50 CAP ..... £6.50	50 CAP ..... £6.50
40 CAP ..... £6.00	

ALL ABOVE BOXES LOCKABLE + 2 KEYS

£2 OFF BOXES WHEN ORDERING 100 DISKS OR MORE

10 CAP ..... £1.50	10 CAP ..... £1.50
5 CAP ..... £1.15	5 CAP ..... £1.00
1 CAP ..... £0.50	

**Call SAM or PAT Now!**  
**on 0753 631101**

## SORRY! SORRY! SORRY!

WE DO NOT PRICE MATCH BUT WE DO GIVE  
QUANTITY DISCOUNT, WITH SERVICE, QUALITY  
AND BACKING FROM THE LARGEST DISK  
MANUFACTURERS IN THE WORLD. IN ADDITION  
OVER 200 LINES OF PERIPHERALS IN STOCK. ASK  
FOR OUR COLOUR CATALOGUE & PRICE LIST  
WITH YOUR ORDER OR SEND 22p S.A.E.

**CALL 0753 631101**

# NEW FROM EveshamMicros



*At Last!* ... the chance to buy **Quality, High Capacity Hard Disk Systems for the Amiga 500 at REALISTICALLY LOW PRICES!**

Specially designed for the A500, our new **Reference SCSI Hard Drive Systems** offer exceptional value for money, incorporating top brand, high performance NEC hard disks!

- ⚙️ NEC SCSI Hard Disk Mechanisms for optimum performance, 25ms Average Access time, with Autoparking
- ⚙️ Includes its own Dedicated PSU. Commodore recommends against use of peripherals without independent power supply.
- ⚙️ **QUIET**... latest technology drives run cool - no fan needed!
- ⚙️ Option for up to 4MB of additional RAM Expansion, made simple through the use of SIMMS - the modern way to upgrade
- ⚙️ Includes SCSI Throughport at rear for further expansion
- ⚙️ High quality metal casing, colour matched to the Amiga 500
- ⚙️ Includes Configuration/Format Software, plus 'MRBackup Pro'

**MRBackup Professional**  
*FREE with every hard drive!*

Included with every hard drive is MRBackup Pro, offering hard drive owners full data security and peace of mind. MRBackup can backup files to floppy disk or SCSI tape streamer, with or without its own "fast" format feature. Features include intuitive user interface, plus Data Compression options which help reduce the quantity of backup media required.

**MRBACKUP PROFESSIONAL**  
Available Separately for Only £29.95

**REFERENCE-40 : £299**  
**REFERENCE-100 : £449**

2MB RAM VERSION: ADD £80 • 4MB RAM VERSION: ADD £160

*Prices include VAT and delivery*

PLEASE TURN OVER FOR FURTHER OFFERS AND ORDERING INFORMATION

# Evesham Micros

PRICES INC. DELIVERY & VAT @ 17.5%

Express Courier Delivery :  
(UK Mainland Only) £6.50 Extra

BUY WITH CONFIDENCE from one of the longest established companies in their field, with a reputation for good service and prices. We have invested heavily in a computer system to enable our Telesales staff to provide up-to-the-minute stock information, coupled with highly efficient order processing. Our fully equipped Workshop enables us to carry out almost any repair on our premises. We feel sure that you won't be disappointed if you choose Evesham Micros.

## HOW TO ORDER....



Call us now on



**0386 765500**



Lines open Monday - Saturday,  
9.00am - 5.30pm

Send Cheque, Postal Order or  
ACCESS/VISA card details to :

**Evesham Micros Ltd**  
Unit 9, St Richards Rd.  
Evesham, Worcs  
WR11 6XJ



ACCESS / VISA  
Cards Welcome



Government, Education & PLC orders welcome

Same day despatch whenever possible  
Express Courier delivery (UK Mainland only) £6.50 extra

Please note that 5 working days must be allowed for  
personal cheque clearance.

Mail Order Fax: **0386-765354**

### RETAIL SHOWROOMS

Unit 9 St Richards Road, Evesham  
Worcestershire WR11 6XJ

☎ 0386 765180

fax : 0386 765354

Open Mon-Sat., 9.00 - 5.30

5 Glisson Rd, Cambridge CB1 2HA

☎ 0223 323898

fax : 0223 322883

Open Mon-Fri, 9.30 - 6.00

and Sat., 9.00 - 5.30

Corporate Sales Dept. • IBM dealer

1762 Pershore Road, Cotteridge  
Birmingham B30 3BH

☎ 021 458 4564

fax : 021 433 3825

Open Mon-Sat., 9.00 - 5.30

TECHNICAL  
SUPPORT

☎ **0386-40303**

Monday to Friday, 10.00 - 5.30

**12 MONTHS WARRANTY  
ON ALL PRODUCTS**

All details correct at time of press • All goods subject to availability, E. & O.E.

## AMIGA 1500/2000 UPGRADES

### HARD DRIVE / RAM UPGRADE BOARD KIT

Kits comprise of full size hard disk controller cards incorporating unpopulated SIMMS RAM expansion sockets for accommodating up to 8Mb RAM; PLUS high speed, fast access NEC SCSI hard disks.

40MB HARD DRIVE & INTERFACE / RAM CARD .... £ 349.00

100MB HARD DRIVE & INTERFACE / RAM CARD .. £ 499.00

PLEASE NOTE: These are unpopulated RAM sockets - Add £119.00 per 2Mb of RAM required.

8Mb RAM Expansion Card with 2Mb Fitted  
easily upgradeable to 4Mb, 6Mb or 8Mb ..... £ 149.95

## 3 1/2" EXTERNAL FLOPPY DRIVES

AMAZING LOW PRICE !

**£51.99**

including VAT & delivery



- Very quiet
- Slimline design
- Suits any Amiga
- Cooling Vents
- Sleek, high quality metal casing
- On / Off switch on rear of drive
- Quality Citizen/Sony Drive Mechanism
- Full 880K Formatted Capacity
- Long reach connection cable

Also available:  
5.25" External Drive  
40/80 Track Switchable  
Only £99.00 inc. VAT/delivery

## AMIGA A500 SOLDERLESS RAM UPGRADES

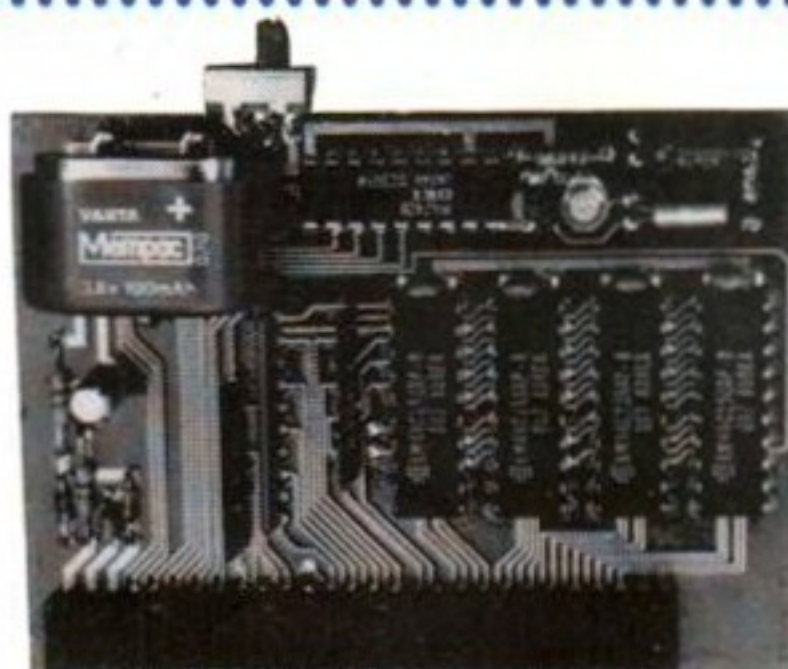

**512K RAM/CLOCK  
UPGRADE**

**ONLY £28.99**

including VAT and delivery

**512K  
RAM/CLOCK  
EXPANSION  
FEATURES :**

- ☆ Direct replacement for the A501 expansion
- ☆ Convenient On / Off Memory Switch
- ☆ Auto-recharging battery backed Real-Time Clock
- ☆ Compact Unit Size : Advanced, ultra-compact design
- ☆ Only 4 low power consumption FASTRAMs

512K RAM Expansion  
also available without  
clock for only  
**£24.99**

## 1.5MB RAM BOARD

- ☆ Fully populated board increases total RAM in A500 to 2MB !
- ☆ Plugs into the trapdoor expansion, and connects to GARY chip
- ☆ Includes Auto-recharging battery-backed Real-Time Clock
- ☆ Socketed FASTRAM ICs for accommodating up to 1.5MB RAM

Unpopulated RAM board with clock ..... £ 34.95

RAM Board as above, with 512K FASTRAM installed .... £ 54.95

RAM Board as above, with 1MB FASTRAM installed .... £ 69.95

RAM Board as above, with 1.5Mb FASTRAM installed... £ 79.00

N.B. : The expansion board requires Kickstart 1.3 to operate -  
Kickstart 1.3 upgrade available from us for £29.95



## NEW! 'MEGABOARD'

**Connects to your 512K RAM  
upgrade to give 1.5MB**

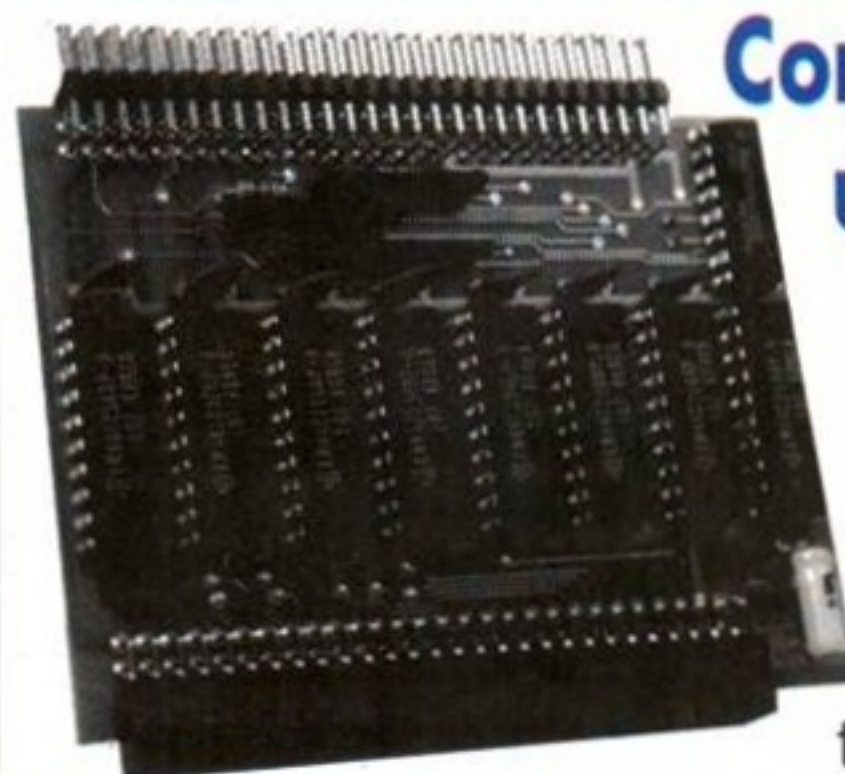

With the MEGABOARD, you can  
further expand your A500's  
memory to a total of 2Mb without  
disposing of your existing 512K  
upgrade (must be 4 x RAM-chip  
type, or not exceeding 9cm in length).

**ONLY £59.95**

MEGABOARD needs Kickstart 1.3 to operate (Kickstart 1.3 upgrade  
available from us for £29.95). Installation requires connection to  
the GARY chip. Easy to follow instructions provided.



Evesham Micros • ALL PRICES INCLUDE VAT & DELIVERY • Evesham Micros • ALL PRICES INCLUDE VAT & DELIVERY • Evesham Micros • ALL PRICES INCLUDE VAT & DELIVERY • Evesham Micros • ALL PRICES INCLUDE VAT & DELIVERY

## ZY-FI amplified stereo speakers

REALISE THE TRUE SOUND POTENTIAL OF YOUR AMIGA WITH THIS PAIR OF FULL RANGE SPEAKERS!



Your Amiga produces fine quality hi-fi stereo sound. Enjoy quality stereo sound reproduction to the full with this specially designed, great new twin speaker system! Features reflex ported speaker design with 3 separate drivers in each unit, and incorporates a built-in amplifier with adjustable volume control. Runs from PSU (supplied) or from batteries (not included). Speaker Dimensions 248x93x125mm (HxWxD)

**ONLY £39.95**

## CBM A590 HARD DISK

Good quality Commodore 20Mb Hard Disk unit, including its own PSU and built-in cooling fan. Features sockets for up to 2Mb of on-board FASTRAM expansion (see below). 80ms Access time, with up to 2.4M/sec. transfer rate. Autoboots when used with Kickstart 1.3.

**ONLY £279.00**

### CBM A590 UPGRADES

(RAM upgrades fitted free of charge when bought with A590)

512K RAM Upgrade	£ 29.95
1Mb RAM Upgrade	£ 59.95
2Mb RAM Upgrade	£ 99.95
NEC 40Mb SCSI Drive replacement mechanism	£ 199.00
NEC 100Mb SCSI Drive replacement mechanism	£ 349.00

### A590 ADD-ON HARD DRIVES

A590 OWNERS! Expand your hard disk storage further with one of our add-on, externally cased SCSI Hard Drives, featuring 25ms autparking NEC mechanisms with separate power supply. Simply plugs into the socket provided on the rear of the A590 Hard Disk unit.

External 40Mb SCSI Drive cased with PSU to directly add-on to the Commodore A590	£ 299.00
External 100Mb SCSI Drive cased with PSU	£ 449.00

## TRUEMOUSE



WE GUARANTEE that this is the smoothest, most responsive and accurate replacement mouse you can buy for the Amiga. Excellent performance, amazing low price!

**£17.95 SATISFACTION GUARANTEED**

GOLDEN IMAGE OPTICAL MOUSE Amiga/ST compatible - excellent travel & accuracy assured ..... £ 29.00

## GOLDEN IMAGE HANDY SCANNER & TOUCH-UP



Outstanding quality, excellent value for money - this package includes a 100-400dpi scanner with dither options, plus the amazingly powerful TOUCH-UP software package which drives the scanner directly. Scanner includes viewing window & backlight for accurate scans every time. Scan either line-art or grey images up to 400dpi. Many image enhancement & special effects available from within Touch-Up. A sensible investment for Desktop Publishing work.

INCREDIBLE VALUE! NEW LOW PRICE - **ONLY £145.00**

## NEW! ROCCEN GENLOCK



YOU WILL HAVE TO PAY AT LEAST TWICE AS MUCH MONEY to obtain a similar level of quality, function and sophistication offered by our new GENLOCK adapter, compatible to all Amigas! Special features include the ability to record graphics & animations on video recorders and overlay graphic and text onto video. Capable of smooth and stable fading and overlaying effects with special tuning knob.

**ONLY £114.99**

## PHILIPS 15" TV/MONITOR



With its dedicated monitor input, this model combines the advantages of a high quality medium resolution colour monitor with the convenience of remote control Teletext TV - at an excellent low price! NEW Version features dark glass screen for improved contrast, plus full range 3-way speaker sound output.

**£269.00** Including VAT, delivery & cable

Philips CM8833 Mk.II including cable ..... £ 239.00

# AMIGA SPECIAL DEALS

## AMIGA 500 COMPUTER BASE PACK

Features a Genuine UK version 512K Commodore Amiga 500 computer with 1Mb Internal Drive, TV Modulator, Mouse, Power Supply, Kickstart 1.3, etc.

**AMIGA 500 BASE PACKAGE ONLY £ 307.49**

**A500 PACK AS ABOVE, WITH 512K RAM/CLOCK FITTED ONLY £ 333.99**

**A500 PACK WITH EXTERNAL 3 1/2" DRIVE ONLY £ 357.49**

**A500 PACK WITH EXTERNAL 3 1/2" DRIVE AND 512K RAM/CLOCK UPGRADE FITTED ONLY £ 383.99**

N.B. Does NOT include extra software included with other packages.

LOOK WHAT ELSE YOU GET WHEN YOU BUY AN AMIGA FEATURE PACK FROM Evesham Micros

THESE FABULOUS GAMES: Tracksuit Manager 90 • Subbuteo • Asterix • Block Alanche • Jungle Book • Treasure Trap • DiskMan • Battle Squadron • Diet Riot • Tank Battle • Nigel Mansell • Lost'N Maze PLUS! A wordprocessor and spreadsheet

## NEW! AMIGA 500 CARTOON CLASSICS PACK

Includes Amiga 500 with 1Mb RAM, plus 1Mb Drive, TV modulator, 'LEMMINGS', 'CAPTAIN PLANET', 'BART SIMPSON vs THE SPACE MUTANTS', 'Deluxe Paint III'.  
**A500 1MB CARTOON CLASSICS PACKAGE ..... £ 369.99**  
**A500 Cartoon Classics PLUS 3 1/2" External Drive..... £ 419.99**

## AMIGA 500 SCREEN GEMS PACK

Includes Amiga 500 with 1Mb RAM, plus 1Mb Drive, TV modulator, 'Night Breed', 'The Beast 2', 'Back to the Future 2', 'Days of Thunder', 'Deluxe Paint II'.  
**A500 1MB SCREEN GEMS PACKAGE ..... £ 369.99**  
**A500 Screen Gems Package PLUS 3 1/2" External Drive .. £ 419.99**

## AMIGA 500 CLASS OF THE 90'S PACK

A500 plus A501 512K RAM Upgrade, TV Modulator, 8 s/ware titles, 10 Disks, mouse mat & more ...  
**CLASS OF THE 90's Package ..... £ 499.00**  
**Class of the 90's Pack plus 3 1/2" Drive..... £ 549.00**

## AMIGA 1500 STARTER PACK

Includes A1500 computer (1Mb RAM, 2 x 3 1/2" Drives, 8 expansion slots), Commodore Hi-Resolution Colour Monitor, plus Software including 'Deluxe Paint III', 'Battle Chess', 'Sm City' and 'The Works' (business software).  
**A1500 STARTER PACKAGE ..... £ 949.00**

## VIRUS PROTECTOR BANISH VIRUS PROBLEMS!

Our compact Virus Protector fits easily to the Port of the last disk drive in your Amiga system, protecting all internal and external drives from boot block viruses. Incorporates a switch to enable or disable the protection facility.

**ONLY £9.95**

## REPLACEMENT A500 PSU

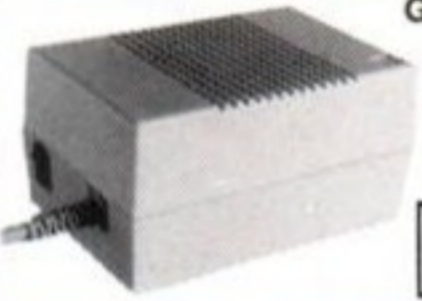

Genuine Commodore Amiga A500 type replacement Power Supply Unit. Good quality 'switch mode' type. Super low price!

**ONLY £39.95**

## MIDI INTERFACE

Our fully compatible, high quality MIDI interface connects directly with the Amiga serial port and provides IN, OUT & THRU ports for good flexibility. Features LED indicators on each port for diagnostic purposes. Superb compact design.

**ONLY £19.95**

## STEREO SOUND SAMPLER

Offering full compatibility with almost any Amiga audio digitiser package, our Sound Sampler features excellent circuitry, yielding professional results. The main A/D converter gives a digitising resolution of up to 50KHz, with a fast slew rate. Two phono sockets are provided for stereo line input, plus an option for microphone. Adjustable gain is achieved with built-in control knob. Complete with public domain disk containing sound sampling applications / utilities.

**ONLY £29.95**

## TRACKBALL



Excellent new high performance trackball, directly compatible to any Amiga or Atari ST. Operates from the mouse or joystick port. Super-smooth, accurate and versatile - you probably won't want to use a mouse again after using this Trackball! Total one-handed control. Top quality construction and opto-mechanical design, delivering high speed and accuracy every time. No driver software needed!

**ONLY £29.95**

## NEW! A500 INTERNAL 3.5" REPLACEMENT DRIVE

Fully compatible. Kit includes full fitting instructions ..... £ 41.99

VIDI-Amiga video digitiser package inc. VIDI-Chrome	£ 110.00
VIDI-Chrome Amiga colour frame generation kit from B&W images	£ 15.95
VIDI-RGB colour frame generation kit from B&W images	£ 64.95
MINIGEN Genlock Adapter	£ 95.00
KCS Powerboard Hardware PC Emulator with its own 1Mb of RAM on-board, 512K useable in Amiga mode	£ 229.99
Kickstart 1.3 Upgrade	£ 29.95
Amiga 500 Dust Cover	£ 4.95

### SOFTWARE

Deluxe Video 3	£ 84.95
Music-X 1.1	£ 99.00
AMOS	£ 37.50
HiSoft Lattice C	£ 199.00
Kind Words 2	£ 37.95
GFA BASIC V3	£ 39.95
Protext V5	£ 119.95
GFA BASIC Compiler	£ 34.95
Digitia Home Accounts	£ 23.95
Devpac 2.15	£ 44.95
Deluxe Paint 3	£ 79.95
Disney Animation Studio	£ 69.95

## NEW! Olivetti DM124C Outstanding 24 Pin COLOUR Printer



PROFESSIONAL QUALITY 24-PIN COLOUR PRINTING NOW AVAILABLE - AT AN AFFORDABLE PRICE!

Combining the advantages of advanced COLOUR output with the superior quality of Olivetti Professional 24-pin printing, the new DM124C represents excellent value for money! Consistent high quality is assured every time, with no ink excesses or pale lines at any speed. Peace Of Mind for trouble-free use is Guaranteed, with Olivetti's 12 Months On-Site Warranty cover!

- 200 cps output in draft, 50 cps in LQ mode; huge 40K buffer
- 7 Colour output; Graphics resolution up to 360 x 180dpi
- Complete with cable & 12 MONTHS ON-SITE WARRANTY

Olivetti DM124C Normal RRP: £ 389.95 inc.VAT  
**Evesham Micros ONLY £269.00**  
 Special Offer Price inc.VAT, Delivery & cable

- Automatic Cut Sheet Feeder available for only £ 79.95 -

## STAR LC10 SPECIAL OFFER

BEST EVER SELLING 9-PIN PRINTER NOW AVAILABLE AT AN EXCEPTIONALLY LOW PRICE! Providing unsurpassed paper handling, four excellent NLO fonts and a respectable print speed of 144/36 cps, the phenomenally successful LC10 represents terrific value at this price.

INCLUDES CONNECTION CABLE & 12 MONTHS ON-SITE MAINTENANCE **ONLY £129.95**

## PRINTERS Prices include VAT, delivery and cable

### EVESHAM MICROS SPECIAL OFFER!

All STAR Printers include 12 months On-Site Maintenance

Star LC 200 9-Pin Colour, 4 fonts, 180/45cps	£ 209.00
Star LC 24-10 24-Pin, 4 fonts, 180/60cps	£ 209.00
Star LC 24-200 24-Pin, 5 fonts, 200/67cps	£ 249.00
Star LC 24-200C 7 colour version of above	£ 289.00
Automatic Sheet Feeder for above printers (pls.state model)	£ 64.95
Star FR-10 9-pin including Colour Upgrade	£ 259.00
STAR XB24-10 INCLUDING COLOUR UPGRADE & AUTOMATIC CUT SHEET FEEDER for Only	£ 359.00
Citizen Prodotti-24 Professional 24-Pin COLOUR Printer	£ 269.00
Olivetti JP-150 Inkjet compact, powerful - exceptional value	£ 249.99
Olivetti JP-350 Inkjet excellent high speed 300dpi printer	£ 349.99
Olivetti DM100S 200/30 cps 9-pin, inc.12 months O/S/M	£ 115.00

## 3 1/2" Track Display Drive



High quality double-sided 3.5" floppy drive offering the full 880K formatted capacity per 3.5" disk. Features a special LED display which accurately shows the current track being accessed during any disk drive activity.

**ONLY £64.95**

There is no easy way to learn games programming, but you can cut a lot of the hassle if you start off with a language specially designed to do some of the nastier jobs for you.

**Jason Holborn** shows you the AMOS short-cut to success.



# So you want to be a games programmer?

AMIGA FORMAT

114

SEPTEMBER 1991

SO YOU WANT to be a games programmer eh? I'm not surprised. After all, who could resist the lure of the lifestyle that these seemingly super-human coders seem to enjoy. Fast cars, mountains of cash and, to top it all, you get to wear those silly shades that are standard equipment for every games programmer.

So what is a budding games programmer to do? You've got two choices. Either you can swot up on assembler language for about five years, analyzing every piece of code that comes your way, or alternatively there's Mandarin's AMOS. Badged as 'the Number One games creation tool', AMOS certainly looks like the answer to every coder's dreams. Like all things in life, however, the reality is somewhat less attractive.

Many people fall into the trap of thinking that AMOS will write your games for you. Unfortunately, this just isn't true. Just like an assembler or any other programming language, AMOS is nothing more than a tool that is only as effective as the coder that uses it. If you've got little idea of how a game ticks, then there's simply no way that you'll produce even a half-decent game in your first few weeks of AMOS programming. *Noughts and Crosses* maybe, but *Rainbow Islands 2*? Forget it.

What AMOS does deliver are the tools to make the process of games programming that bit easier. Previously, about 80% of the time a programmer spent coding a game was wasted

writing routines that might do little more than redraw the screen display and sprites or play music and sound effects on cue. AMOS takes away these boring tasks, allowing you to concentrate almost exclusively on the mechanics of the game itself.

To make things even simpler, AMOS includes a number of extra utilities that cover the many aspects of games coding. For starters, there's a powerful sprite editor that takes away much of the hassle involved in producing the objects that you'll want to have moving around the screen - the player's ship and attacking aliens, for example. There's also a Map Editor, which lets you create huge multi-screen levels that eat up a minimal amount of RAM - something that is important if your game is to run on a basic 512K Amiga.

Just about the only utility that AMOS doesn't offer is a music editor, but even this is covered with AMOS's powerful music conversion program. You can produce your music in any one of a number of commonly-available music packages and then have AMOS play the tune under interrupt while your game is left to run at full speed.

AMOS is most certainly an impressive piece of software, but it has only one limitation - you, the user. If you're prepared to put in a lot of hard work learning to use it, then go for it. If you expect the Amiga to do all the hard work for you, then steer clear. 

**THE STORY OF AMOS** starts in September 1988 with the launch of a game-creation system called STOS for the Atari ST. Created by French software developer Jawx and published by Mandarin,



it gave an unparalleled level of control over the ST hardware and sold like hot tuna.

Jawx had no plans to produce an Amiga version, but the success of STOS convinced Mandarin it would be a good idea. Chris Payne, the man in charge of the project, soon realised that the Amiga version could go an awful lot further if it used the Amiga to the full...

...so programmer Francois Lionet, one of the Jawx team, was set to tinkering and became a convert to the Amiga almost overnight. Since that day, Francois has concentrated his efforts on putting all the power of the Amiga hardware under AMOS's control.

AMOS was announced in 1989 and caused a stir among Amiga owners keen for an easy way to program, but as project co-ordinator Richard Vanner tweaked the quality the release was delayed. Only in July 1990 did AMOS finally go on sale, eight months after the first news of it was released.

AMOS proved its worth with four great little demo games (free with the system) and Mandarin intended to produce full-price games with AMOS. As far as we know none has ever appeared, though the top-selling educational package **Fun School 3** from sister label Database, was partly programmed in AMOS.

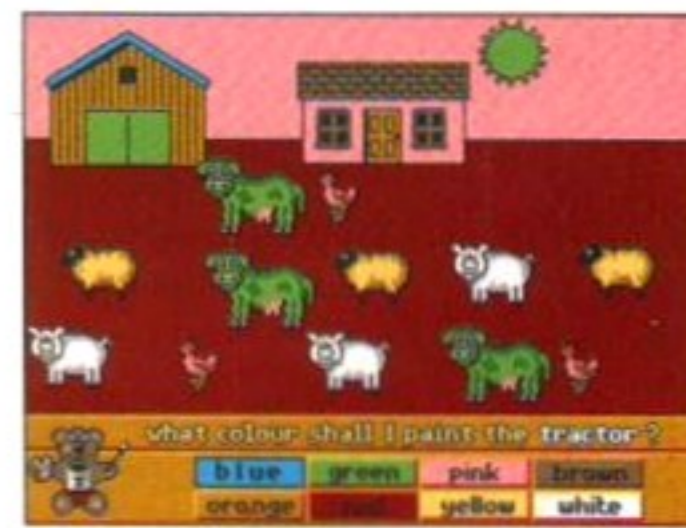

Anything you make with AMOS can be set up as a stand-alone program and distributed wherever you like. A flood of AMOS-built programs quickly appeared in the PD and there's now even a special AMOS



PD library with hundreds of disks on offer. Contact AMOS PD on 0942 495261. For some reason, there's heaps of educational stuff. AMOS seems to have tapped a rich seam of parents with good ideas who want to do it for themselves.

The latest update of AMOS has just arrived, along with a Compiler to speed up your programs and, most exciting of all, AMOS 3D.



Programmed by Voodoo Software, the guys behind the game *Xiphos*, the 3D system will let you create spectacular filled-vector games and demos. Now read on!

**BAD CRAZINESS IS** the best description of the way AMOS forces you to go about making a stand-alone program that you can pass to your friends. You have to include the RAMOS run-time module, which takes up masses of space, has to be obtained separately from AMOS PD if you're not a registered user and never quite seems to work properly anyway.

You may think that RAMOS does the job perfectly well as it is, but the advantages of a compiler have to be seen to be believed. If you're using AMOS to write software that you wish to share with your friends, give to any one of the AMOS-related PD libraries or even send into *Amiga Format* for publication on our Coverdisk, then a compiler is an absolute must. And now, at last, there is one!

Because the program no longer needs either the AMOS Interpreter or RAMOS to run, you can distribute your programming wares much more easily. Indeed, once it is compiled, it's perfectly likely that no-one would ever know that your programming masterpiece was even written in AMOS!

Probably the most striking feature of the *AMOS Compiler* is the extra speed that it gives your programs. Because the compiler converts your AMOS programs to high-speed machine code, programs are turbo-charged beyond recognition. In fact, it's all too easy to end up with a compiled program that actually runs too fast! In general, though, you can expect your programs to run at least two to five times their original speed.

**There is a belief** that compilers are terribly complicated beasts, but this most certainly isn't the case with the *AMOS Compiler*. Whether you're running it from the CLI or from within its beautifully-designed front end, you'll find *The Compiler* child's play to use. With its big, bright presentation and logical design, you'd have to have the intellectual capacity of a cornflake to go wrong.

Operating *The Compiler* is a pretty simple task. Once it's loaded into memory, all you need do is to tell *The Compiler* whether to compile direct to disk or to RAM, select 'Compile', give it the filenames of the source and destination files and you're away. Then in a matter of seconds your AMOS program is

If you've got AMOS, you need to know about this.

It promises to speed up your creations and make them into proper stand-alone programs at last.

**Jason Holborn** clicks the Compile button and sits back to see what happens...



Pretty isn't it! This is the main Compiler screen. Click on the 'Compile' gadget and everything is done for you automatically.

# The AMOS Compiler

Program compiler for AMOS ■ £29.99 ■ Mandarin

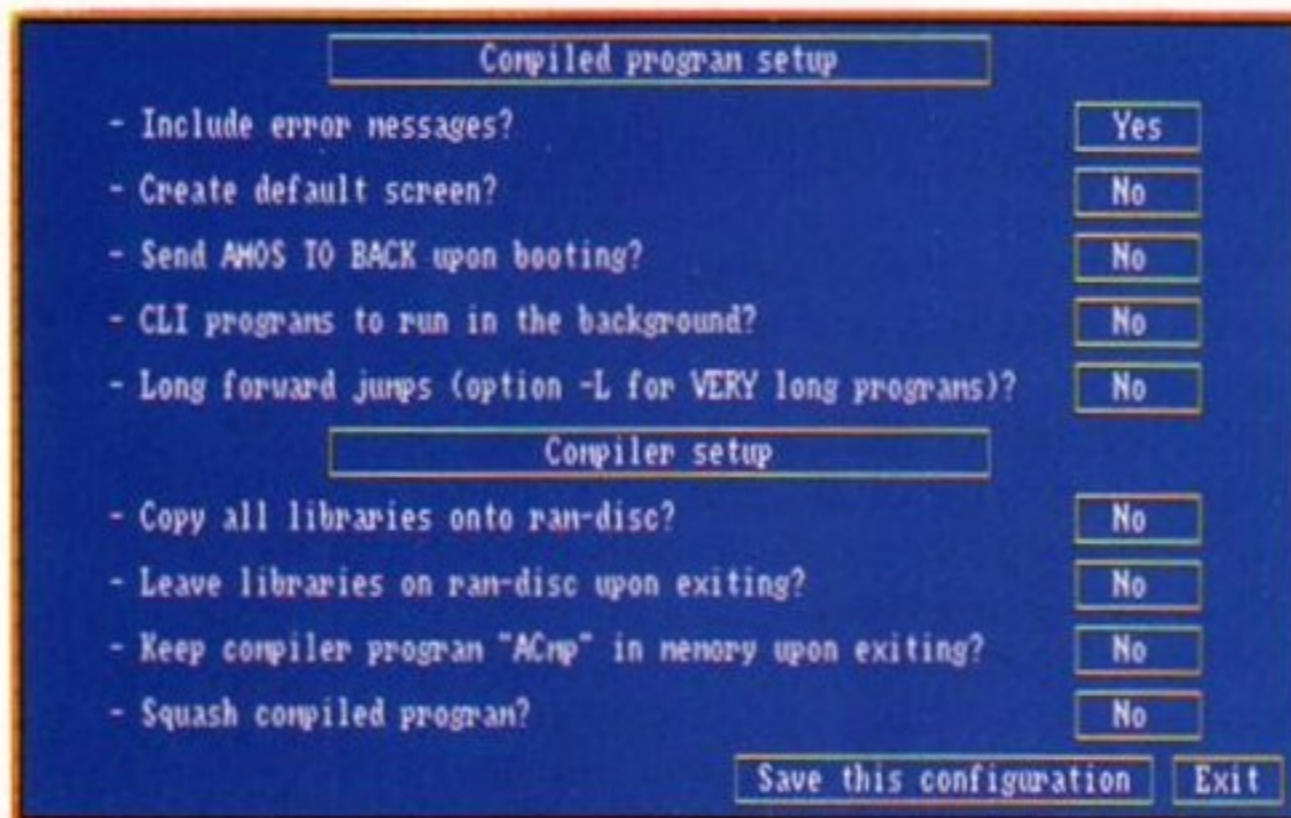

compiled into super-fast machine code. Once compiled, the resulting files still have a habit of being rather large in size. To combat this, *The Compiler* has built into it some very fast and very effective compression algorithms that crunch the program down in size. The crunched programs automatically decompress on loading, although this has the inevitable side-effect of slowing things down somewhat.

**Customise your compiler to suit your own needs.**

**The AMOS Compiler**  
£29.99 Mandarin  
0625 859333

It's been a long time coming, but I can safely say that the wait has most certainly been worth it. Mandarin have managed to produce a compiler system that is not only powerful, but is also easy to use. If you've sussed out how to use AMOS, then there's no question of whether or not you could get to grips with the *AMOS Compiler*. Just a couple of mouse-clicks are all that is needed to set the compilation process in motion.

Should you buy it? Well, put it this way – if you're an AMOS owner, then you'd be a fool not to. The advantages of having your AMOS productions in a compiled form most certainly outweigh the cost.

And even for those people who don't have AMOS, the release of *The Compiler* has suddenly made AMOS a much more attractive proposition, because it finally lets you create applications and games that actually look as if they were written for the Amiga. Who knows, perhaps now we'll finally start seeing AMOS-produced games appearing in the Screen Play section of the magazine!

## WHAT'S NEW IN AMOS 1.3

Supplied with the *AMOS Compiler* is a special Updater disk that upgrades your AMOS master disk to the latest release, Version 1.3. The Updater operates on working copies of your AMOS disks and converts them to the new version automatically. Written by Gary Symons, the upgrade includes several new and improved features that push AMOS still further. Here's a rundown of what's on offer.

**IMPROVED MULTI-TASKING SUPPORT** – AMOS is now multi-tasking friendly, allowing you to run other programs simultaneously. This is supported by three new AMOS commands.

**LOAD AMOS FROM A DIRECTORY** – Hard disk owners will be pleased to know that AMOS can now be installed anywhere on a hard disk.

**INTERLACE SUPPORT** – Now you can open both high-resolution and low-resolution interlaced screens with SCREEN OPEN's new HIRES option.

**REQUEST** – A new REQUEST command generates a requester which can be handy for getting quick yes/no answers from your program's user.

**FASTER GRAPHIC COMMANDS** – Gary Symons' new turbo-charged routines speed up both Bob and Screen copy operations considerably, making your games run much faster.

## AMOS Compiler

### SPEED ●●●●●

If you thought Amiga compilers were slow, then you're in for a pleasant surprise.

### DOCUMENTATION ●●●●●

You don't really need the manual, but it contains everything you need to know.

### ACCESSIBILITY ●●●●●

Load it up, click on compile and that's it. Compiling programs has never been so easy.

### FEATURES ●●●●●

Perhaps not as comprehensive as the techies would like, but it does the job well enough.

### VALUE ●●●●●

At £30, the AMOS Compiler is dirt cheap. What else could you buy for that kind of money?

AMIGA  
**(Verdict)**  
FORMAT

**85%**

When AMOS was released, the most ambitious aim was the addition of a 3D games programming system for it.

Now, finally, the ambition has been realised. If you've ever wanted to create your own 3D worlds, this is your big chance. **Jason Holborn** shows you the way.

# AMOS 3D

3D programming system ■ £34.99 ■ Mandarin

IMAGINE BEING ABLE to create a 3D universe within your computer. It could be anything you like, from little more than a 3D aircraft skimming through space under your control, to a whole new world of virtual reality. Imagine too if you could create this universe yourself in just a couple of hours, with no crash courses in assembler language and advanced 3D mathematics required. With a copy of *AMOS 3D* and some good ideas, this dream can become reality.

Mandarin have delivered the tools to dream with the arrival of *AMOS 3D*, possibly the most exciting programming utility ever to hit the Amiga. Written by leading game developers Voodoo Software, authors of the 3D extravaganza *Xiphos*, *AMOS 3D* is an extension to the existing AMOS programming system that will allow you to create just about anything that requires complex three-dimensional graphics. Whether you're hoping to create *StarGlider 3* or explore the exiting new world of virtual reality, *AMOS 3D* gives you the power.

*AMOS 3D* consists of two totally separate modules. The first is an extension to AMOS that adds no fewer than thirty new commands to the already impressive command set of the programming language. These new commands allow you to pull together your 3D universe, move around it and even animate the objects within it. The second module is a powerful 3D

object modelling program that makes the process of creating 3D objects simplicity itself.

The heart of *AMOS 3D* is *OM*, a sophisticated solid Object Modelling program that is used to create all the objects that you wish to use within your programs. Without this all-important utility the *AMOS* extension is virtually useless, so you can expect to spend an awful lot of time sitting in front of *OM*.

Using *OM* is a little daunting at first, but despite its complexity you quickly come to understand its way of working and creating objects becomes an absolute joy. Until then, though, it's well worth taking time out to at least read through the tutorial in the manual. That should be all you need.

Objects are created within *OM* by building them up using five basic shapes or 'primitives'. These Lego-like building blocks can be modified in any number of ways to create the object you require.

Obviously in their basic form the primitives may not quite be what you're after, so you'll be pleased to learn that they can be modified in an almost infinite degree to suit your own particular needs. You're still restricted to the basic dimensions of the object (you can't warp a flat surface, for example), but you can pull out points, expand and shrink faces, scale and rotate the object to your heart's content.



At any time you can view your object in zoom mode.



Two objects can be edited simultaneously.

**AMOS 3D**  
£34.99  
Mandarin Software  
0625 859333

Some quite complex objects can be created by combining primitives to form larger objects. In theory, this should allow you to create objects of infinite complexity, but the reality is somewhat different. For starters, a restriction has been placed on the number of primitives (or 'blocks' as *OM* calls them) that a single object can contain. I managed to create a fairly hefty object from a maximum of eight blocks, which hardly leaves much room for creating very complex objects.

To avoid problems, it's well worth planning out your 3D objects before you try to create them within the object modeller. You may end up being able to cut out a few blocks by modifying existing ones. Not only will this give you greater room for manoeuvre, but also your programs will run faster.

## 3D BY COMMAND

The workhorse of *AMOS 3D* is a language extension that contains no fewer than thirty new commands designed specifically for the manipulation of 3D objects. Here's a rundown of some of the more obvious commands on offer (note that all start with the prefix 'Td').

- Td DIR** – Sets the directory that AMOS must use to read in 3D objects created within *OM*.
- Td REDRAW** – Redraws all visible 3D objects and any background.
- Td LOAD** – Loads a 3D object into memory.
- Td OBJECT** – Invokes a loaded object and displays it at a given position in 3D space.
- Td MOVE** – Moves a 3D object by either an absolute or relative value.
- Td FORWARD** – Simply by specifying which direction the object is pointing, *Td FORWARD* pushes the object in that direction at a given rate.
- Td SET ZONE** – This command defines an invisible 'zone' around the object which is used for collision detection between 3D objects.
- Td COLLIDE** – Checks for a collision between two specified objects.
- Td ANIM** – Animate your objects by pulling out a point by a given amount.

The demo of *AMOS 3D* shows off the kind of things it can do. The disk and the Amiga on the right, for instance, are good examples of using surface detail.

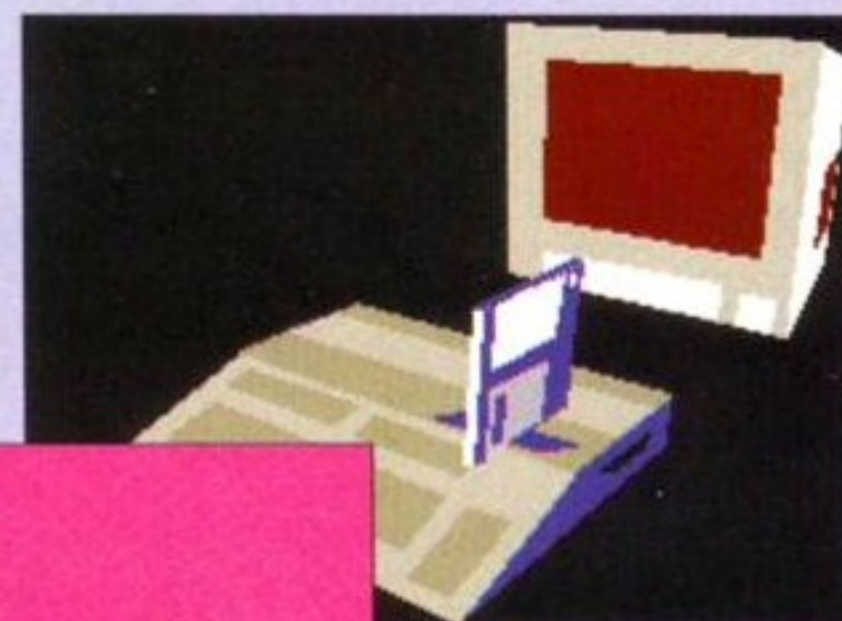



Although all the blocks have been merged, you can still edit individual blocks.

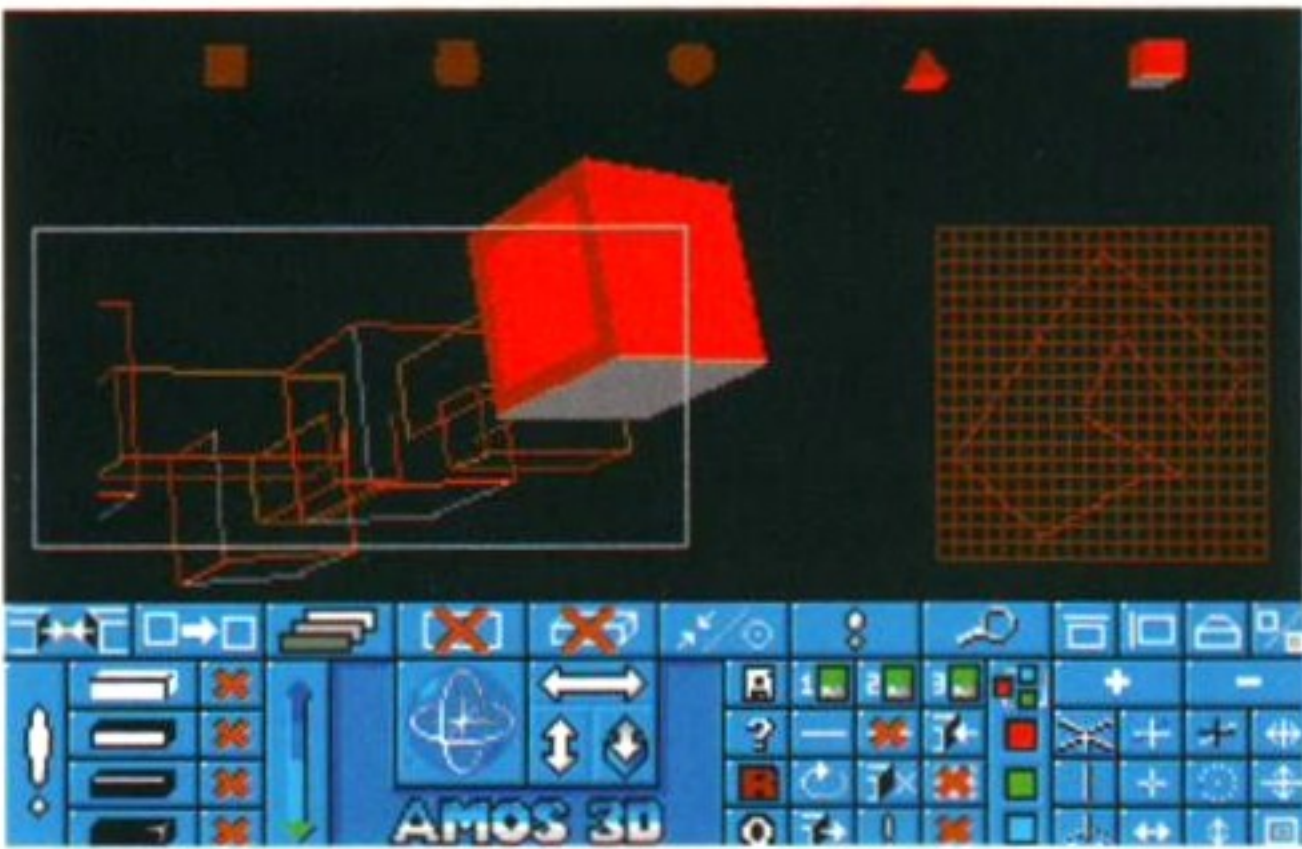

The surface detail editor in action. Note the grid on the right-hand side.

Another powerful feature of *AMOS 3D* is its unique Surface Detail facility. Using up to four colours you can etch a pattern onto any face of any object. If you use colour zero, you can even create transparent 'holes' within a face, allowing you to actually look into and even through a 3D object.

Clever use of surface detailing can create the illusion of a far more complex object than you have really created. And because surface detailing makes extensive use of the Amiga's Blitter, you can achieve much greater speed with decorated objects than you could by attempting to achieve similar results using lots of blocks. Indeed, if surface detailing is used effectively, the resulting object can look as if it is built up of many smaller primitives. As always, experimentation is the key.

**The AMOS Interpreter is the basic AMOS programming language and is required to use both AMOS 3D and The Compiler. £49.95 Mandarin Software 0625 859333**

## CREATING A SIMPLE OBJECT

Despite the fact that all objects must be created from five fairly simple graphic primitives, a little bit of experience and a lot of experimentation is all you need to start crafting some quite complex 3D objects. Some of the more complex shapes may need to be created by combining multiple objects, but on the whole the primitives will suffice.

The jet aircraft below is a prime example of a fairly complex 3D object that could be created within a matter of minutes. It consists of just two basic shapes, both of which were crafted from the cube primitive. The wings were created by stretching out a cube and then flattening it to form the basic shape. Then, simply by selecting the left most face, the wing was shaped by pulling the edge of the face to the right. Once this was done, the finished wing was then stored in one of the temporary 'shelves'.

The fuselage was the simplest object to create. The nose cone was created by flattening a cube on one side to produce a sort of wedged shape. This was then attached to a stretched cube. Once all this was done, it was only a matter of attaching the wings to the fusilage to produce the final jet. Clever eh!

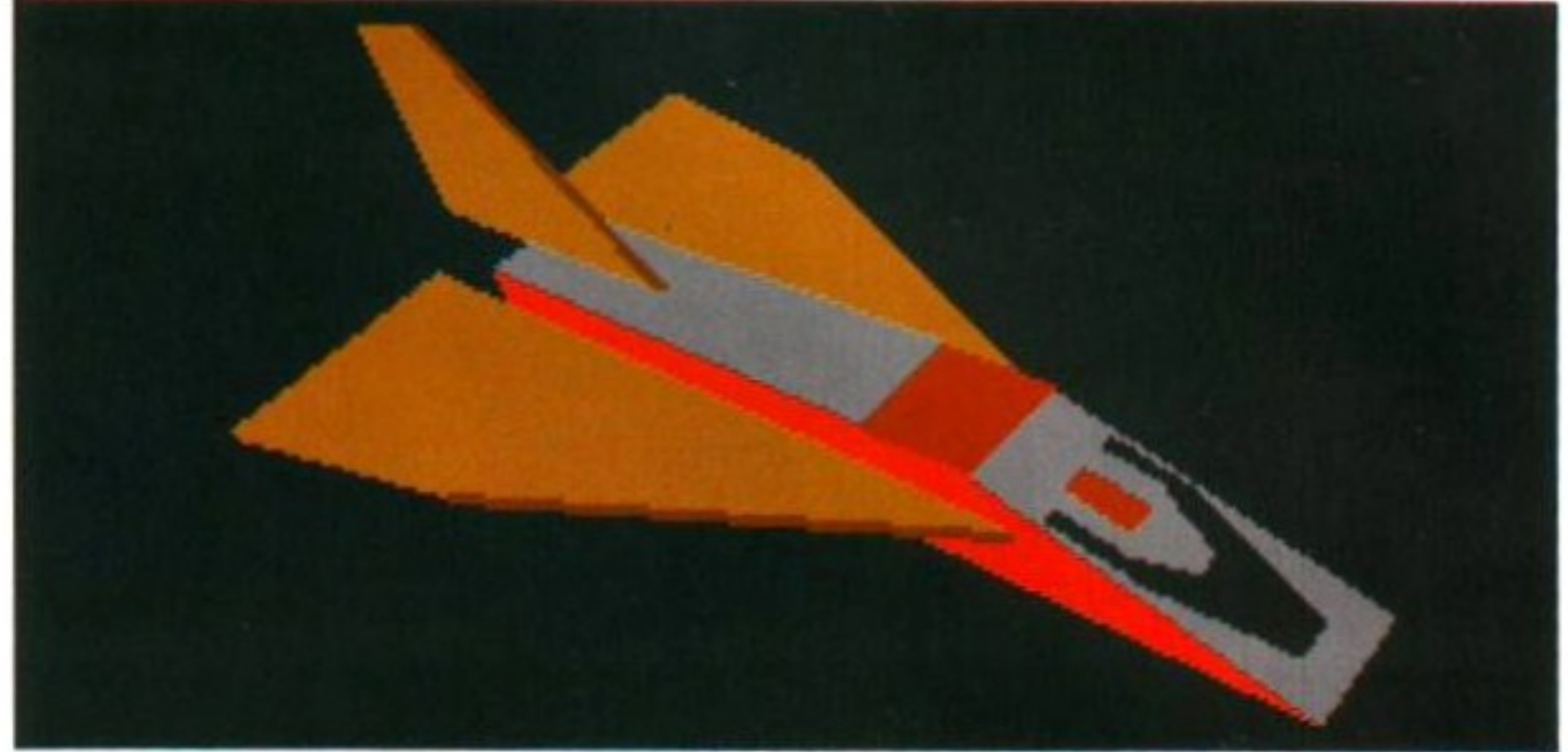

*AMOS 3D* certainly won't put professional 3D programming teams like Argonaut Software, Realtime and The Assembly Line out of a job, but it's a revolutionary piece of software nonetheless. Up until now, the likes of you and I could only dream of writing games that utilise 3D graphics, but *AMOS 3D* has truly delivered the tools to make this possible.

You may find working with 3D graphics rather confusing at first, but after little more than a few hours you should be churning out 3D demos at a blisteringly rate. The combination of what is undoubtedly one of the friendliest 3D object editors ever developed and a very powerful language extension makes *AMOS 3D* a virtual must for AMOS programmers. Even if you don't own AMOS, perhaps now is the time to finally take the plunge. ☺

### AMOS 3D

<b>SPEED</b>	●●●●
The 3D is not the fastest and smoothest I've seen, but it rattles along at a good enough rate.	
<b>DOCUMENTATION</b>	●●●●
The manual is very clear and easy to read, but then it definitely needs to be.	
<b>ACCESSIBILITY</b>	●●●
You won't have problems if you read the manual, but even then it takes some getting used to.	
<b>FEATURES</b>	●●●●
Packed with features, <i>AMOS 3D</i> is rather an impressive achievement.	
<b>VALUE</b>	●●●●
If you've already got AMOS, then it's great value. If not, a total of £85 is still not at all bad.	

AMIGA Verdict 82% FORMAT

## AT THE HEART OF THE SYSTEM: THE OBJECT MODELLER

The *AMOS 3D* Object Modeller is a fairly simple program to use once you've sussed out what all those icons do.

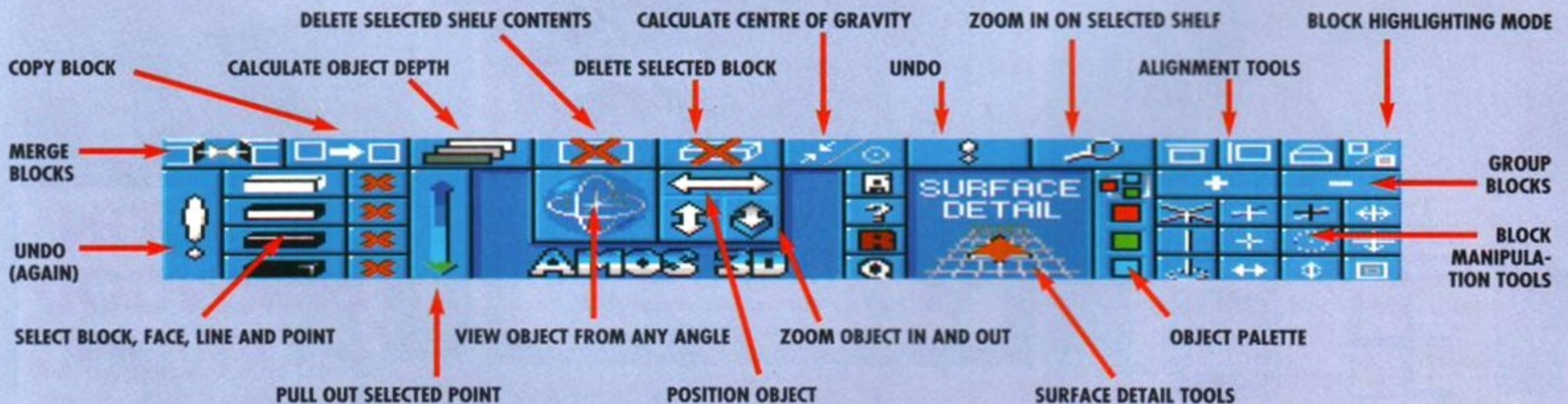

# You deserve the best!

## Now you can get the best... with PEN PAL!

A superb package, with immense power, to fulfil all your word processing requirements and... it includes a Database! It's all so easy to use, you probably won't need to refer to the extensive 250 page manual too often.

Whilst working, you can open up to four documents simultaneously (memory permitting), search and replace; cut, copy and paste; check your spelling with a 100,000+ word dictionary. You can import your favourite IFF/HAM graphics, from programs such as DPaint II or Clip Art files in various sizes and colours. You can automatically flow text around graphics in any Workbench compatible font (there are over 200 available styles), in different sizes and colours to suit your design... even as you type. All this from a word processor and... Much, Much, More!

As you can see, this is not just any ordinary word processor! Full Page View with position, edit and creation of graphic objects. Mail Merge using the built in database and forms designer. Creation of templates for complex reports, into which the database can be merged.

Operating with 32 fields per record, and 32,000 records per database with a fast sort of 1000 records in less than 5 seconds this is a *real* database.

*Pen Pal requires an Amiga 500/1500/2000 or 3000 with a minimum of 1megabyte of available memory.*

# Pen Pal

When...you deserve the best!

## £79.95



"...its handling of graphics is unsurpassed: Pen Pal is the only program I tested that will automatically wrap text around graphics..."  
*Amiga World...Jul. '90*

"...without beating around the bush Pen Pal is very special..." - "There is little to fault Pen Pal and it deserves to do well."  
*Amiga Format...Dec. '90*

"...I am extremely pleased with your product especially the Graphic Capabilities within the Word Processor. Having the Database on the same disk has made PEN PAL the best program I have..."  
*D.S.B., Plumstead, LONDON*

"...Please let me tell you how amazed I am at how EASY IT IS TO USE PEN PAL. The manuals supplied are very informative and very clear..."  
*P.S.S., Clifton, NOTTINGHAM*

"...A most excellent piece of software..."  
*E.P.H., Strathclyde, SCOTLAND*

**Gordon Harwood Computers**  
New Street  
Alfreton  
Derbyshire  
DE5 7BP.

Dear Sirs,

First! I am writing this letter using "Pen Pal". Normally I do not correspond with computer companies, but this time I had to make an exception.

I have been looking for a program that I could use to create colourful letters, useful forms, and effective business graphics. I have purchased several Amiga word processors whose ads made great claims as to their capabilities. After using these programs, however, I found that the ads were only hype! I soon began to feel that no program would do what I wanted to do.

Recently I saw your program "Pen Pal" on my dealer's shelf. According to the package I thought that I might finally be in luck. Although I purchased the program, I was afraid that in reality it would not do everything the package said it would do. As soon as I got home from the computer store I fired up the program on my computer. Without even reading the manual I was soon creating documents with colour and pictures. As you can see from this letter, I have become pretty good at your program's graphic capabilities.

One pleasant surprise I had was to discover that Pen Pal has a built in database manager. I find that I use this database almost as much as the word processor. I have entered my Christmas mailing list, video tape library, and cooking recipes in as databases. When I send Christmas cards this year I will use Pen Pal to print the mailing labels. I am designing my own Christmas cards in Pen Pal including some pictures I drew in a paint program. I plan to use Pen Pal's mail-merge feature to merge my mailing list names with the card to make each one personalized.

Thank you for making this program available.

Mr. Richard Goodwin

Man's (and Woman's) Best Friend

**Pen Pal Order Line**  
**0773 836781**  
Pen Pal is also available from good computer stores everywhere!

**FINANCIAL REPORTING COMPANY**  
Financial Report to Division Managers

OPERATING EXPENSES	1987	1986	1985	1984
Cost of sales	286,170	28,180	382,258	30
Selling, general, and admin.	264,429	32,188	675,948	165
Research and development	46,549	14,875	89,467	26
Income from operations	312,304	112,531	585,386	285
Interest income	7,347	5,232	421,812	285
Income before taxes	382,048	117,763	1,007,200	570
Provision for taxes	112,580	54,800	217,580	57
Net Income	190,348	62,963	789,620	513
Net Income per share	58.17	18.86	256.870	128.58

... and they are better than expected!

In the first quarter of 1988 each division took advantage of strong economic conditions in their respective territories to post sales figures well in excess of their goals.

Trade Distributors...

**SDL**

**Precision Software**

**CENTRESOFT**

**HBM HB MARKETING**

Pen Pal is supplied into the UK through...  
Gordon Harwood Computers New Street Alfreton Derbyshire DE5 7BP  
Telephone: 0773 836781 Facsimile: 0773 831040

**GORDON HARWOOD HARWOOD HARWOOD**  
*Computers*

● **Reviews of over 100 games** will help you decide what to buy

● **Tips, cheat modes and advice for over 100 games** can help you out if you're stuck

● **Maps for 12 big games** show you the way to reach the end

● **Complete solutions and playing guides** will take you further than you've ever been before

● **Stuck on an older game?** This is the only place you'll find the answer!

**All these games reviewed, tipped and hinted:**

Aaargh!, APB, Arkanoid, Austerlitz, Barbarian, Batman the Movie, Battlehawks 1942, Battle Squadron, Beach Volley, Bloodwych, Bombuzal, Castle Master, Chase HQ, Conqueror, Continental Circus, Corporation, Cybernoid I and II, Denaris, Double Dragon, Drakkhen, Dungeon Master, Elite, Escape from the Planet of the Robot Monsters, Eye of Horus, Federation of Free Traders, Fighter Bomber, Flood, Fusion, F-29 Retaliator, Gemini Wing, Ghouls 'n' Ghosts, Goldrunner, Hard Drivin', Hawkeye, Helter Skelter, Hero's Quest, Infestation, Interceptor, Interphase, Jumping Jack Son, Kick Off 1 and 2, Klax, Laser Squad, Lost Patrol, Menace, Millennium 2.2, Nebulus, Neuromancer, New Zealand Story, Ninja Warriors, Omega, Pipe Mania, Platoon, Player Manager, Powerdrome, Rainbow Islands, Rick Dangerous, Robocop, Rock, 'n' Roll, Rotor, R-Type, Silkworm, Sim City, Starglider 1 and 2, Strider, Stunt Car Racer, Supercars, Switchblade, Three Stooges, Thunderblade, Untouchables, Venus the Fly Trap, Vigilante, Wicked, Wizball, Xenomorph, X-Out, Xybots

**Complete solutions for these games:**

Batman - The Caped Crusader, Cadaver, Damocles, Dragon's Lair, Future Wars, It Came from the Desert, Kult, Operation Stealth, Shadow of the Beast I and II, Space Ace

# Buying games? Playing games? **You need this!**

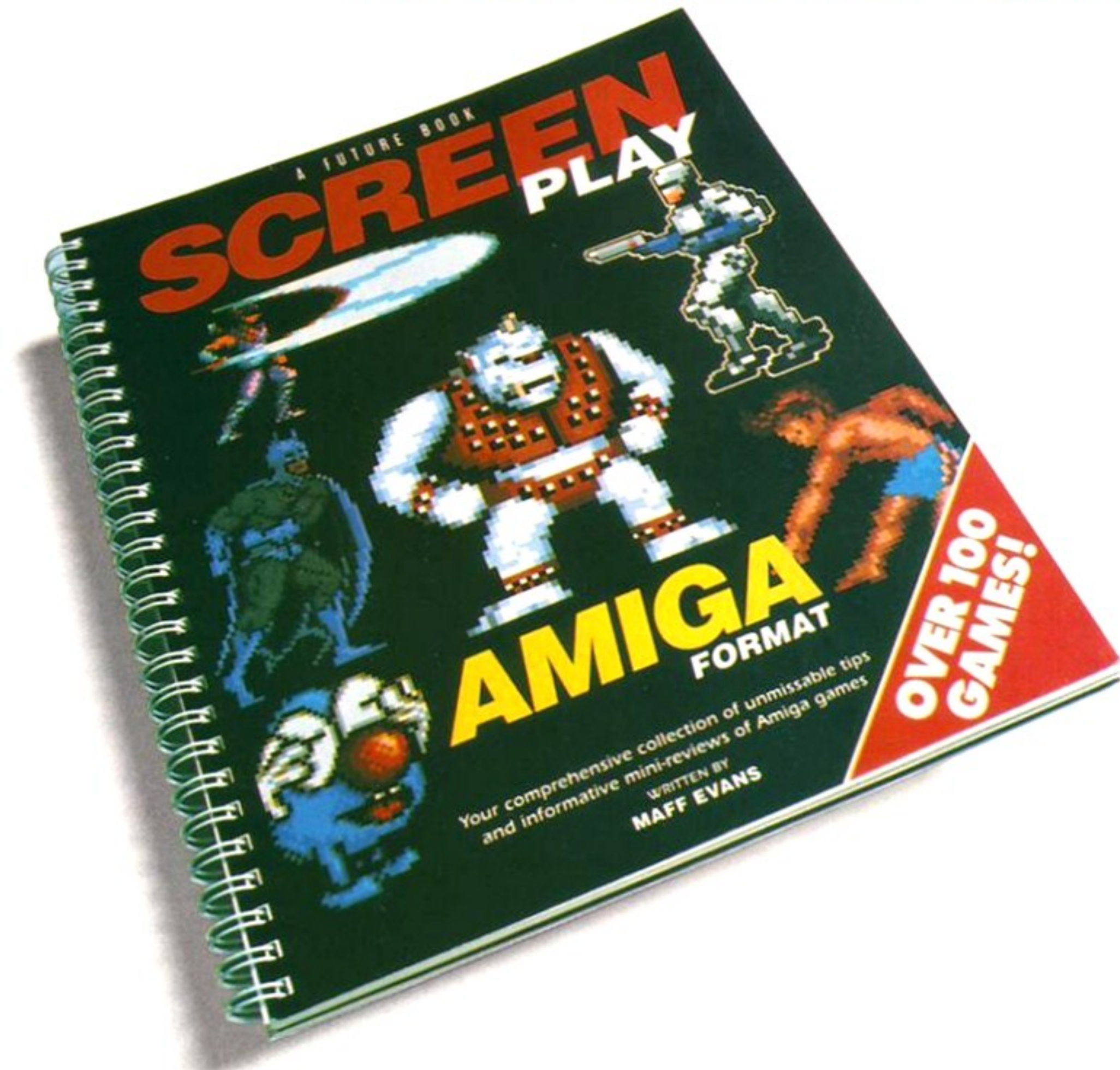

Lovingly constructed by Amiga Format Gamebusters supremo **MAFF EVANS** and costing only £9.95, this 162-page tome is the vital accessory for anyone who's serious about their games. Get it now!

## Order form

I would like to order \_\_\_\_ copy/copies of SCREEN-PLAY at the price of £9.95.

(please add £1.45 per copy to cover p&p.)

If paying by cheque please send payment with this order form in a sealed envelope to:

**AMIGA FORMAT SCREEN PLAY book  
FREEPOST  
Future Publishing Ltd,  
The Old Barn,  
Somerton,  
Somerset TA11 7BR**

No stamp required if posted in the UK  
Please allow 28 days for delivery

Name \_\_\_\_\_

Address \_\_\_\_\_

Post Code \_\_\_\_\_

Telephone \_\_\_\_\_

I enclose a cheque/PO for £ \_\_\_\_\_

Please debit my Access/Visa card: (Delete as appropriate)

My card no is: \_\_\_\_\_

Expiry date: \_\_\_\_\_

Signature \_\_\_\_\_

Structured drawing programs enable you to output your pictures at the highest resolution your printer can handle and impressive results can be achieved if you use the right program. **Marcus Dyson** takes a look at a new runner in the field.

# Design Works

Structured Drawing Package ■ £99.95  
New Horizons

**COSTING MORE THAN** your average paint package, offering fewer features and at the same time being more difficult to use, structured drawing programs do not seem to have much going for them at first inspection. Why would anyone splash out for a package that apparently offers less for more? The answer lies in the way that structured drawings are made up.

Instead of the picture being composed of hundreds of little coloured dots, it is made of separate objects which are stored in the document as pure mathematical information. Because the positions of the points are stored as co-ordinates and the lines as directions, this type of program is sometimes known as a vector drawing program. It's the same kind of system as 3D games.

When the Amiga comes to output the image, it tells the printer where the points are that make up a shape and what thickness and colour the lines are that join those points together. The printer then goes about drawing the shape at the highest resolution it is capable of: so if the picture is greatly enlarged, the lines and curves still stay very smooth.

Structured drawing software for the Amiga is not incredibly common. Potential buyers of a pixel paint package would have to decide between *Deluxe Paint IV*, *Photon Paint 2*, *Spectracolour* and *DigiPaint 3*, to name just the options that offer HAM, whereas Amiga owners wanting a vector drawing program had, until very recently, Hobson's choice.

Until now *Professional Draw 2* from Gold Disk was the only structured drawing software for the Amiga worth a mention: but now a contender in the shape of New Horizons' *Design Works* has emerged.

**Design Works**  
£99.95 Silica  
081 309 1111

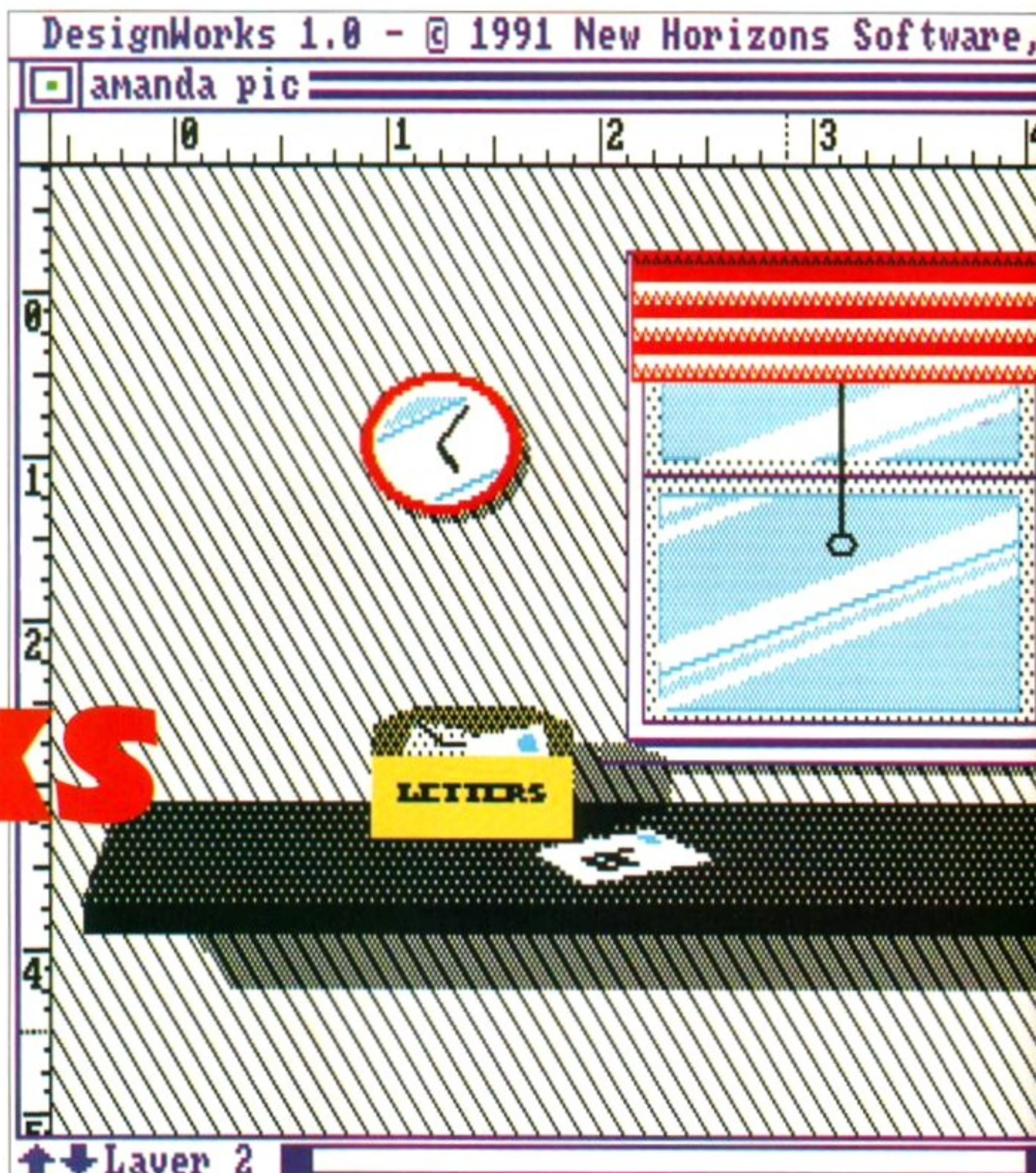

*Design Works* loads into an unexpanded Amiga 500 with no problems, aside from a good few Program disk-Workbench disk swaps. Once loaded the program runs quickly and smoothly, but there is not a lot of space left for the creation of large pictures. Adding an additional disk drive without expanding the RAM causes the program to refuse to load.

A nice feature of the package is that it can be launched by double-clicking on the icon of any document that has been created using it. Many Amiga applications deposit an icon with any document file they create, but few can actually load the program by selecting the document in this way. On the Apple Macintosh all applications can be opened this way, and

programmers should endeavour to make Amiga programs work in the same way if the machine is ever to rival the Mac's friendliness.

Once you are up and running, all of the functions you would expect from any decent drawing program are displayed in the tool palettes at the top right of the screen. These windows can also be closed to enable more of the picture to be seen.

As well as the usual shape- and polygon-drawing and freehand tools, there are palettes to control the pen colour and fill colours. Changing the pen colour will alter the colour of the lines that things are made up of while the fill alters the colour of the flood that automatically fills every shape that is drawn.

## SETTING A BAD EXAMPLE

Whenever you buy a graphics program, be it a pixel paint package like *Deluxe Paint IV* or a CAD program like *AutoCAD*, you will find, if you look hard enough, that somewhere on the disk there are some examples of what the program can do. These documents are there to give you ideas and encourage you to learn how to use the program so that you too will be able to do similar or better things. But also they are so the programmers can show off a little bit, since they know how the program works better than anyone else.

But if you load up the examples that come with *Design Works*, you will see images of the quality shown at right. Not exactly a Picasso, is it? If this is the best they could get out of it, what are you to expect?

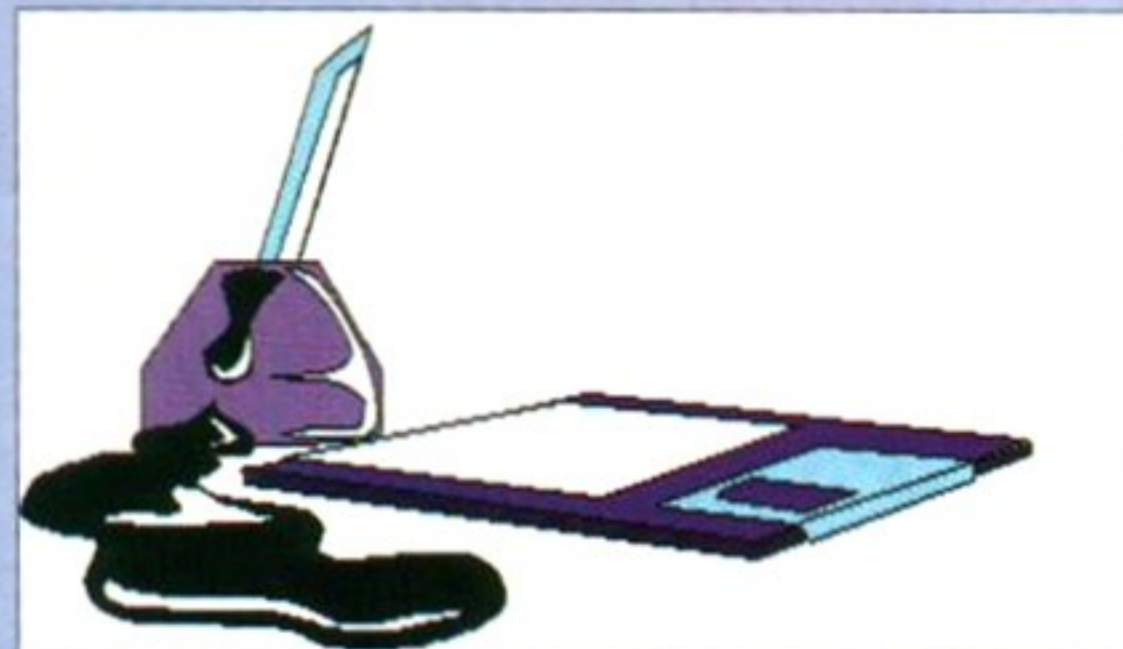

Some of the Example art that comes with the program. It doesn't really inspire confidence, does it?





The colour and pattern of a fill can be easily changed by selecting an object and clicking on the fill palette.

*Design Works* supports HAM and will allow you to create drawings in up to 4,096 colours, but will only display things on screen as the nearest available screen colour. RGB (red, green, blue) or HSB (Hue, Saturation, Brightness) sliders are used to set up a colour which will then be displayed in the handy palette on screen. If you need more colours than there is room for in the palette, don't worry: colours that have been used can be replaced without affecting the colour of shapes that were drawn using those colours. But memory restrictions prevent changing the screen colours in a half-Meg machine.

One of the first things newcomers to structured drawing should know is that once something is on the page, it can still be changed, no matter how long ago it was put there. Parts of the picture that are behind other elements can be brought to the front and shapes can be changed almost as easily as the colours can. If you want more of one thing in your picture you can simply duplicate the first one you drew and resize and recolour the subsequent copies.

Even after the picture has been saved to disk, it can be loaded back into memory and played around with. This is another advantage of vector over bitmapped drawings. Most of the program's functions are available through

## DRAWING BY NUMBERS

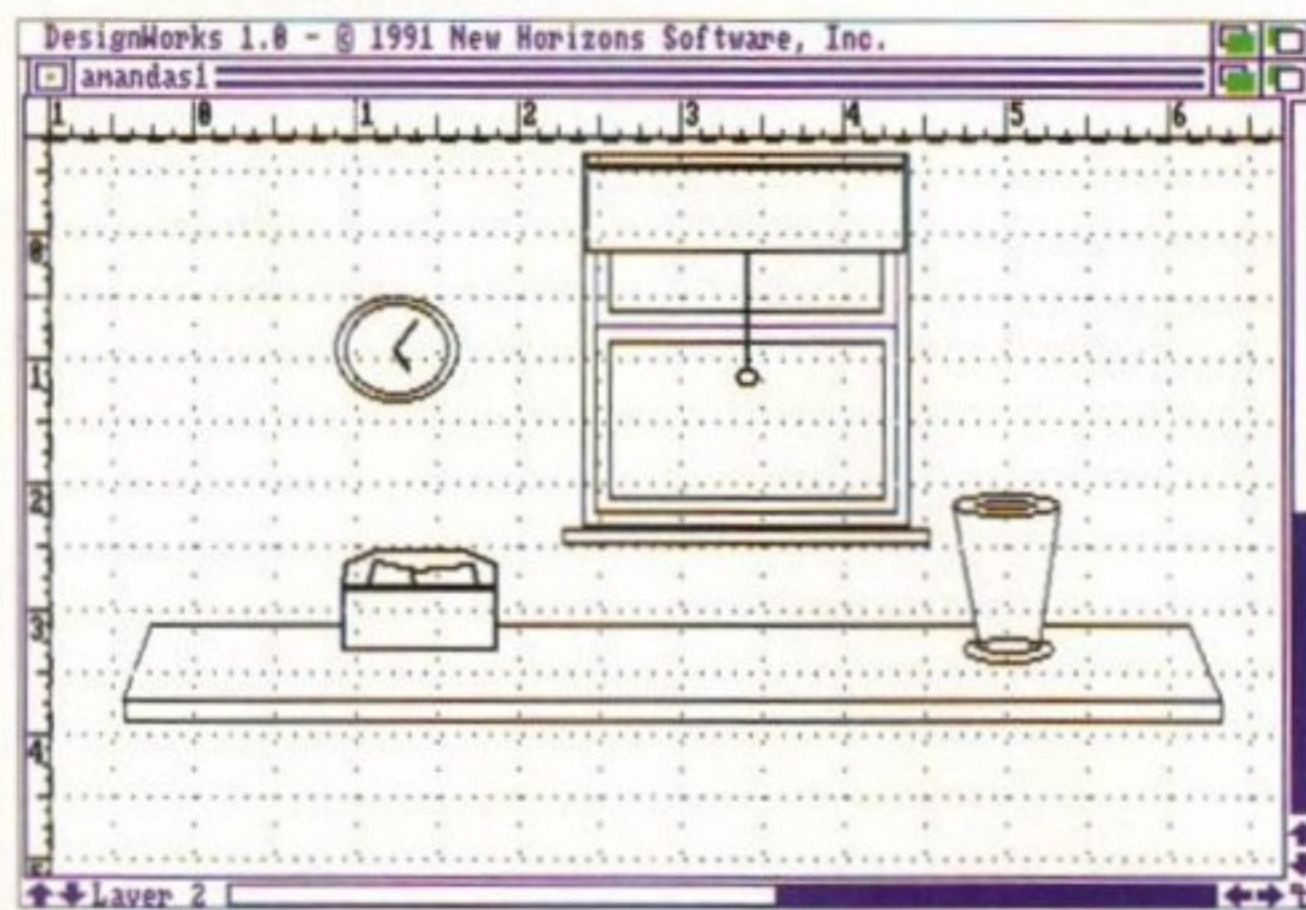

To make a structured drawing, you start with the outlines of things in simple black-and-white. At this point colour is irrelevant, but the shapes have to be more or less correct. *Design Works* features a grid to help you get things lined up: you can define the size of the grid and switch on a 'snap to grid' function to make sure things are exactly level.

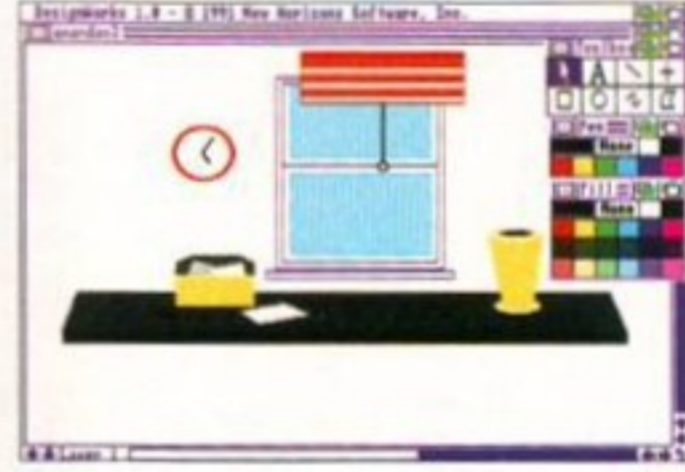

Once the shapes are sorted out, it's time to add some colour. This is done by selecting the object to be coloured, then clicking on a square on one of the palettes at the top right of the screen. The top

palette defines the pen colour and will change the colour of a shape's outline: the one underneath defines the colour and pattern of the fill. More colours are available than can be displayed at one time (4,096 to be precise), so it's just a matter of mixing a new colour over one you have finished using. Changing a colour in the palette will not affect objects that have already been drawn in that colour.

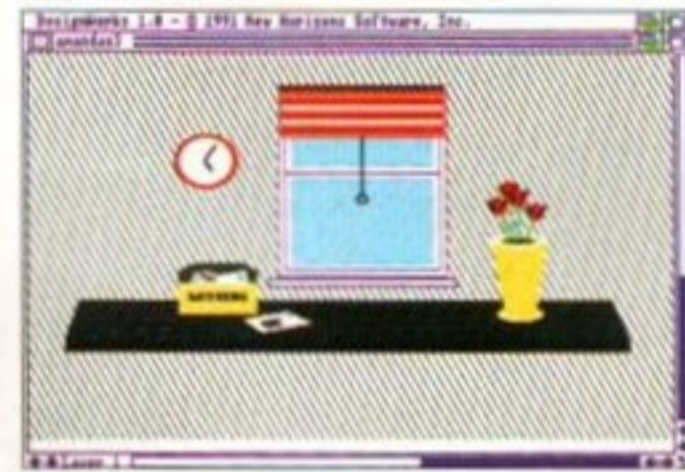

After the colours come the fine details. The wallpaper is just a filled rectangle placed behind all the other objects; the clock hands are created using the freehand drawing tool. The blind is moved into the correct position and has a pattern added to it. *Design Works* enables you to use text in your pictures, but cannot resize it, so you need to have the right font at the size you want to use.

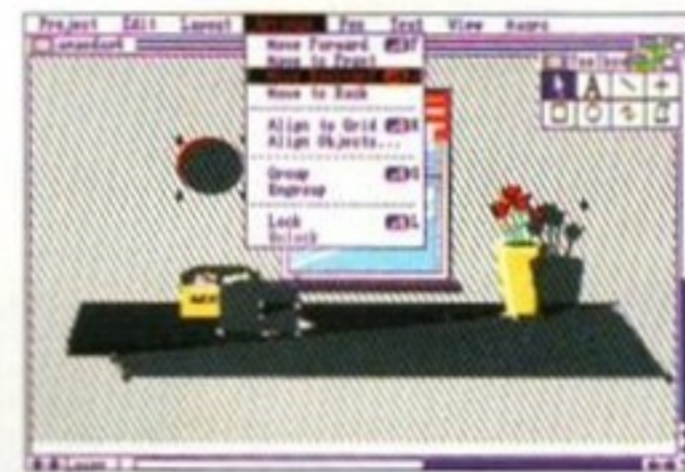

The lack of graduated fills can leave drawings looking a bit flat, but adding highlights on the windows and shadows can help them look a bit more realistic. Shadows are created by duplicating an object and making a dark fill for it. Then you use the Arrange menu to send the shadow back so that it is behind some things and in front of others. This is quite easy to do, simply because until you get it right it looks it looks very wrong!

the keyboard, which saves time on having to go up to the menu bar every time you want to change something. When something does have to be changed, the requesters are very clear, leading even the novice through such operations as setting Preferences or opening a document with the minimum of fuss.

*Design Works* is limited in its ability to manipulate text. Admittedly it can be rotated, but only through increments of 90 degrees. Making text flow around the path of a curve is not possible, and resizing text is limited to the sizes of fonts installed on your system.

At output stage the program looks for larger fonts and scales them down to improve the quality of the printed results, but this depends heavily on you having the required larger point sizes. Using outline fonts would probably improve this situation though.

Objects can also only be rotated through right angles, but this is less of a problem, since they can be drawn at the desired angle in the first place, or manipulated to it if necessary.

The other opportunity that New Horizons have missed is the failure to include graduated fills, or a blend function like the one in *ProDraw 2*. This means that all areas of colour end up being flat, or filled with one of the user-definable patterns, it can be difficult to give pictures any feeling of depth.

In its favour *Design Works* is fast and easy to use, which makes it suitable for the younger Amiga user, or for entry-level exploration of the structured drawing arena.

It seems strange that software which has several enhancements for AmigaDOS 2, the operating system of the mighty A3000, should not offer features that users of much more modest Amigas have come to expect from such a program. For the record, if you have Workbench 2, one such enhancement is the support of AREXX macros, which enable you to write short routines and assign them to a key, offering user definable keyboard shortcuts. This is all well and good, but I cannot help wishing that they had spent less time making it Workbench 2 friendly, and more time coding useful functions. *Design Works* is left as an entry-level program written with an extremely high-level machine in mind.

### Design Works

<b>SPEED</b>	●●●●
Very fast: even on an unexpanded A500 the program boots, loads and redraws quickly.	
<b>DOCUMENTATION</b>	●●●●●
The manual explains every feature of the program in a clear and concise manner.	
<b>ACCESSIBILITY</b>	●●●●
Using <i>Design Works</i> is just a matter of booting it up and giving it a go, totally simple.	
<b>FEATURES</b>	●●
No graduated fills and very limited text manipulation will consign this to beginner status.	
<b>VALUE</b>	●●●
It costs more than, for example, <i>Deluxe Paint IV</i> without delivering the kind of features.	

AMIGA  
Verdict  
71%  
FORMAT

# Mega Value GAMES PACKS Mega Value

## ARCADE CLASSICS

An amazing pack full of nostalgic arcade games including: Space Invaders, Asteroids, Pac Man, Missile Command, Breakout and Qix. Order code GP1.



£10.00

## ARCADE PACK 1

The first of our special arcade packs with shoot 'em ups and platform type games includes Paranoid, Galadria, Drip, Peters Quest, Drive Wars and Cosmic. Order code GP2.



£10.00

## ARCADE PACK 2

More brilliant arcade attacks with Tetris, Pipe Line, Air Ace 2, Organic Horror, Gore Blasters and Escape From Jovi excellent! Order code GP3.



£10.00

## BOARD GAMES 1

A mega compilation of classic board games includes Back Gammon, Five In A Line, Chess, Tiles, Flipper, Amigo, China Challenge, Master Mind, AmigaTron, Up and Down, Triangle and Triple Yacht Z. Order code GP4



£10.00

## CARD GAMES 1

If you like playing card games then this is the pack for you! Includes Card o Rama, Spades, Black Jack, Solitaire X, Klondike Solitaire, Canfield Solitaire and Cribbage. Order code GP5.



£10.00

## TRIVIA PACK

A mega compilation of trivia quizzes that will keep you occupied for hours! Includes thousands of questions on a variety of subjects. Includes Quiz, Hollywood Trivia, Trek Trivia, Star Trek Next Generation Trivia. Order code GP6.



£10.00

## ADVENTURE GAMES

Four excellent new adventures to take you into different worlds. Includes The Holy Grail, Golden Fleece, Midnight Thief and Dragon Cave with its 3D graphic display. Order code GP7.

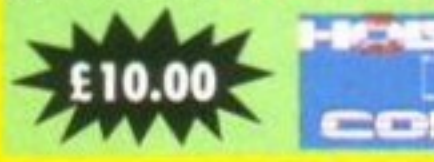

£10.00

## SPORTS PACK

This pack should keep you fit! Includes Tennis (1mb RAM), Down Hill Skiing and Car racing. Order code GP8.



£7.50

## MEGA GAMES MEGA PRICES!

- PSL1 - Space Blob is a brilliant platform cavern game. £3.00.
- PSL2 - Mr Dig, help Mr Dig collect the apples and kill the monsters. Requires 1MB RAM. £3.00.
- PSL3 - Q-Bold shoot blocks at the various random shapes descending on you. A Tetris variant. £3.00.
- PSL4 - Computer Conflict excellent speech and graphics in this all action arcade game. Requires 1MB RAM. £3.00.
- PSL5 - Subculture by Kevin Kendall a mega shoot 'em up. £3.00.
- PSL7 - Dizzy Lizzy an excellent game across between Pacman and Boulderdash. £3.00.
- ALP5 - Jungle Bungle adventure in the jungle mainly for children with excellent graphics, speech and animation. Requires 1MB RAM. £3.50.
- ALP6 - Pukado avoid the baddies and skull as you try to empty the screen of tiles. £3.50.
- ALP7 - 4 Way Lynx a 22 level puzzle game where the object is to connect a specified number of tiles to the main centre tile. Requires 1MB RAM. £3.50.
- ALP11 - Go Getter an excellent board game that will keep you occupied for hours! Guess whether your on your path the number on the next step is higher or lower than the one you are on, watch out for teleports and and bonus points. Requires 1MB RAM. £3.50.
- ALP16 - Reversi II based on the board game Othello. Requires 1MB RAM. £3.50.
- ALP17 - Dog Fight! upto 8 players can play this brilliant aerial shoot 'em up. Requires 1MB RAM. £3.50.
- ALP19 - X IT 50. A split screen shoot 'em up. £3.50.
- ALP21 - Quingo an excellent quiz game where you answer questions and play bingo. Requires 1MB RAM. £3.50.
- AMU13 - Bull Run an American civil war simulator. £3.00.
- AMU14 - Battle Mech a strategy war game between robots. £3.00.
- FAUG52 - PacMan 87. £3.00.
- FF194 - Moria the single player dungeon adventure game. Requires 1MB RAM. £3.00.
- FF336 - Car. A brilliant racing game. £3.00.
- PD90 - Tennis! and excellent implementation of the sport. Requires 1MB RAM. £3.00.
- PD79/80/81 - Star Trek by Twisted Images. Full graphics and sounds from the original Star Trek. Requires 1MB RAM and External disk drive. £9.00.
- PD215/216 - Star Trek by Agatron. Full graphics and sounds and animation from the new generation Star Trek. £6.00.
- PD233 - Holy Grail adventure that requires 1MB RAM. £3.00.
- PD234 - The Golden Fleece adventure. £3.00.

# £3 Mega Value SOFTWARE Mega Value

### EDUCATION

**AMP6** - Under 8's pack. The following 5 disks with an 'ALP' code are a DEJA VU Licenseware Product and are available as a pack for only £17.50 or individually for £3.50 each.

**ALP1** Colouring Book a good colouring book for young children. £3.50.

**ALP2** Arc Angel Maths a good math program that includes graphics to aid learning. £3.50.

**ALP4** Thinga Majig is a puzzle program with 24 built in puzzles to choose from. £3.50.

**ALP8** Work and Play (requires 1MB RAM) 3 excellent programs Funtimes Table, Let's Go Shopping for maths and Click Clock teaches a child to tell the time. £3.50.

**ALP10** Word Factory which is a games type environment that teaches spelling. £3.50.

**AMP5** Over 8's pack: 2 excellent map drawing programs of any location on earth, Evo follows the evolution of life, Chemistry Element Periodic Table includes with details and graphics of all elements, Unit Conversion is a program that allows you to choose all types of unit i.e length, time, weight, speed etc and then do conversions and comparisons between them, plus more! German Language Tutor, Speak and Spell Tutor, Study Aid Cards, Hermes Formula, Cloud, the weather, GEO Time, Gravity Simulator, FUNC2D, Gravity Well, Air Foil, Wave Maker and others. An excellent pack for only £12.50!

**PSL8** FUN TIME 1 a great educational offering aimed at children age 3 to 6. This disk is crammed with delightful tuition on many subjects: shapes, keyboard, clock and picture. £3.00.

**PSL9** FUN TIME 2 a great educational offering aimed at children age 3 to 6. This disk is crammed with delightful tuition on many subjects: money, seasons and mouse. £3.00.

### GRAPHICS

**AMP3** Graphics Pack 1. Mcad the excellent high resolution CAD package, ROT 3D drawing program, VDraw the painting program, RayTracer for creating amazing ray traced pictures. Also a disk full of graphic utilities: Clip It! allows you to clip any part of the screen and save to disk as a picture file, FilterPix allows manipulation of pictures with enhancers, edge definition, colour and size shifters, C64 picture converters, picture showlers, screen and window to disk savers, icon editors and icon converters (brush to icon, IFF to icon etc.). £8.50.

**AMP21** Graphics Pack 2. The Mse Mandelbrot explorer includes some excellent examples, a picture converter to convert Atari ST DEGAS and NEO to Amiga IFF, Apple MAC view and convert to IFF, PopColours pops up a colour palette, picture viewers: DPSSlide, SeeILBM, ShowHAM and IFFEXEC which allows a picture to be shown simply by double clicking on it. Also NewGetImage and Brush2C which convert IFF and Brush picture files to C code for inclusion in programs. Also for weird spaced out visual effects try PolyGon, VIZ and KAL all these allow you and your mouse to create amazing weird screen displays; PolyGon even allows colour cycle! A HAM scribble screen. DBW Render the raytracing package. Also in this pack is FBM. FBM is an image manipulation library. £8.50.

**PD502** - C Light. The Ray Tracing Program. £3.00.

### FONTS

**PSFF1** - Fletcher Font Pack 1 contains 66 multi coloured fonts on 6 disks for £15.00 compatible with all IFF font using programs.

**PD53/54/55/56** - Public Dominator font pack contains 50 single coloured fonts on 4 disks for £10.00 compatible with all IFF font using programs.

Also available as individual disks for £3.00 each.

### PROGRAMMING LANGUAGES

**PD211** - NorthC 1.3 the C compiler that features compiler, linker, assembler, examples and tools. £3.00.

**FF456/457** - CManual V2.0 is a complete C manual for the Amiga includes 70 example programs on the disk with source code. £6.00.

**FF339** - PCO Pascal Compiler. £3.00.

**FF347** - Cursor the Amiga Basic Compiler. £3.00.

**PD60** - Modula II compiler. £3.00.

**FF314** - A68k V2.61 of the 68000 macro assembler. £3.00.

### CLIP ART

The following 4 ClipIt! packs are all Black and White clip art spot illustrations suitable for any program with graphic capabilities. Each pack contains 5 disks.

**CIA1** - Subjects covered: sports, flags, animals, cartoons, humorous, Xmas, Jewish, Borders, Halloween, Valentines, horses, eyes, alphabets, hands, 1930's trademarks, zodiac, cars etc. plus lots more. £12.50.

**CIA2** - Subjects covered: men, women, illuminated A to Z, arrows, stars, explosions, humorous, cartoons, pointing hands, food and more. £12.50.

**CIA3** - Subjects covered: Fruit, herbs, meat, arrows, special occasions, vegetables, kitchen utensils, cups and glasses, art deco and breakfasts. £12.50.

**CIA4** - Subjects covered: More Art Deco, Babies, Boys and Girls, lots of humorous, illuminated A to Z, scrolls, more special occasions and calligraphic ornaments. £12.50.

### MUSIC

**PD281/282** - Oktalyzer V1.1 the music composer. £6.00.

**PD285** - Game Music Creator create music for games, demos etc. £3.00.

**PD299** - MED V3.00 the the music editor with MIDI support. £3.00.

**PD553** - Sound Tracker v4.00. £3.00.

### PROGRAMS

**PD499** - AmiBase V3.76 the excellent database. £3.00.

**FF425** - A-Gen V3.1 an excellent genealogy database program. Limited to 600 persons/300 marriages. Requires 1MB RAM. £3.00.

**FF434** - Typing Tutor, a simple typing tutor program which measures your typing speed and adjusts the level of difficulty accordingly. £3.00.

**AMP1** - Home Business Pack: UEdit the excellent wordprocessor and spell checker, Visicalc the spreadsheet, RIM and JBase two brilliant databases only £8.50!

**PD416** - NComm V1.9. ALL you need for communicating via the phone line. £3.00

**PD59** - Amateur Radio Disk: StarTerm V3.0, Packet Terminal programs, a HAM Database for the Amiga Amateur Radio Group, Morse Code, Satellite Tracking and loads of HAM utilities. £3.00.

**AMP4** - Starter Utility Pack: This pack was compiled with the new Amiga user in mind. All programs are icon driven and have any necessary documentation. The pack includes: file compressors used on the Amiga - ARC, LHARC, Zoo and Power Packer, DirWork the friendly environment that allows many of the CLI commands to be executed at the click of your mouse. Also a virus checker and destroyer, an icon editor, a sector editor, a communications program for modem users and lots more, PLUS the word processor UEdit and the Database JBase! This excellent pack is only £8.50!

**FF366** - PrintStudio V1.2 this program allows you to print any text file in many styles, print any part of or a whole picture, screen or window, also control your printer and much more. £3.00.

**TB16** - CLI Wizard V1.2 is the excellent mouse operated CLI replacement makes using the CLI a doddle! £3.00.

**PD279** - ESA Utility Disk 1. This disk contains 3 dozen excellent utilities! All menu driven it includes: Amiga Tool, BootGenerator, Coder Board, DCCopyII, Font Ripper, Menu Maker, Power Utility, Power Packer, PPMore V1.2, Save IFF, Scanner V2.0, Scroll Maker 2, plus virus checkers and destroyers and loads more! £3.00!

**FF378** - MACH II V3.0 this brilliant 'all in one' utility features your help screen, mouse accelerator, PopCLI, Screen Blanker, Mouse OFF, Sun Mouse ( activates a window by placing mouse it), Click To Front (bring window to front by clicking on it), Cycle (move a window or screen to back with left then right mouse button click, Window and Screen Shuffler, Clock, Alarm, Beeper and loads more. Excellent! £3.00!

**PD300** - The Master Virus Killer the latest version is always in stock. This utility recognises 124 virii! A full list is available, excellent and very easy to use and very comprehensive. £3.00!

**PD62** - The Public Dominator Anti Virus disk contains Virus X V4.01, VCheck V1.2 (for memory), VCheck V1.9 (for disk drives), Zero Virus V1.3 the fully integrated virus detector and killer. Also Boot Block Champion the utility and information on boot blocks. £3.00.

**TB31** - ShowWiz show any picture with or without your own controlling script, show 1 picture, or even 1 or more disk fulls, also play a music file and show in text in any colour! Perfect for presentations. £3.00.

**PD93** - ARP V1.3 the Amiga DOS Replacement Project. £3.00.

**FF228** - JazzBench v0.8 is a multitasking WorkBench replacement. £3.00.

**FF246** - NoClick V3.6 this program stops your disk drives clicking when there is no disk in the drive. £3.00.

**FF251** - DiskSalv V1.42 more powerful than Disk Doctor this utility will attempt to salvage data from bad disks. £3.00.

**PD304** - MessyDOS handles MSDOS formatted disks (this includes Atari ST) exactly the same way that native Amiga disks are used. £3.00.

**FF243** - PassWord V1.21 you specify the password for your system security. Also Pcopy V2.0 the excellent disk copier. £3.00.

**FF279** - MRBackup V3.3 the hard disk backup utility. £3.00.

**FF300** - TitleGen V1.6 excellent 'script language' that creates scrolling text in any font and colour upto 500 lines long! Perfect for video titles. £3.00.

**FF213** - ICONS! This disk contains 300 8 colour icons! £3.00.

**AM22** - Printer Driver Generator this program will create a driver for your printer. £3.00.

**APDC18** - Floppy Disk Utilities: QuickCopy, Disk Mapper, Disk Salvage, Virus Check, Directory Master, Amiga Monitor, Calculator and more. £3.00.



**CATALOGUES**  
A concise printed catalogue is supplied with each order. A disk based catalogue showing full details of all our products costs only £1.00 or is free if with any purchase of £10.00 or over!

**TO ORDER**  
Simply quote the order code given in RED.

**WE ARE**  
Public Dominator Amiga, PO Box 801, Bishops Stortford, Herts, CM23 3TZ, UK.  
Tel&Fax: 0279 757 692

All prices are fully inclusive no more to pay.  
Foreign orders must add £2.75 for registered post.

**PD0M SUPPLIES**

Blank disks including labels:  
10-£7.00, 50-£33.00.

Disk boxes: 10 capacity £1.00,  
40 cap. £6.50, 80 cap. £9.00.

Disks and box:  
10 £7.75, 50 £36.00 and 100 £67.00.

Blank disk labels:  
100-£3.00, 1000-£20.00.

Disk cleaning kits - £3.00.

Mouse mats - £4.00.



# GET DOWN TO BUSINESS

...or programming or video or DTP or comms or music or education or graphics or AmigaDOS or...

**Amiga Shopper** is the magazine dedicated to taking the Amiga seriously. Our panel of expert writers bring you the best tips and advice every month on everything from programming AMOS to getting the best results from a digitiser. Add to that comprehensive and up-to-the-minute reviews of the latest hardware and software and you're on to a winner.

**In this month's packed issue, out now:**

- **Sound samplers - How can you choose the best?**
- **Scanning - The best hand scanner revealed**
- **C programming - Using the mouse with your programs**
- **Canon's BubbleJet printer - Laser quality at dot-matrix price?**
- **Comms - The best Amiga bulletin boards examined**
- **Action Replay II - Could you use a freezer cartridge?**

**Plus 12 pages of solutions to Amiga problems in Amiga Answers**



**AMIGA SHOPPER - FOR PEOPLE WHO ARE SERIOUS ABOUT THE AMIGA**

Image processing just took a big step up. Once it meant converting files from HAM to 32-colour or adding corny special effects. Now, for the first time, you can cut 24-bit 'True Colour' images seamlessly together into a perfect photo-montage. **Brian Larkman** yells 'Gotcha!' as he airbrushes Maggie out of the Downing Street press photos...

# Art Department Professional

Image Processing Software ■ £199.95 ■ ASDG

**REALISM? DON'T TALK TO ME** about realism! It's a tricky task for a computer artist to get an image exactly right. Usually you choose the best picture you can find to digitise, or you create the most accurate model you can to render, or you paint to the best of your ability. But then the colour, contrast or size is not quite right, or you need a special effect, or... something! At this point you turn in desperation to an image processing programs.

Nowadays, to get the very best images possible from the Amiga you just have to hang the expense and work with 24-bit colour. Even if it's a HAM picture you're working on, you only get great results if all the processing is carried out using the greatest amount of information possible – the 16-million-colour palette of 24-bit 'True Colour'.

*Art Department Professional* will accept image data from almost any source, convert it to 24-bit, process it, mix it with any other image and save it in almost any common – or uncommon – image format, all in True Colour.

**CUTTING IT UP**  
The desert background and the figure were digitised separately using DigiView, which outputs an RGB file format that is very close to being 24-bit colour. I then cut the runner, pasted her in and colour-balanced the whole thing. Notice the dodgy edges around the runner: this is currently *Art Dept Pro's* main failing.



Keeping it flexible, *Art Dept Pro* uses separate Loader Modules so new ones can be added in as new image formats appear. All Amiga IFF formats as well as 3D rendering formats for *Sculpt*, *Turbo Silver* and *Imagine* are covered. TIFF, GIF and many others are available, making it possible to pinch stuff from Macs or PCs, so finding images is easy.

An increasing number of programs save 21-bit or 24-bit files as well as the normal IFF images. NewTek's top digitiser Digi-View, for instance, is a good source of almost True Colour material.

Though *Art Dept Pro* has no proper drawing tools, simple rectangular backgrounds with vertical, horizontal or diagonal colour gradations can be created and saved within the program, so you're not at a loss for something else to do with a great picture on top of an uninspiring background.

You're spoilt for choice when you've finished playing with your image too. Output is just as flexible as input, allowing *Art Dept Pro* to be used as a versatile file conversion system. As well as all the image formats used for the Loaders, you can also save Postscript files in either Encapsulated or Non-Encapsulated form, so high-quality print output is guaranteed.

Three control screens offer you a wide range of adjustable parameters so that you can output the stuff direct to a Postscript printer. Similarly, images can be sent direct to any graphics peripheral that has a Saver module. Both the Mimetics and ACS Harlequin frame-buffers are supported in this way. If all this is a little out of your league, *Art Dept Pro* will also

AMIGA FORMAT

124

SEPTEMBER 1991

**Art Department Professional**  
£199.95 Silica  
081 309 1111  
Available September

## THE CONTROL PANEL

### INPUT AND OUTPUT OPERATIONS

Loaders and Savers that can handle a heap of different file formats and Amiga screen modes make file conversions easy. It comes with most Amiga, Mac or PC formats including PostScript, but because the Loader/Saver system is modular, new ones can be added. *Backdrop* creates simple gradient backgrounds.

### COLOUR CONTROLS

Balance controls: Red, Green and Blue levels, Brightness, Contrast and Gamma correction.

Six Dither methods including Random ensure a good balance between speed and accuracy.

The Palette can be locked, Enhanced and Edited.

### IMAGE OPERATORS

The Image Processing Operators are modular allowing new functions to be added later. A reasonable range is offered including Negative, Flip, colour-to-grey and Dynamic range.



### COMMAND GADGETS

Load - Displays requester for raw data input according to Loader, Orientation, and whether you are compositing.

Save - Requester allows raw data to be saved in the Saver format or any screen rendered according to Screen Controls.

### SCREEN CONTROLS:

You can select screen resolution and number of colours for rendering 24-bit data when the Execute Gadget is pressed. Includes Hi-res HAM modes.



**DROP SHADOWS:** A mask of the runner, pasted at 50% mix produced the shadow, followed by the original.



**SOLARISATION:** The Range operator produces Solarising effects by compressing and re-expanding the dynamic range.



**EMBOSSING:** Easy embossing by pasting a negative image then the positive at 50% mix, offset by two pixels.

**"SO WHAT IS THIS 24-BIT COLOUR ANYWAY?"** you may well be wondering. Well, it's actually quite simple. Each bit is an on/off switch. Two-colour screens use one switch for each pixel on the screen - on or off, black or white. Four colours use two switches, eight colours use three, sixteen use four and so on, the number of colours doubling with each extra bit or on/off switch. 24 switches - or, to use the correct terminology, 24 bits per pixel - provides a palette of over 16 million colours for each pixel.

**WHY USE 24-BIT COLOUR?** Well, exciting as it was using HAM's 4096 colours while the Mac was still b&w and the PC had four colours, times have changed. Macs and PCs now have millions of colours - at a price - leaving the Amiga HAM-strung. Affordable 24-bit systems are appearing - like BlackBelt's £300 HAM-E - cheap 'true colour' for all. The difference? - 16 colour dithered top right, undithered top left; HAM dithered bottom right, undithered bottom left; 24-bit in the centre.

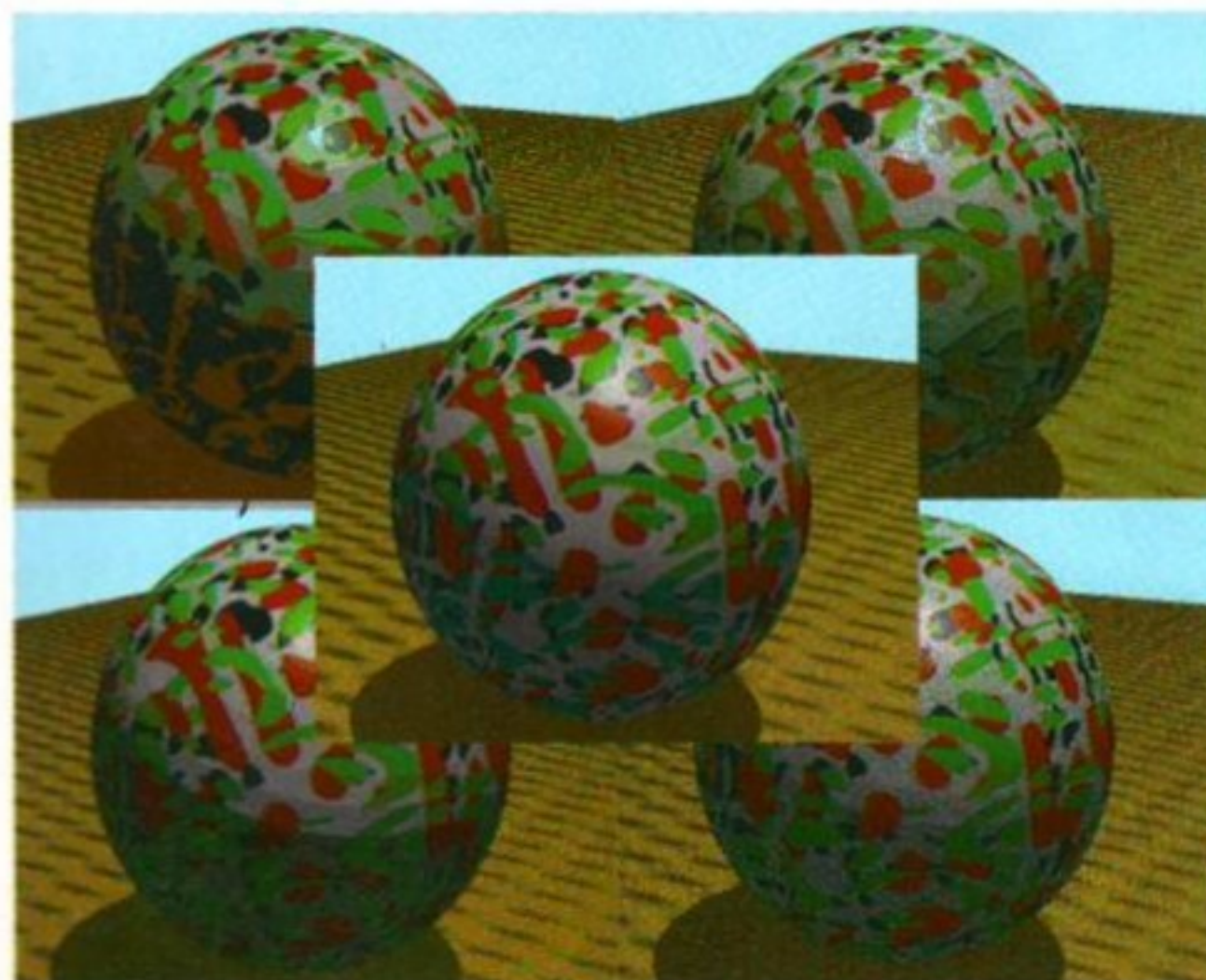

output yer ordinary HAM, EHB 16-colour or even four-colour images with better dithering than any other program, bar none.

"But what happens inbetween the input and output?" I hear you cry. Aha! We're coming to the crunch. What *Art Dept Pro* is really all about is not only file conversion, but also image processing and digital photo-montage. Let's look at the image processing first.

Any picture file you load in is converted into raw 24-bit data. This uses up huge amounts of memory, so at least 4Mb is recommended, making this a real top-end prospect. Now the program can apply any or all of a number of functions, repeatedly if necessary.

The overall colour balance - red, green or blue level, brightness, contrast and even gamma correction - can be altered with simple sliders. The image can be rotated, flipped and resized, cropped, turned made negative or monochrome, and converted to line art. Video colour 'smear' can be reduced by 'modifying the dynamic range', or in plain English cutting the number of colours slightly to get rid of the intrusive ones. The possibilities are endless.

Now for the clever bit. Once the various components of your montage have been processed individually, you can start sticking them into

**MASKING, MODELLING AND A BACKGROUND** More elaborate masking plus the Background Loader make the window transparent for the sun (modelled in *Sculpt4D* and rendered in *Real3D*) to shine through. The ghost-like runner is pasted at 40% mix so she seems almost see-through. Lining things up without seeing them was quite difficult, needing several attempts.

**PASTING COLOUR INTO GREY IMAGES** The room was converted to an 8-bit greyscale and then back to 24-bit so that the coloured objects could be pasted in where I wanted them.



place, a task known to the experts and within the program as 'compositing'. Areas you want to be blank or transparent must be masked using a paint program first. Even allowing for masking, compositing is fairly straightforward, as long as you keep a careful track in your mind of the 'layering' of the montage: in other words, which picture is on top of which.

If you've got the COMPositing button pressed, when you select an image to load the program passes you straight to the compositing screen to decide how and where it will be loaded. Positioning is a rather hit-and-miss affair, however, with only an outline box of each object for guidance.

Time for some constructive criticism, here. The next upgrade of *Art Dept Pro* really needs some simple drawing tools and a more friendly interface for compositing. Even just a grey-scale or 16-colour on-screen representation of the 24-bit picture would be much better than this blank rectangle.

But you're not left completely in the dark. At any time during image processing or during compositing, you can view the picture so far in any of the normal (and some abnormal) Amiga modes. The dithering methods used are so good that even a 16-colour hi-res version gives a pretty darned good impression of what the final 24-bit picture will look like. Work in progress can also be saved in 24-bit or Amiga mode as you go along.

So, does it cut the mustard? Well, the competition to *Art Department Professional* is pretty limited, provided you don't start making comparisons with Mac software. The classic Amiga image processing programs, *Pixmate* and *Butcher*, are too old for 24-bit, but there's a lot of new stuff on the way and True Colour image processing is bound to be one of the big growth areas on the Amiga.

For now, *Art Department Professional* has three distinct advantages. One, it's the first of its kind, so there's nothing else you can get to do this job. Two, it really does give excellent results - with the one exception of the edges around images. And three, its modular form will let it keep on improving. *Art Department Professional* is the best there is and is well set up to stay that way.

### Art Department Pro

#### SPEED

Reasonable - but an accelerator and lots of memory are essential for professional work.

#### DOCUMENTATION

A solid ring-binder with plenty of reference but not much tutorial help.

#### ACCESSIBILITY

Simple control panels with good labelling. Compositing is a stab in the dark though.

#### FEATURES

Good, with many unique aspects. Easy to add updates. Only major fault is edging.

#### VALUE

Simple yet powerful with no real competition - for now, that is.

AMIGA  
Verdict  
FORMAT

75%

THE WORLD'S MOST POWERFUL FREEZER-UTILITY CARTRIDGE

IS NOW EVEN BETTER

# AMIGA ACTION REPLAY

## MK II IS HERE!!

STILL ONLY  
**£59.99**  
FOR THE A500/1000

A2000 VERSION  
AVAILABLE

**£69.99**

PLEASE STATE WHICH COMPUTER  
YOU HAVE WHEN ORDERING

AMIGA ACTION REPLAY SIMPLY PLUGS INTO THE EXPANSION PORT OF YOUR AMIGA AND GIVES YOU THE POWER TO FREEZE MOST ANY PROGRAM, THEN YOU CAN.....

### JUST LOOK AT THE UNMATCHED RANGE OF FEATURES

● **SAVE THE ENTIRE PROGRAM IN MEMORY TO DISK**

Special compacting techniques enable up to 3 programs to fit on one disk. Now saves directly to disk as Amiga Dos - reloads independently of the cartridge - even transfer to hard drive! Works with up to 2 Megs of Ram - even 1 Meg Chip Mem (Fatter Agnus).

● **UNIQUE INFINITE LIFE/TRAINER MODE - NOW MORE POWERFUL**

Allows you to generate more and even infinite lives, fuel, ammo, etc. Perfect as a trainer mode to get you past that "impossible" level. Very easy to use.

● **IMPROVED SPRITE EDITOR**

The full Sprite Editor allows you to view/modify the whole sprite set including any "attached" sprites. RANGE OF IMPROVED FEATURES.

● **VIRUS DETECTION**

Comprehensive virus detection and removal features to protect your software investment. Works with all presently known viruses.

● **SAVE PICTURES AND MUSIC TO DISK**

Pictures and sound samples can be saved to disk. Files are saved directly IFF format suitable for use with all the major graphic and music packages. Samples are displayed as screen waveform.

● **SLOW MOTION MODE**

Now you can slow down the action to your own pace. Easily adjustable from full speed to 20% speed. Ideal to help you through the tricky parts!

● **RESTART THE PROGRAM**

Simply press a key and the program will continue where you left off.

● **FULL STATUS REPORTING**

At the press of a key now you can view the Machine Status, including Fast Ram, Chip Ram, RamDisk, Drive Status, etc.

● **POWERFUL PICTURE EDITOR**

Now you can manipulate and search for screens throughout memory. Over 50 commands to edit the picture plus unique on screen status "overlay" shows all

the information you could ever need to work on screens. No other product comes close to offering such dynamic screen handling of frozen programs!!

● **MUSIC SOUND TRACKER**

With Sound Tracker you can find the complete music in programs, demos, etc. and save them to disk. Saves in format suitable for most track player programs. Works with loads of programs!!

● **AUTOFIRE MANAGER**

From the Action Replay II preference screen you can now set up autofire from 0 to 100%. Just imagine continuous fire power? Joystick 1 and 2 are set separately for that extra advantage!

● **DISKCODER**

With the new "Diskcoder" option you can now 'tag' your disks with a unique code that will prevent the disk from being loaded by anyone else. "Tagged" disks will only reload when you enter the code. Very useful for security.

● **PREFERENCES**

Action Replay II now has screen colour preferences with menu setup. Customise your screens to suit your taste. Very simple to use.

● **DISK MONITOR**

Invaluable disk monitor - displays disk information in easy to understand format. Full modify/save options.

● **DOS COMMANDS**

Now you have a selection of DOS commands available at all times - DIR, FORMAT, COPY, DEVICE, etc.

● **DISK COPY**

Disk Copy at the press of a button - faster than Dos Copy. No need to load Workbench - available at all times.

● **BOOT SELECTOR**

Either DF0 or DF1 can be selected as the boot drive when working with Amiga Dos disks. Very useful to be able to boot from your external drive.

### PLUS A MACHINE CODE FREEZER MONITOR WITH EVEN MORE POWER!!

EVEN MORE FEATURES INCLUDING 80 COLUMN DISPLAY AND 3 WAY SCROLLING:

- Full M68000 Assembler/Disassembler
- Full screen editor
- Load/Save block
- Write String to memory
- Jump to specific address
- Show Ram as text
- Show frozen picture
- Play resident sample
- Show and edit all CPU registers and flag
- Calculator
- Help command
- Full search feature
- Unique Custom Chip Editor allows you to see and modify all chip registers - even write only registers
- Notepad
- Disk handling - show actual track, Disk Sync, pattern etc.
- Dynamic Breakpoint handling
- Show memory as HEX, ASCII, Assembler, Decimal
- Copper Assemble/Disassemble - now with suffix names

REMEMBER AT ALL TIMES YOU ARE INTERROGATING THE PROGRAM IN IT'S "FROZEN" STATE WITH ALL MEMORY AND REGISTERS INTACT - INVALUABLE FOR THE DE-BUGGER OR JUST THE INQUISITIVE!

**WARNING 1988 COPYRIGHT ACT WARNING**

Date Electronics Ltd., neither condones nor authorises the use of its products for the reproduction of copyright material.

The backup facilities of this product are designed to reproduce only software such as Public Domain material, the users own programs or software where permission to make backups has been clearly given. It is illegal to make copies, even for your own use, of copyright material, without the express permission of the copyright owner, or the licensee thereof.

HOW TO GET YOUR ORDER FAST!

TELEPHONE [24Hrs] **0782 744707** CREDIT CARD ORDERS

ORDERS NORMALLY DISPATCHED WITHIN 48 Hrs. ALL CHEQUES/POSTAL ORDERS MADE PAYABLE TO....



**DATEL ELECTRONICS LTD.**

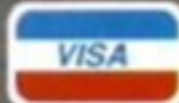

GOVAN ROAD, FENTON INDUSTRIAL ESTATE, FENTON, STOKE-ON-TRENT, ST4 2RS, ENGLAND.

FAX 0782 744292 TECHNICAL/CUSTOMER SERVICE 0782 744324



L i m i t e d

# AMIGA PRO SAMPLER STUDIO II + DATEL JAMMER

- New design hardware now plugs into expansion socket of A500 completely freeing the parallel port.
- Save files in Raw or single, multi-octave IFF format.
- Surface mount technology, twin A/D converters for realtime stereo sampling.
- Extensive filters for extremely clean and noise-free sampling.
- Through bus allows existing add ons, e.g. hard drive.
- The NEW Sampler II software has been completely re-written in 100% Machine Code and incorporates faster routines, bigger displays and many new editing features such as Cut, Copy, Insert, Replace, Mix, Erase, etc.
- Stereo lock control.
- Separate zoom windows and controls for left and right channels.
- Multi-bank facilities for 1 Meg users.
- Adjustable trig record level and sound monitor.
- Separate buffer for editing waveforms and improved wave-editor with instant update.
- Envelope control panel for ramping up and down re-scale amplitude, noise filter and scan waveform.
- On screen display of filenames sample rate, length, etc.
- Inputs for microphone or line 1/4" jack and DIN connections at rear of unit.

**NOW ONLY £69.99** COMPLETE (A500)  
INTERNAL 2000/1500 VERSION ALSO AVAILABLE

**STEREO  
SAMPLING**

**CUMANA**  
QUALITY DISK DRIVES

## CUMANA CAX 354 3.5" DISK DRIVE

- Legendary Cumana quality now at an extremely low price!
- Throughport allows daisy-chaining with other disk drives.
- A full 1 meg of unformatted capacity (880K fully formatted).
- A good length of cable is provided for convenient positioning on your desk etc.
- High precision head positioning.
- On/Off switch.
- Extremely quiet and click free operation.

**NEW LOW PRICE  
ONLY £69.99**

IF NEXT DAY COURIER DELIVERY IS  
REQUIRED THEN PLEASE ADD £5

## NEW MINI SAMPLER



- A top quality 8 bit mono sampler complete with Pro Sampler and Jammer software.
- Also compatible with most other PD Sampler software.
- Inputs for microphone or line 3.5mm jack and din connections.
- Utilises latest surface mount technology and incorporates all the features found on bigger, more expensive samplers.
- Easy to use - just plug in and start sampling!

**ONLY £24.99**

COMPLETE PLEASE STATE  
A500/1000/2000/1500

## LC 200 COLOUR PRINTER

**NOW YOU CAN PRINT  
OUT YOUR PICTURES  
IN FULL COLOUR!**

- The Star LC200 Colour Printer not only prints in Near Letter Quality for your regular jobs but also prints out your pictures in genuine colour!
- No more to buy - just plug in and print!!
- Comes complete with printer lead.



**NOW ONLY £229.00**

## MICROMIDI

- Fully compatible Midi Interface for A500/2000.
- MIDI In - MIDI Out - MIDI Thru.
- Fully Opto isolated.

**NOW ONLY £19.99**

## MIDIMASTER

- Midi In - 3 x Midi Out & Midi Thru.
- Full Midi Interface for A500/1000/2000 (please state which model req.).
- Compatible with all leading Midi packages (In D/Music).
- Fully Opto isolated.

**NEW  
LOWER  
PRICE**

**NOW ONLY £29.99  
INC. 2 FREE MIDI CABLES**

## INTERNAL MIDI INTERFACE

FOR 2000,1500

- Now an internal interface for the Amiga 2000 and 1500.
- Easily fitted in minutes.
- Leaves serial port free for other uses.
- Midi In, 3 x Midi Out and Midi Thru.
- Fully compatible - Opto isolated.

**ONLY £29.99  
INC. 2 FREE MIDI CABLES**

## GENIUS MOUSE

- High quality direct replacement for mouse on all Amigas.
- Teflon glides for smoother movement.
- Rubber coated ball for minimum slip.
- Optical system counting - 500/mm.



**NEW  
LOWER  
PRICE**

Special offer - FREE Mouse Mat + Mouse House (worth £7.99)  
**NOW ONLY £24.99**  
COMPLETE

**HOW TO GET YOUR ORDER FAST!**

TELEPHONE [24Hrs] **0782 744707** CREDIT CARD ORDERS  
ORDERS NORMALLY DISPATCHED WITHIN 48 Hrs. ALL CHEQUES/POSTAL ORDERS MADE PAYABLE TO...

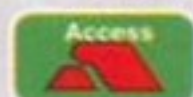

**DATEL ELECTRONICS LTD.**



GOVAN ROAD, FENTON INDUSTRIAL ESTATE, FENTON, STOKE-ON-TRENT, ST4 2RS, ENGLAND.  
FAX 0782 744292 TECHNICAL/CUSTOMER SERVICE 0782 744324

**DATEL**  
Electronics

# VIDEO DIGITIZER II



**ONLY**  
**£89.99**

## NOW YOU CAN DIGITIZE PICTURES FROM ANY VIDEO CAMERA OR VCR

- Completely newly designed interface that plugs into the expansion connector of the Amiga 500 or internal connector of the Amiga 2000.
- Standard phono video input 0.5 to 2.0 volts to take signals from TV, video or camera.
- Control brightness, contrast and throughport on A500 version.
- Frame grab in 1/50 second, record update up to 3 frames per second.
- Single or continuous update in 4, 8 or 16 grey levels.
- Play frames backwards or forwards up to 15 frames per second.
- Save Raw, IFF or sequence files.
- Automatically adjust for maximum number of frames according to memory available.

- Display 256 x 256 pixels, but optional 320 x 256 IFF Save. Screen editing features Cut, Copy, Brush, Paste and Undo. Effects menu to reverse pos/neg, compress, etc.
- Second display editor controls sequence production: Record, Play, Insert, Clear, Delete Frames.
- Set start and end position number of frames saved, number frames, step backwards and forwards, loop, etc. Time lapse feature adjustable in 1 second increments to 1 hour between each frame. Ideal for capturing flowers opening, sky movements, special effects, etc.
- Separate player programs included to insert into your own program disks. Hard disk transfer program.
- Please state A500 or 2000 version when ordering.



## NOW WITH FULL COLOUR — OPTION —

**WITH THE ADDITION OF THE RGB SPLITTER, TO THE VIDEO DIGITISER II YOU CAN OBTAIN COLOUR IMAGES IN ONLY 1 SECOND!!**

- The Splitter unit plugs alongside the Digitiser and a lead is supplied to couple the two units together.
- Full adjustment of Red, Green and Blue signals together with a saturation control enabling you to take full control over any image.
- The Splitter is switched in software and comes complete with Digitiser Colour Software.
- You can select single continuous colour or B/W input. Files can be saved in Raw 4096 colour format, 8 or 32 colour IFF files or 16 shade B/W IFF.
- Features include full palette control editing of frame and colour retouch calculator.
- Input from camera, camcorder or video recorder (paused). No more messing with colour filters.

RGB COLOUR SPLITTER  
**ONLY £79.99**

BUY VIDEO DIGITISER II PLUS  
RGB COLOUR SPLITTER FOR  
**ONLY £149.99**

**HOW TO GET YOUR ORDER FAST!**

TELEPHONE [24Hrs] **0782 744707** CREDIT CARD ORDERS  
ORDERS NORMALLY DISPATCHED WITHIN 48 Hrs. ALL CHEQUES/POSTAL ORDERS MADE PAYABLE TO....

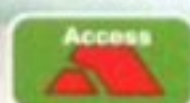

**DATEL ELECTRONICS LTD.**



GOVAN ROAD, FENTON INDUSTRIAL ESTATE, FENTON, STOKE-ON-TRENT, ST4 2RS, ENGLAND.  
FAX 0782 744292 TECHNICAL/CUSTOMER SERVICE 0782 744324

**DATEL**  
Electronics



# MORE MEMORY POWER!

**NOW YOU CAN ADD UP TO 1.5 MEGS TO YOUR AMIGA AT THE LOWEST PRICES EVER!!**

**UNIQUE FASTMEM/  
CHIPMEM OPTION\***



## PRO-RAM PLUS™

- THE FIRST RAM UPGRADE CARD TO OFFER THE UNIQUE FASTMEM OR CHIPMEM OPTION AT THE FLICK OF A SWITCH\*. NOW YOU CAN HAVE THE EXTRA SCREEN HANDLING ABILITY OF THE A2000 - PLUS LOTS MORE!!
- Simply plug into your Amiga A500 and upgrade to a full 1 Meg in minutes!!
- Features the latest 1 Meg DRams. Low chip count means very low power consumption. No bigger than a Credit Card!!
- Top quality high grade PCB and connector to give unmatched reliability - 12 months guarantee.
- Switch to enable/disable plus "ChipMem" option\*.
- Now you can run ALL Amiga 1Meg programs.
- Also available with clock/calendar option.
- Easily fitted into the slot under any A500 - does not affect warranty.

**NOW ONLY £24.99** STAND/NO VERSION  
**£34.99** FOR CLOCK VERSION

### \*CHIPMEM OR FASTMEM OPTION

### 2 MEG DEMO DISK WITH EACH RAM-MASTER II

- Yes, if your Amiga was bought in the last 12 months and has KICKSTART 1.3 then it probably has the 'fatter' 1 Meg AGNUS Chip. Even though this was not publicised by Commodore, those machines with the '02' AGNUS, have 1 Meg Chip Ram ability. The PRORAM PLUS™ board can be configured to give 512K of extra Chip Memory OR Fast Memory at the flick of a switch.
- With 1 Meg of Chip Memory you can do lots of things previously only available on the A2000 - more HiRes screens, multitasking graphics programs, CAD, DTP, larger sound samples, etc., etc.
- Remember, no other cards offer this unique feature.
- One simple soldering job is required to enable the "ChipMem" feature.
- Opening your A500 may invalidate your warranty.

**EVEN IF YOU DON'T HAVE THE LATEST AGNUS CHIP THE PRORAM PLUS™ WILL STILL GIVE YOU THE FASTRAM OPTIONS OFFERED BY OTHER BOARDS AND AT AN UNBEATABLE PRICE - YOU JUST CAN'T BEAT THESE DEALS!!**



**FREE!**

## RAM-MASTER II™

- IF YOU NEED EVEN MORE POWER THEN THE RAM-MASTER II™ IS FOR YOU!!
- Adds an extra 1.5 Megs to your A500 (giving a total free memory of 2 Megs).
- Uses the latest 1 Meg DRams resulting in extra low power consumption.
- Ram-Master II needs Kickstart 1.3 onwards.
- Complete with onboard clock/calendar.
- Top quality connections used throughout.
- Comes with 12 months guarantee.
- Easily fitted into the slot under your A500 - requires no soldering (the cover of your A500 must be removed for fitting "plug in" connector #)

**NOW ONLY £99.99** WITH 1.5 MEGS OF RAM  
**ONLY £39.99** FOR CARD WITHOUT RAM



**UPGRADE YOUR  
A500 TO 2 MEGS!**

### HOW TO GET YOUR ORDER FAST!

TELEPHONE [24Hrs] **0782 744707** CREDIT CARD ORDERS  
ORDERS NORMALLY DISPATCHED WITHIN 48 Hrs. ALL CHEQUES/POSTAL ORDERS MADE PAYABLE TO...

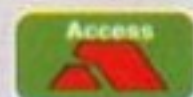

**DATEL ELECTRONICS LTD.**



GOVAN ROAD, FENTON INDUSTRIAL ESTATE, FENTON, STOKE-ON-TRENT, ST4 2RS, ENGLAND.  
FAX 0782 744292 TECHNICAL/CUSTOMER SERVICE 0782 744324



# DATEL

**A Top Quality 400 DPI  
Handy Scanner  
for the Amiga  
at a truly  
Unbeatable  
Price!!**



**NEW  
VERSION III  
SOFTWARE**

**NOW ONLY  
£129.99**

**COMPLETE  
HARDWARE/SOFTWARE**



## SCANNING COULDN'T BE SIMPLER...

**NEW FEATURES...** IFF Buffer Save 1600 x 1024 pixels, dual buffer and scan matching for 1 Meg users, view Buffer and NEW interlace version of software. Full keyboard control of most functions. Includes hard disk transfer to run under Workbench.

- Unmatched range of edit/capture facilities and keyboard control simply not offered by other scanners at this unbeatable price.
- An easy to handle Handy Scanner featuring 105 mm scanning width and 400 dpi resolution enables you to scan graphics and text into your Amiga.

- Adjustable switches for brightness/contrast levels.
- Powerful partner for DTP that allows for cut and paste editing of images etc.
- GeniScan gives you the ability to easily scan images, text and graphics and even offers 200Dpi Dual Scan Mode.
- Save images in suitable format for most leading packages including PHOTON PAINT, DELUXE PAINT, etc.
- Package includes GS4500 scanner, Interface, Power Pack and Scan Edit III software.

**GeniScan™  
GS 4500**

**COMES WITH  
FREE  
PHOTON PAINT**

- Comes complete with Photon Paint Illustrator Software.
- Huge range of features.
- Top selling graphics package.

## GOLDEN IMAGE OPTICAL REPLACEMENT MOUSE

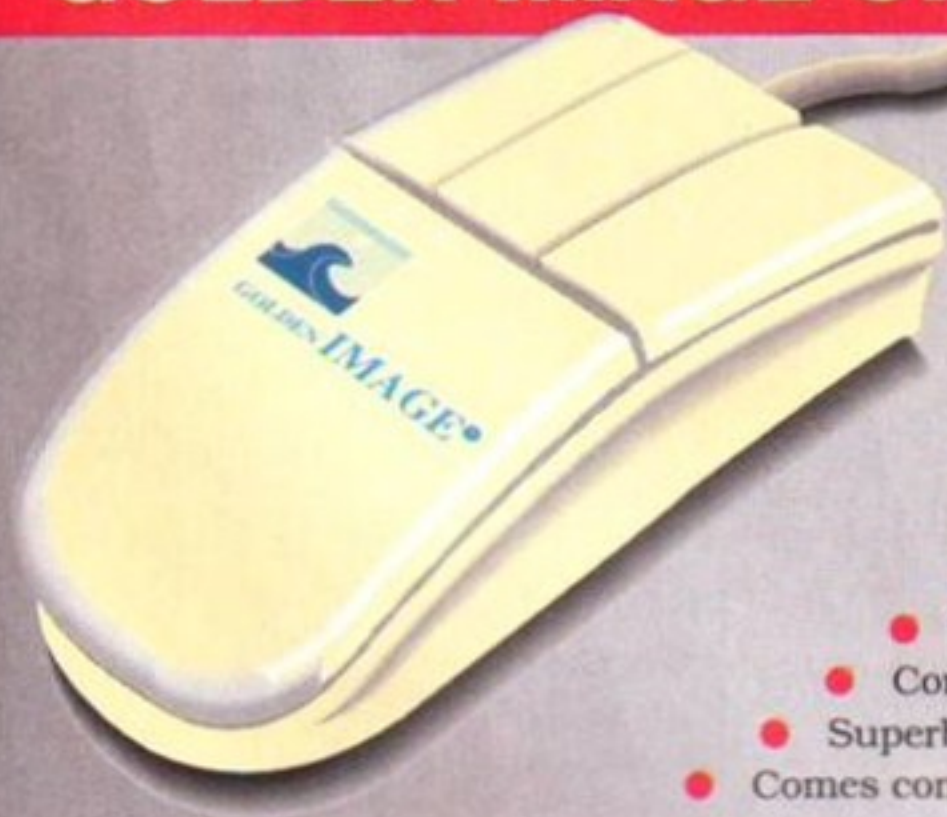

**... NOW A TRUE OPTICAL  
MOUSE! FOR THE AMIGA**

- **YES A FULL FEATURE OPTICAL MOUSE FOR YOUR AMIGA - THAT MEANS NO MOVING PARTS!**
- Incorporating full optical tracking and counting - no ball so no problems with clogging, slipping, etc.
- High count output for very fine movement.
- Two button microswitch action.
- Direct replacement for all Amigas.
- Comes complete with special "Optical Pad".
- Superbly styled - supersmooth shape moulded to fit the hand.
- Comes complete with moulded 9 pin connector.



**No more to buy!!**

**COMPLETE  
ONLY £39.99**

**HOW TO GET YOUR ORDER FAST!**

TELEPHONE [24Hrs] **0782 744707** CREDIT CARD ORDERS

ORDERS NORMALLY DISPATCHED WITHIN 48 Hrs. ALL CHEQUES/POSTAL ORDERS MADE PAYABLE TO...



**DATEL ELECTRONICS LTD.**



GOVAN ROAD, FENTON INDUSTRIAL ESTATE, FENTON, STOKE-ON-TRENT, ST4 2RS, ENGLAND.

FAX 0782 744292 TECHNICAL/CUSTOMER SERVICE 0782 744324

A/F SCAN

**DATEL**  
Electronics

L I M I T E D

# GENIUS DIGITIZING TABLET

## £129.<sup>99</sup>

COMPLETE FOR THE

# AMIGA

## ADD A PROFESSIONAL TOUCH TO YOUR DRAWING / CAD WORK



■ With the Amiga Genitizer graphics tablet you can streamline the operation of most graphic or CAD programs.

■ The Genitizer graphics tablet utilises latest technology to offer up to 1000 dpi resolution at the tip of a stylus

■ Complete 9" x 6" digitizing area plus

super accurate stylus combine to enable fast, accurate and easy control

■ Works by "mouse emulation"

so the Genitizer will work with most packages where mouse input is the usual method - Deluxe Paint, Photon Paint, CAD Packages etc. etc.

■ Supplied with template for Deluxe Paint.

■ Full easy to follow instructions.

■ This is the input method used on professional systems - now you can add a new dimension to graphics/CAD.

■ Fast input of drawing by "tracing" is made easy - plus "absolute reference" means you can move around the screen many times faster than by a mouse.

■ The Genitizer fits in the serial port of your Amiga 500/1000/2000 and "co-exists" with mouse.

■ Unlike a mouse the Tablet gives absolute co-ordinates so that tracking and menu selections are possible from the tablet face.

■ A pressure sensitive switch built into the stylus tip

activates the Tablet overriding the normal mouse input. When you are not using the Tablet you have normal mouse control

■ Complete system - Graphics Digitizer Tablet, Stylus, Deluxe Paint Template, Power

Adaptor, Test Software, Interface Unit plus Driver program - no more to buy!

### HOW TO GET YOUR ORDER FAST!

TELEPHONE [24Hrs] **0782 744707** CREDIT CARD ORDERS

ORDERS NORMALLY DISPATCHED WITHIN 48 Hrs. ALL CHEQUES/POSTAL ORDERS MADE PAYABLE TO....

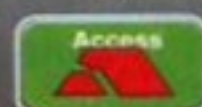

## DATEL ELECTRONICS LTD.



GOVAN ROAD, FENTON INDUSTRIAL ESTATE, FENTON, STOKE-ON-TRENT, ST4 2RS, ENGLAND.

FAX 0782 744292 TECHNICAL/CUSTOMER SERVICE 0782 744324

**DATEL**  
Electronics

L i m i t e d

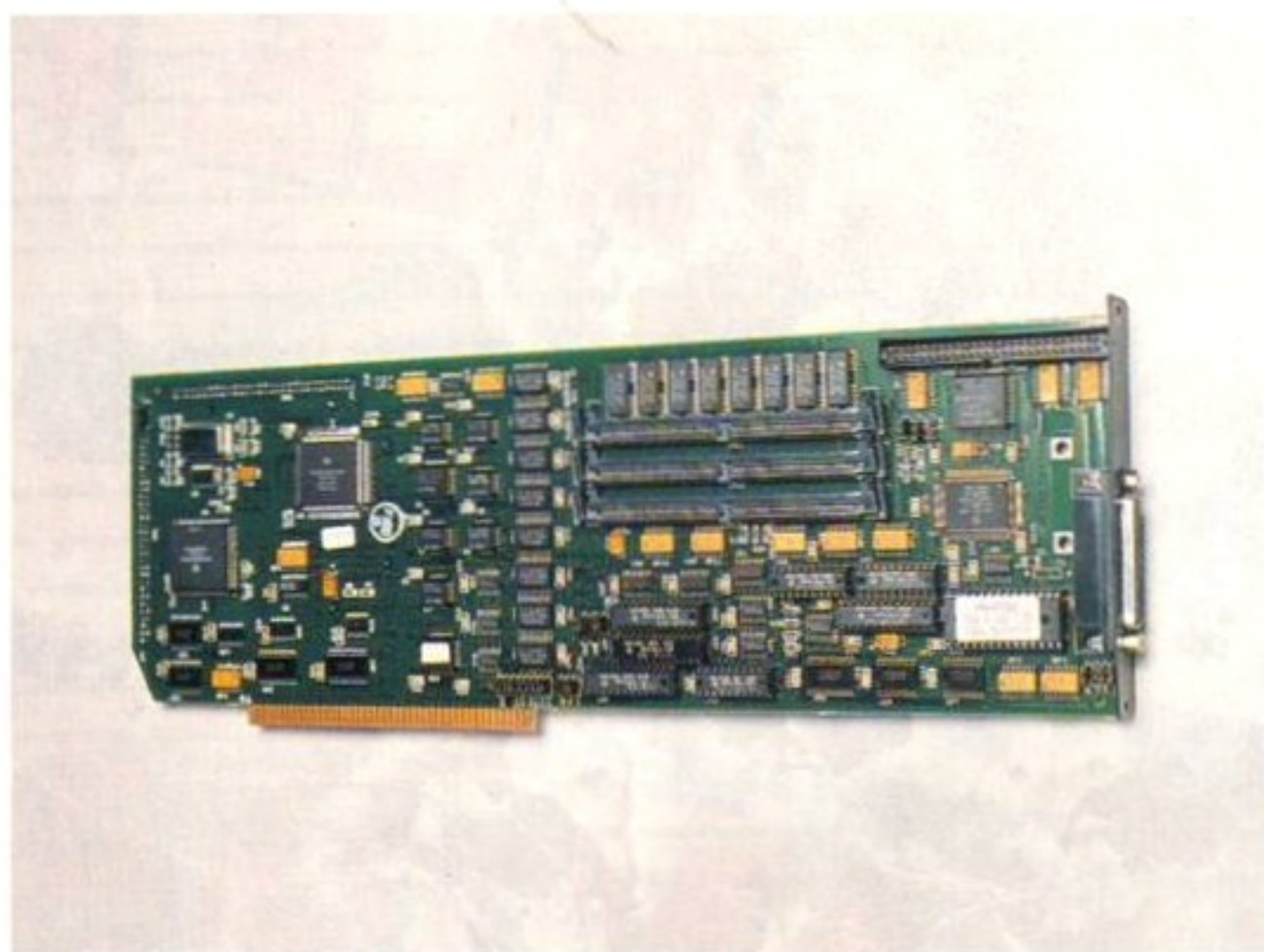

If you are seriously into graphics on your Amiga, you must have thought about buying an accelerator card. So check this out: a 68030 with bags of extra RAM and a SCSI controller that has the reputation of being the fastest on the market. **Brian Larkman** presses the loud pedal...

The Combo card contains a 33Mhz 68030 CPU and 68882 FPU (floating point unit), both surface mounted to a six-layer PCB. There is 4Mb of 60ns 32-bit RAM surface mounted, and slots for another 12Mb of SIMM chips. The SCSI controller is a very fast autobooting DMA device that can access 16Mb of RAM rather than the mere 8Mb that your Amiga is normally limited to.

**Does it work with everything?** Well, to be honest, no. But then my B2000 has a very early revision 4.4 board that has severe timing problems and suffers for it. Considering this, the GVP board is remarkable. Admittedly some programs seem a little fragile, falling over occasionally after quitting, but all Amiga owners are used to a little meditation. Those lucky people with revision 6 motherboard should have fewer problems.

The only other hitch is one that occurs with every accelerator I've ever tried. One in three start-ups or resets leaves you with the bottom fifth of the screen being out of bounds to the pointer. Sometimes another reset clears things, but usually a start from scratch is required.

Some software, particularly games, will refuse to work with a new processor, so most accelerators can also pretend to be the plain old 68000. In this case, you run a program called *Boot68000* - and if you do, it'll happily run everything.

More remarkably, if you don't run another program called *SetCPU* (which copies the KickStart into RAM for extra speed) the GVP combo will work with AMAX 2, speeding up the Mac emulator and making seriously good Mac programs like *Aldus FreeHand* worth using, for the first time!

**GVP, in their usual efficient way,** have created a very stable and powerful card. It all works excellently and, though I didn't make benchmark tests, it certainly makes the Amiga a lot faster, cutting a rendering task that would have taken half an hour down to about three minutes on average. Now everything in the next render can be made of glass and I'll have time for tea again... 

# Impact II Combo Board

68030 card with SCSI Controller and RAM ■ £1495 ■ Great Valley Products

**MOTORBIKES ARE SPEED** for pure fun: faster processors aren't. You have to have a darned good reason for investing this kind of money. Most things you can do with an Amiga aren't speeded up by a faster processor anyway, and you'll soon get sick of watching the Workbench window whizz smoothly up and down at the end of your mouse pointer only to discover that it's disk access times that are really slowing your word processing down.

But if you are into 3D rendering or getting obsessed by 24-bit graphics on the Amiga, speed is of the essence. Here a job that could take hours can be done in minutes instead, as the 68030 chip and its accompanying 68882

**Impact Series II Combo Board**  
£1495 Power  
0234 843388

**Impact Series II A500-HD+**  
£450 for 50Mb Power  
0234 843388

**Each 1Mb of RAM you add will cost £40 for the chips.**

maths co-processor bang through the complex mathematical calculations at many times the speed of a standard Amiga.

Over the past year I have slung plenty of different accelerator cards into the trusty 2000. When they didn't crash they all definitely speeded up the machine, but the differences between them were really minimal.

The GVP Combo is a different kettle of fish. It's claimed to be the fastest accelerator card around, and it certainly piles on the speed. The Workbench windows slide about silkily, *Imagine's* modelling views update almost instantly and you get through much less tea when you're waiting for a 3D render.

**GVP HAVE A REPUTATION:** their products are generally excellent. It isn't just the physical hardware, either: the software is nearly always very user friendly and doesn't crash.

The most popular GVP product of them all is the Series II Impact hard drive. Available for both the A500 and A2000, it features extremely fast controller circuitry, quality hard disk units (usually Fujitsu or the ultra-reliable Quantum) and lots of RAM expansion potential using SIMM modules.

The latest A500 version has its own power supply (no more unexpected crashes due to power shortage!) and a game/autoboot switch, which is dead useful - you can cut the hard drive out and boot from floppies while still using the RAM in the hard drive. If you're looking for an A500 hard drive, look no further.



This excellent hard drive is styled to look like an A500 expansion. The fact that it also works the best is pure coincidence!

## Impact II Combo Board

### SPEED ●●●●

GVP make the best accelerators and this is one of them. Definitely faster than most.

### DOCUMENTATION ●●●●

A 54-page booklet with plenty of reference and all you need to know to set up the board.

### ACCESSIBILITY ●●●●

Plug it into your CPU slot, modify your startup-sequence and go. Easy!

### FEATURES ●●●●●

Has everything that a 'state-of-the-art' board should have - and more.

### VALUE ●●●

The most expensive 33Mhz accelerator there is, but also the fastest. Adding memory with 4Mb SIMMs might be costly!



# 25%

# ★ MEDIA DIRECT

## AMIGA MEGA PACKS

### PACK 1 (1MB PACK)- CARTOON CLASSICS + MUCH MORE

- 512K MEMORY
- BUILT IN DISK DRIVE
- 4096 COLOUR GRAPHICS
- 4 CHANNEL STEREO SOUND
- KICKSTART 1.3
- WORKBENCH 1.3
- EXTRAS 1.3 AND TUTORIAL DISK
- AMIGA MOUSE
- TV MODULATOR
- POWER SUPPLY UNIT
- A500 KEYBOARD

- 512K RAM EXPANSION  
INCREASES MACHINE TO 1MB
- BART SIMPSON
- LEMMINGS
- CAPTAIN PLANET
- DELUXE PAINT III
- MOUSE MAT AND POCKET
- DUST COVER
- 10 BLANK DISKS AND BOX
- QUICKSHOT JOYSTICK

#### PLUS 10 MORE GAMES

- ☆ FOOTBALL MANAGER
- ☆ HOTSHOT
- ☆ LAS VEGAS
- ☆ FLIGHT PATH 737
- ☆ FIREBLASTER
- ☆ KARTING GRAND PRIX
- ☆ THAI BOXING
- ☆ SECONDS OUT
- ☆ MOUSE TRAP
- ☆ PLUTOS

ALL FOR ONLY **399.95**

**PACK 2**  
AS PACK 1 PLUS:-  
STAR LC200 COLOUR PRINTER  
**ONLY 604.95**

**PACK 3**  
AS PACK 1 PLUS:-  
STAR LC200 COLOUR PRINTER  
AND PHILLIPS CM8833/II  
STEREO COLOUR MONITOR  
**ONLY 828.95**

### CUMANA 3.5" EXTERNAL DRIVE



- ★ VERY QUIET
- ★ SLIMLINE DESIGN
- ★ THROUGHPORT CONNECTOR
- ★ ON/OFF SWITCH ON REAR
- ★ LONG CONNECTING CABLE
- ★ 880K FORMATTED CAPACITY
- ★ FITS ALL AMIGA'S



ONLY **59.95**

### ZYDEC EXTERNAL DRIVE

- ★ VERY QUIET
- ★ SLIMLINE DESIGN
- ★ QUALITY CITIZEN DRIVE MECHANISM
- ★ ON/OFF SWITCH ON REAR
- ★ LONG CONNECTING CABLE
- ★ 880K FORMATTED CAPACITY
- ★ FITS ALL AMIGA'S

ONLY **54.95**

### SWITCHES AND CABLES

AMIGA TO CBM 1084 MONITOR CABLE	9.95
AMIGA TO PHILLIPS CM8833/II MONITOR CABLE	9.95
AMIGA TO SCART MONITOR/TV CABLE	9.95
AMIGA TO HITACHI /GRANADA 7 PIN DIN	9.95
AMIGA TO MULTISYNC 15 PIN 3 ROW PLUG	9.95
AMIGA TO MULTISYNC 15 WAY 3 ROW SOC.	9.95
JOYSTICK/MOUSE EXTENSION CABLE	5.95
PARALLEL PRINTER CABLE	7.95
36 TO 36 WAY CENTRONICS CABLE	7.95
25 WAY D-TYPE MALE/MALE CABLE	7.95
25 WAY D-TYPE FEMALE/FEMALE CABLE	7.95
25 WAY D-TYPE MALE/FEMALE CABLE	7.95
2 WAY PARALLEL DATA SWITCH	12.95
2 WAY SERIAL DATA SWITCH	12.95
3 WAY PARALLEL DATA SWITCH	17.95
4 WAY PARALLEL DATA SWITCH	22.95

### NAKSHA UPGRADE MOUSE



- ★ SIMPLY THE BEST.
- ★ 280 DPI RESOLUTION
- ★ ERGONOMIC DESIGN
- ★ SMOOTH PRECISE OPERATION
- ★ 2 YEARS GUARANTEE
- ★ FREE MOUSE MAT
- ★ FREE MOUSE POCKET

**Naksha**

ONLY **22.95**

NOW INCLUDES :-  
**OPERATION STEALTH**



FROM U.S.GOLD REC. RETAIL PRICE 24.99

#### 5.25" DSDD DISKS

30.....	9.95
50.....	13.95
100.....	24.95
200.....	46.95

(ALL DISKS 100% ERROR FREE  
INCLUDES ENV./LABELS)

#### 5.25" DSHD DISKS

30.....	18.95
50.....	21.95
100.....	36.95
200.....	68.95

(ALL DISKS 100% ERROR FREE  
INCLUDES ENV./LABELS)

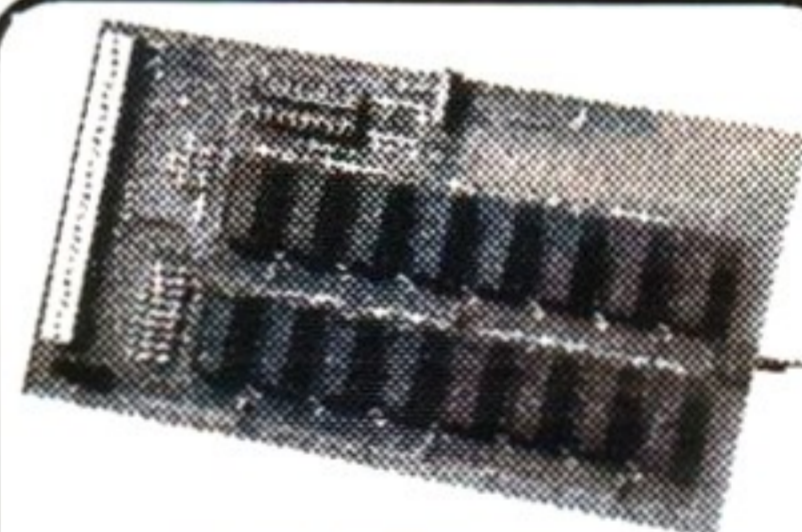

#### AMIGA 0.5 MEG UPGRADE

- ★ INCREASES MEMORY TO 1 MEGABYTE
- ★ 16 BIT TECHNOLOGY
- ★ REPLACEMENT FOR A501 EXPANSION
- ★ FIT IN MINUTES
- ★ ON/OFF SWITCH

ONLY **26.95** CLOCK VERSION **29.95**

### RAINBOW DISKS

(RED, GREEN, YELLOW, ORANGE, BLACK, WHITE COLORS AND QTY'S OF YOUR CHOICE)

#### 3.5" DSDD DISKS

25 DSDD.....	13.75
50 DSDD.....	26.45
100 DSDD.....	44.95
200 DSDD.....	84.95

#### 5.25" DSDD DISKS

25 DSDD.....	10.45
50 DSDD.....	18.95
100 DSDD.....	34.95
200 DSDD.....	67.95

(ALL DISKS 100% ERROR FREE AND ARE SUPPLIED WITH ENV./LABELS)

TRADE, GOVERNMENT AND  
EDUCATION ORDERS WELCOME

REMEMBER !!! WE ONLY SELL HIGH QUALITY DISKETTES MADE  
BY K.A.O OR ATHANA. WE DO NOT SELL SUB STANDARD  
DISKETTES FROM THE FAR EAST.

MORE THIS WAY TEL 0782 208228 MORE THIS WAY

# MEGA DEALS

## AMAZING OFFERS ON 3.5" DSDD DISKS

25 DSDD 135 tpi .....	11.95
50 DSDD 135 tpi .....	21.95
75 DSDD 135 tpi .....	31.95
100 DSDD 135 tpi .....	37.95

ALL DISKS SUPPLIED WITH LABELS AND ARE 100% ERROR FREE 2 FOR 1 GUARANTEE

## DISK STORAGE BOXES

3.5" 100 CAPACITY.....	5.95
3.5" 80 CAPACITY.....	5.45
3.5" 50 CAPACITY.....	4.95
3.5" 40 CAPACITY.....	4.45
5.25" 100 CAPACITY...	5.95
5.25" 50 CAPACITY...	4.95

**DEDUCT £1.00 FROM  
ABOVE BOX PRICE  
IF PURCHASING  
DISKETTES**

5.25" OR 3.5" 10 CAP BOXES	
5 FOR	4.50
10 FOR	7.50

## GENERAL ACCESSORIES

MOUSE MAT	2.50
MOUSE POCKET	1.50
3.5" DISK CLEAN	1.95
5.25" DISK CLEAN	1.95
ATARI D/COVER	3.95
AMIGA D/COVER	3.95
PRINTER STAND	5.95
MONITOR STAND	12.95
MONITOR PLINTH	19.95

**ALL OUR ACCESSORIES  
ARE OF THE HIGHEST  
QUALITY**



**BANX BOX**  
HOLDS 90 3.5" DISKS  
CAN BE STACKED  
HORIZONTALLY AND VERTICALLY

1.....	9.00
3+.....	8.50
5+.....	8.00

## GENUINE SONY 3.5" DSDD BULK DISKETTES

25.....	12.45	200.....	79.95
50.....	22.95	500.....	179.95
100.....	41.95	1000.....	339.95

(ALL DISKS 100% ERROR FREE AND ARE SUPPLIED WITH LABELS)

## THIS MONTHS SPECIALS

☆☆ OFFER 1 ☆☆  
CUMANA EXT.DRIVE  
PLUS 512K RAM EXP.  
~~86.90~~ **84.95**

☆☆ OFFER 2 ☆☆  
**ACCESORY PACK**  
MOUSE MAT  
MOUSE POCKET  
DISK CLEANING KIT  
DUST COVER  
~~9.90~~ **7.99**

☆☆ OFFER 3 ☆☆  
CUMANA EXT.DRIVE  
PLUS XCOPY PRO  
~~94.90~~ **89.95**

☆☆ OFFER 4 ☆☆  
ZYDEC EXT.DRIVE  
PLUS XCOPY PRO  
~~89.90~~ **84.95**

☆☆ OFFER 5 ☆☆  
200 3.5" DSDD+  
2 100 CAP BOXES  
~~79.95~~ **67.95**



**XCOPY  
PROFESSIONAL**  
(THE ULTIMATE BACKUP UTILITY)

- ☆ FLOPPY DISK BACKUP
- ☆ HARD DISK BACKUP
- ☆ BACKS UP IBM/ST DISKS
- ☆ CHECKS DISKS FOR ERRORS
- ☆ FAST FORMATTING UTILITY
- ☆ INCLUDES HARDWARE FOR EXTERNAL DRIVE BACKUP
- ☆ BACKS UP VIRTUALLY ALL KNOWN DISKS

**THIS UTILITY IS RECKONED  
TO BE THE BEST ON THE  
MARKET**

**ONLY 34.95**



## POSSO BOX

HOLDS 150 3.5" OR 70 5.25" DISKS  
CAN BE STACKED  
HORIZONTALLY AND VERTICALLY

**ONLY 15.95**



**QS138F MAVERICK**  
NEW MICROSWITCH VERSION  
Standard ---  
Autofire 13.95



**SPEEDKING**  
Standard 9.95  
Autofire 10.95



**NAVIGATOR**  
Standard ---  
Autofire 13.95



**ZIPSTICK**  
Standard 11.95  
Autofire 13.95



**COMP. PRO 5000**  
Standard 11.95  
Autofire 13.95



**MANTA RAY**  
Standard 12.95  
Autofire 14.95



**STING RAY**  
Standard 14.95  
Autofire 15.95



**QS131 APACHE**  
Standard 6.95  
Autofire ---



**QS130F PYTHON I**  
NEW MICROSWITCH VERSION  
Standard ---  
Autofire 9.95

MORE THIS WAY  TEL 0782 208228  MORE THIS WAY 



# THE NAKSHA SCANNER

FOR ALL AMIGA A500 COMPUTERS

400 dpi 32 GREY SHADE HANDHELD SCANNER

## PACKAGE INCLUDES:-

- ★ Naksha A500 Scanner
- ★ Interface
- ★ Power Supply
- ★ Data scan professional software "the ultimate scanner software"

# Naksha

**ONLY 129.95**

## STAR PRINTERS

### STAR LC10 120/25 cps 159.95

Multiple font options  
Simultaneous, continuous  
and single sheet stationary

Excellent paper handling facilities  
240 X 240 dpi Graphics

### STAR LC24-10 180/60 cps 214.95

Exceptional letter quality print  
8 resident fonts

Additional font cartridges available  
360 X 360 dpi Graphics

### STAR LC200 COLOUR 214.95

240 dpi 9 pin colour printer  
8 resident fonts  
16 kb buffer  
185/40 cps

Additional font cartridges available  
360 X 360 dpi Graphics  
Supplied with colour and mono ribbons  
Front pannel pitch selection

### STAR LC24-200 MONO 259.95

360 dpi 24 pin mono printer  
10 resident fonts  
7 k buffer expandable to 39k  
220/55 cps

Additional font cartridges available  
Supplied with mono ribbon  
Front pannel pitch selection

### STAR LC24-200 COLOUR 309.95

360 dpi 24 pin colour printer  
10 resident fonts  
30k buffer expandable to 62k  
220/55 cps

Additional font cartridges available  
Supplied with mono and colour ribbons  
Front pannel pitch selection

## PRINTER RIBBONS

	1	5
STAR LC10 MONO	2.95	13.25
STAR LC10 COL.	5.95	26.75
STAR LC24-10	4.95	22.25
STAR LC200 MONO	5.50	24.75
STAR LC200 COL.	10.95	49.25
STAR LC24 200 MONO	4.95	22.25
STAR LC24 200 COL.	11.95	53.75

WE STOCK A LARGE RANGE OF RIBBONS FOR ALL TYPES OF PRINTER IF YOU DONT SEE YOURS LISTED CALL US FOR A QUOTE

## ABACUS BOOKS

Advanced system programmers guide	32.45
Amiga 3D graphics basic programming	18.45
Amiga basic inside and out	18.95
Amiga C advanced programmers	32.45
Amiga C for beginners	18.45
Amiga DOS inside and out	18.45
Amiga dos quick reference	8.95
Amiga desktop video guide	18.45
Amiga disk drives inside and out	27.95
Amiga for beginners	12.95
Amiga machine language	14.95
Amiga printers inside and out	32.95
Amiga system programmers guide	32.95
Best amiga tricks and tips	27.45
Making music on the amiga	32.95

## PHILLIPS CM 8833/II STEREO COLOUR MONITOR



THIS SUPERB STEREO COLOUR MONITOR ONLY **£244.95**

## THE ALL NEW AMIGA CORDLESS MOUSE

SO NEW WE CAN'T EVEN SHOW YOU A PICTURE

THIS AMAZING MOUSE HAS NO LEAD TO GET TANGLED

A STAR BUY AT ONLY

**£24.95**

CALL FOR MORE INFO.



LOW COST AMIGA/ATARI REPLACEMENT MOUSE ONLY 14.95

## HOW TO ORDER

**BY POST.** Print name and address and order requirements and a daytime telephone number if possible. Enclose a personal cheque, bankers draft, building society cheque, or postal order made payable to MEDIA DIRECT C.S.Ltd. Please note cheques require 5 working days for clearance.

**FAX 0782 281506** As post but include credit card number, expiry date and cardholders full address for immediate despatch.

**DELIVERY SERVICE.** Please add £3.35 for standard delivery or £9.00 for next working day delivery. **UK mainland only** (excluding highlands)

## TELESALES HOTLINES :-

**0782 208228**



MEDIA DIRECT C.S.Ltd  
dept AFT UNIT 3  
RAILWAY ENT.CENTRE  
SHELTON NEW ROAD  
STOKE ON TRENT  
STAFFS  
ST4 7SH

## COME AND VISIT OUR SHOWROOM

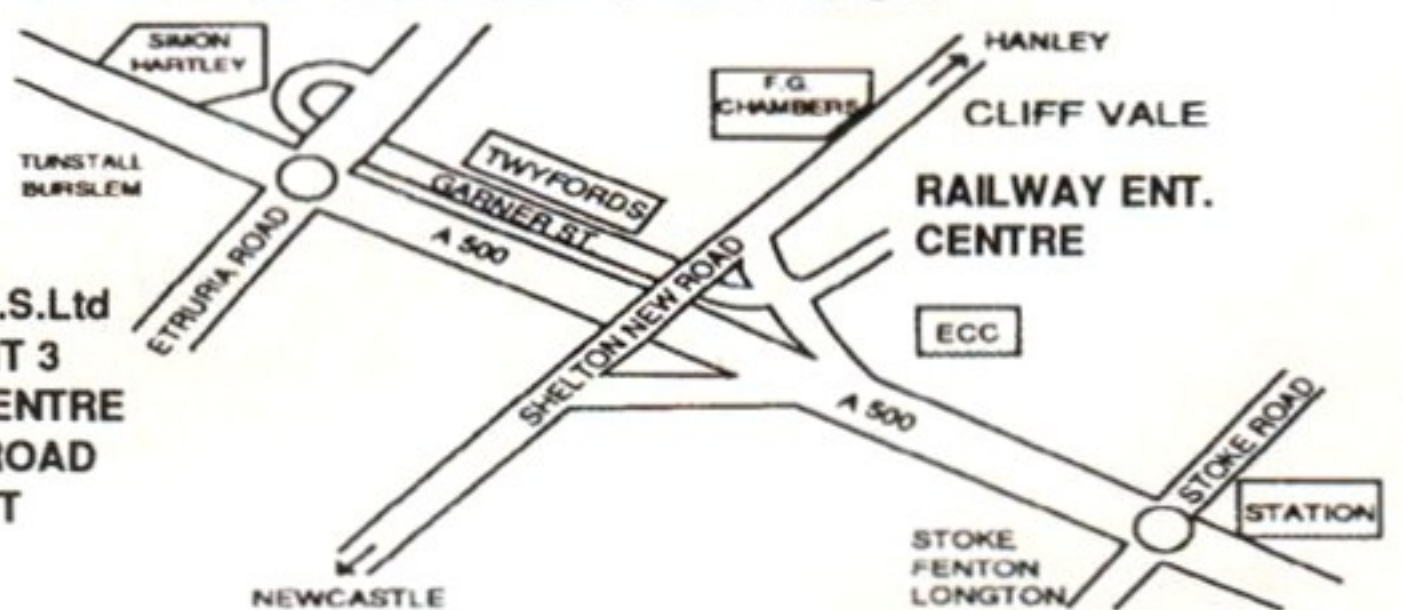

TO M6 J15

# POST HASTE

ALL PRICES INCLUDE VAT & DELIVERY TO YOUR DOOR!

Select any 3 titles valued at £7.99 or less and you pay only £20

<b>SOFTWARE</b> <i>The following games titles are limited offers at the time of going to press. Please order early to avoid disappointment!</i>  <i>We stock all the latest and currently available titles which we offer at 30% OFF of recommended retail price!</i>		Indiana Jones+Zak McKracken 12.99 James Pond 7.99 Jocky Wilsons Darts 6.99 Jumpin Jackson 7.99 Keef the Thief 7.99 Klax 7.99 Last Ninja 2 6.99 Leather Goddesses of Phobos 7.99 Legend of Djei 6.99 Lombard RAC Rally 6.99 Loom 12.99 Neuromancer 7.99 Ninja Rabbit 5.99 Ninja Remix 7.99 Ninja Spirit 7.99 Overlander 6.99	Wacky Darts 5.99 Warhead 7.99 Wheels of Fire Compilation 12.99 White Death 12.99 Wind Walker 7.99 Wings 512k 16.99 Wierd Dreams 7.99 Winning Tactics 6.99 Wishbringer 7.99 World Class Leaderboard 6.99 World Cup Year 90 Compil. 9.99 X-Out 7.99 Xenon 6.99 Xenon II 7.99 Yogi's Great Escape 6.99 Zork 7.99 Zork III 7.99	Cashbook/Final Accounts 44.99 Personal Tax Planner 29.99 Personal Finance Manager 21.99 Small Business Accts Cash 59.99 Small Business Accts Xtra 79.99 <b>GRAPHICS</b> Deluxe Paint 3 54.99 Photon Paint 6.99 Deluxe Photolab 49.99 Moviesetter 39.99 Real Things Birds 24.99 Real Things Humans 24.99 Real Things Horses 19.99 ProFills 24.99 Pixmate 37.99 Butcher 27.99 The Art Department 49.99 The Art Department Pro. 134.99 Kara Anim Fonts 1 29.99 Kara Anim Fonts 2 29.99 Kara Anim Fonts 3 29.99 Kara Fonts Headlines 1 49.99 Kara Fonts Headlines 2 44.99 Kara Fonts Sub Headlines 44.99 <b>3D MODELLING &amp; RENDERING</b> Sculpt 3DXL 84.99 Sculpt Animate 4D 229.99 Vista 42.99 Vista Professional 69.99 Imagine 189.99 3D Professional 349.99	Dinosaur Discovery Kit 17.99 Distant Suns (Astronomy) 32.99 Deep sky Objects 14.99 Skymap Expansion 14.99 First letters 6.99 First Letters & Words 17.99 Fun School II (2-6) 14.49 Fun School II (6-8) 14.49 Fun School II (Over 8s) 14.99 Fun School III (Under 5s) 17.49 Fun School III (5-7) 17.49 Fun School III (Over 7s) 17.49 Game Set and Match 13.99 Gooly's Railway 17.40 Henrietta's Book of Spells 17.49	<b>CDTV</b> Now in Stock only £569 10% OFF all CDTV Software!	<b>SERIOUS</b> <b>VIDEO</b> Photon Video (Cel Animator) 14.99 Deluxe Video III 59.99 Aegis Animagic 59.99 Broadcast Titrer 2 174.99 AmigaVision 89.99 Scala 174.99 TV Text Professional 89.99 TV Show 2 49.99 Videotitrer 1.5 3D 69.99 <b>WORDPROCESSING</b> Scribble Platinum 39.99 Kindwords 2 39.99	<b>CANON BJ10E BUBBLEJET.</b> Near Laser Quality £289 Including Amiga Printer Driver & Lead!	10% OFF all CDTV software 589 A590 20Mb Hard Drive 279 A590 20Mb H/Drive+2Mb RAM 359 Trumpcard 500 40Mb H/Drive 539 Trumpcard 2000 40Mb H/Drive 519 45Mb Hardcard A2000/A1500 349 90Mb Hardcard A2000/A1500 499 135Mb Hardcard A2000/A1500 575 173Mb Hardcard A2000/A1500 649 45Mb SCSI Hard Disk (Bare) 199 90Mb SCSI Hard Disk (Bare) 359 135Mb SCSI Hard Disk (Bare) 449 173Mb SCSI Hard Disk (Bare) 499 Qumana 3.5" External Drive 59 Zydec 3.5" External Drive 55 RF 5.25" External Drive 99 CBM 3.5" Internal Floppy Drive 119 512k Ram Expansion no clock 25 512k Ram Expansion + clock 29 1.5 Mb Ram Expansion 89 A2000/1500 8Mb Ramcard 189 256kx4 RAM chips per Mb 35 1Mbx1 DRAM chips per Mb 35 CBM 68030/68882 25Mhz 899 Colour Solution(Vidi+RGBsplit) 159 Sharp JX100 A6 Col. Scanner 625 Sharp JX300 A4 Col. Scanner 2750 Golden Image Hand Scanner 175 Podcat Graphics Tablet 199 Zydec Microswitched Mouse 17
<b>GAMES</b> 3D Construction Kit 32.99 3D Pool 7.99 Afterburner 6.99 Anarchy 6.99 Antheads 9.99 Atomic Robokid 6.99 Balance of Power 6.99 Barbarian (Palace) 6.99 Batman 7.99 Battlemaster 6.99 Bionic Commando 6.99 Blitzkrieg 12.99 Boulderdash Con/Kit 4.99 Cape 'n' Carnage 6.99 Captain Fizz 4.99 Carrier Command 9.99	<b>A590 Upgrades</b> 45Mb.....£229 90Mb.....£389 135Mb.....£479 173Mb.....£529 All prices include fitting, formatting & return postage!!!	<b>FAST FIXED PRICE COMPUTER REPAIRS</b> AMIGAS (Excluding Keyboard, Disk Drive and Fat Agnus).....£45 Atari STs (Excluding Keyboard and Disk Drive).....£45 Commodore C64s (Excluding Keyboard).....£35 All prices include return postage!	Pacland 7.99 Pacmania 7.99 Planetfall 7.99 Powerdrome 7.99 Powerplay 4.99 Predator 6.99 Pro Boxing Simulator 6.99 Pub Trivia 4.99 R-Type 6.99 Raider 4.99 Roadblasters 6.99 Ruff 'n' Ready 6.99 Shufflepack Cafe 6.99 Shadow of the Beast 9.99 Silkworm 6.99	<b>AMIGAS</b> 500s from £319 1500/2000s from £649 3000s from 2099	<b>512k RAM EXPANSIONS</b> only £25 £29 with Clock!	<b>AMIGAS</b> 500s from £319 1500/2000s from £649 3000s from 2099	Hooray for Henrietta (5-12) 17.49 Junior Typist (5-10) 12.49 Kid Talk 17.99 Kid's Type 17.49 Lets Spell at Home 14.49 Lets Spell at the Shops 14.49 Mickey's Runaway Zoo 17.49 Magic Maths (4-8) 16.49 Maths Mania (over 8) 16.49 Math Talk Fractions 17.99 Mavis Beacon Teaches Typing 20.49 Mix & Match 17.49 Prof Hunts for Words 17.99 Prof Looks Words 17.99 Prof Makes Sentences 17.99	<b>Panasonic KX-P4420 Laser Printer</b> only £849 <b>HP Paintjet colour inkjet printer</b> only £825	
Centrefold Squares 7.99 Chaos Strikes Back 14.99 Chase HQ II 9.99 Chuckie Egg 7.99 Chuckie Egg II 7.99 Classic 4 5.99 Colossus Chess X 7.99 Corporation & Mission Disk 12.99 Cosmic Pirate 6.99 Datastorm 6.99 Defender of the Crown 7.99 Deluxe Strip Poker 7.99 Double Dragon 6.99 Double Dragon II 7.99 Dragon Breed 6.99 Drivin Force 4.99 Dungeon Quest 6.99 Dynasty Wars 6.99 E-Motion 4.99 Elite 14.99 Enchanter 7.99 Exolon 4.99 FA-18 Interceptor 8.99 Falcon Missions Vol 1 7.99 Fantasy World Dizzy 5.99 Fast Food Dizzy 5.99 Fast Lane 4.99 Fernandez Must Die 4.99 Ferrari Formula One 7.99 Full Contact 7.99 Gauntlet 2 6.99 Grand Monster Slam 6.99 Hard Drivin' II 9.99 Hitchhikers Guide to the Galaxy 7.99 Hong Kong Phooey 6.99 Hostages 6.99 Impossible Mission II 6.99	Interword 39.99 Penpal 69.99 Excellence 2 89.99 Protexit 4.2 74.99 Protexit 5.0 109.99 ProWrite 3.1 99.99 Word Perfect 4.1 159.99 Word Perfect Library 79.99 Wordworth 89.99 <b>SPREADSHEET</b> Advantage 79.99 DG Calc 28.99 <b>DATABASES</b> Infofile 34.99 Superbase Personal 2 69.99 Superbase Professional 149.99 Superbase Professional 4 299.99 <b>INTEGRATED (WP/SS/D/B)</b> The Works Platinum 59.99 Gold Disk Office 109.99 <b>DTP</b> Pagesetter 2.0 52.99 Pro Page 1.3 99.99 Pro Page 2 199.99 Pro Draw 2 99.99 Outline fonts 99.99 Gold Disk Fonts 1-4 34.99 Structured Clip art 39.99 Eclips 79.99 Proclips 17.99 Deluxe Print II 34.99 <b>CAD</b> X-CAD Designer 74.99 X-CAD Professional 159.99 Aegis Draw 2000 99.99 <b>ACCOUNTS</b> Home Accounts 27.99	Real 3D Beginners 109.99 Real 3D Professional/Turbo 299.99 <b>PROGRAMMING</b> AMOS 32.99 AMOS Compiler 20.49 Devpac 2 49.99 Lattice C 219.99 Hisoft Basic 57.99 Hisoft Basic Extend 14.49 <b>MUSIC</b> Deluxe Music Const. Set 49.99 Quartet 35.99 Mastersound sound sampler 29.99 Music X Junior 74.99 Tiger Cub+Midi Interface/leads 79.99 Bars & Pipes Professional 174.99 <b>MISCELLANEOUS</b> BAD Disk Optimiser 34.99 Cross Dos 4 29.99 Dos 2 Dos 39.99 Disk Master 39.99 FacII 24.99 GB Route 34.99 Icon Paint 9.99 Quarterback H/ Disk Backup 49.99 Quarterback Tools 59.99 Byte 'N' Back H/ Disk Backup 18.99 <b>EDUCATIONAL</b> Answerback Junior 14.49 Answerback Senior 14.49 Arithmetic (Answerback facts) 7.49 Ass. Football (Answerback facts) 7.49 Spelling (Answerback facts) 7.49 Better Maths (12-16) 16.49 Better Spelling (over 8) 16.49 Three Bears 16.49 Donald's Alphabet 17.49	Naksha Mouse 19 Turbo Mouse 12 Mouse Mat 4 50 Blank Disks 20 <b>ATARI STs</b> 520ST Discovery Pack 259 520STE Discovery Pack Extra 279 520STE with 2Mb RAM 369 520STE with 4Mb RAM 459 1040STE Family Curriculum 369 Mega STs POA STACys POA 512k expansion for 520STE 29 512k expansion for 520STFM 49 1Mb External Floppy Drive 54 1Mb Internal Floppy Drive 59 Zydec Microswitched Mouse 17 Naksha Mouse 19 Mouse Mat 4 50 Blank Disks 20 <b>MONITORS</b> All monitors include leads Philips 8833-II 239 Commodore 1084s 254 Commodore 1950 Multisync 499 <b>PRINTERS</b> All printers include leads and AMIGA PRINTER DRIVERS Star LC200 Colour 219 Star LC24-200 Mono 259 Star LC24-200 Colour 299 888 Citizen Swift 9 Colour 199 Citizen Swift 24 Colour 299 Canon Bubblejet Portable 289 HP Paintjet Colour Inkjet 825 Panasonic 4420 Laser 849 Panasonic 4420 1Mb Upgrade 199						

You name it... We do it... Just phone and we'll quote... We are faster and cheaper!

PRICES QUOTED ARE SUBJECT TO AVAILABILITY.. SOME OFFERS ARE LIMITED SO ORDER EARLY TO AVOID DISAPPOINTMENT  
 Cheques/PO Orders to POST HASTE, 11a Burgate Lane, Canterbury, Kent. CT1 2HH

TELEPHONE HOTLINE 0227-764204 9.30am to 7.00pm



(Answerphone outside normal hours)

VISA, MASTERCARD and EUROCARD orders welcome

Visa, Mastercard, Eurocard and PO Orders are despatched same day!

Please allow up to 4 working days for cheques to clear. Overseas orders add £2.00 postage.

MAIL & TELEPHONE ORDERS ONLY.... NO PERSONAL CALLERS PLEASE!





**YOU COULD BE FORGIVEN** for thinking the Concept Keyboard is some new idea in multi-voice, polyphonic, velocity sensitive MIDI keyboards as it costs the thick end of 250 quid. Sorry, music fans: this is one item of hardware that won't help you arrange The Planets Suite in one movement. But it will enhance just about every application that requires QWERTY keyboard input.

The original Concept Keyboard, designed by the then Star Microterminals, started life almost ten years ago as a Special Needs education peripheral for the Acorn BBC Micro. The idea was to provide an input device usable by children and adults with limited co-ordination or cognitive abilities.

The problem is that such people can have difficulties using conventional methods of communicating with a computer because they often cannot manipulate a keyboard accurately or more frequently even read the letters. Even the mouse, another recent innovation, requires a certain amount of co-ordination. Similarly, touch sensitive screens are rarely accurate enough to be of any use. This left programmers (and at the time I was doing just that) with a paradox; how do you design a program to educate people who cannot easily respond to questions?

**UNTIL QUITE RECENTLY**, people were taught by the 'rote' method, where subjects are taught by constant repetition of information. This can be applied to many areas of education because little or no user interaction is required - except for testing. If you have memories of "two twos are four, three twos are six, four twos are eight" echoing round the classroom then you were probably taught by rote.

The Concept Keyboard changed all that with an impact that was felt throughout Special Needs education. Quite simply it was a breath of fresh air, opening doorways no-one even imagined possible. However, when the BBC Micro developed into the powerful - and expensive - Archimedes, the idea was almost lost for all time.

Interestingly, in the early development stages of Commodore's BBC Emulator, it was suggested a hardware add-on - to emulate the BBC's User Port - should be designed to make use of existing BBC hardware such as the Concept Keyboard. This was eventually decided to be too expensive so when Star Microterminals (now The Concept Keyboard Company) decided to develop the keyboard for the Amiga, they had to choose a different method of interfacing.

**SO HOW DOES IT WORK?** The Concept Keyboard is, in essence, a plain keyboard with, 128 or 256 individually programmable, touch-sensitive areas. One obvious advantage of this design is its robustness and resistance to spilt cups of tea.

The whole thing initially looks like an odd idea, but in effect you have a touch sensitive area with a resolution of 16-by-8 or 16-by-16. This allows you to design keyboard layouts ('overlays') tailored to the needs of individual programs. Overlays can be anything from numbers and letters to pictures: anything. One

Not everyone finds the Amiga easy to use, but a new kind of input device promises to change all that by allowing access to all.

**Mark Smiddy** pushes the button that opens doors for people with special needs.

The Concept Keyboard may look like a turbo-charged ZX81 - but looks can be very deceiving.



# Concept Keyboard

Programmable Keyboard ■ £246.40 ■ Concept Keyboard Company

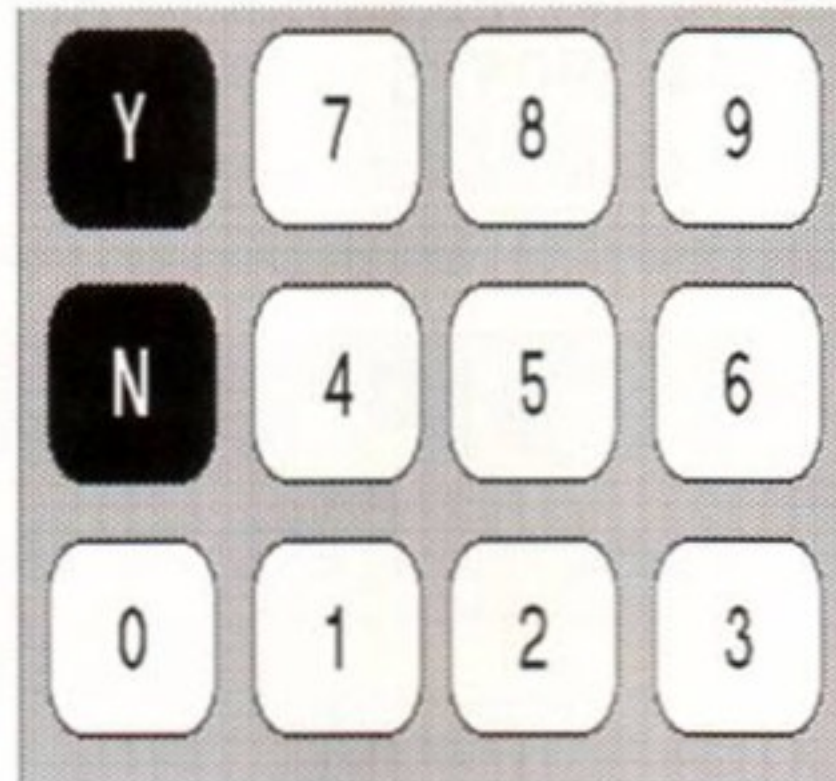

enterprising programmer I know, created overlays by sticking real objects - coins, cut-outs and the like - to overlay sheets and using them in educational programs.

**WHAT MAKES IT SPECIAL** is the incorporation of an overlay manager. This allows anyone to design overlays and use them with existing software. The system works well with almost anything that can be run from the Workbench or CLI, though auto-booting software cannot be used. The overlay designer is, to say the least, very clumsy, but a new version is said to be imminent.

I tried the keyboard with AMOS-created programs like Treasure Hunt (AMOS PD) and Hooray For Henrietta (Scetlander) plus Kosmos', Answer Back Quiz. Although the AMOS stuff had to be started from a CLI, it proves the keyboard works, and works well, opening up a vast range of existing applications to special needs clients. I wonder who will be the first to incorporate a Concept Keyboard interface as standard?

For the sake of old-timers and new users alike, the new unit does not rely on the old design's use of a hardware bus, using the

existing serial port hardware instead. Although the port only supports a fairly slow baud rate (4800) it is quite fast enough to cope. Although a lot of existing software can benefit from the Overlay Designer, writing software for the keyboard is theoretically simpler than ever before.

Since the 23 way "D" serial connector is now standard on all major micros, production should hopefully go up allowing the still prohibitive price to come down. By the middle of 1992, if sales are proceeding as planned, the A3 size model will become a reality. In any event, the existing A4 unit is functionally at least as good as the original and it looks better, too. Also, bona-fide educational establishments can enjoy the benefits of a special discount scheme. Any Amiga owner with physically or mentally disadvantaged children would be well advised to look at this.

AF

**THE CONCEPT KEYBOARD**  
£246.40  
(£178.25 plus VAT for educational users only)  
HB Marketing  
Unit 3, Poyle 14,  
Newlands Drive,  
Colnbrook, Slough  
SL3 0DX.  
0753 686000

**THE CONCEPT KEYBOARD COMPANY LTD.**  
Moorside Road,  
Winnall Industrial Estate, Winchester,  
Hampshire SO23 7RX.  
0962 843322

## Product Name

### SPEED

At just 4800 baud, it could hardly be called a fast serial device... ● ● ●

### DOCUMENTATION

The overlay designer's is borderline; the user guide is good though. ● ●

### ACCESSIBILITY

The appalling software interface contrasts with the brilliant hardware like coal in a blizzard. ● ● ● ● ●

### FEATURES

A fairly wide range of options - for those prepared to program. ● ● ● ● ●

### VALUE

Most readers will have no use for this device whatsoever. Those that do will find it invaluable. ● ● ●



# 85%





# CONNECT International



Dept AMFSCI, Grange Farm, Abbots Ripton, Huntingdon, Cambs. PE17 3PW

**ORDER HOTLINE: 0487 3343 FAX: 0487 3525**

## PROFESSIONAL SOFTWARE FOR YOUR AMIGA

### ACCOUNTS

Arena Accounts .....	134.99
Home Accounts .....	22.99
Personal Accounts + .....	28.99
Small Business Accounts Edu .....	65.99

### DATABASES

K Data .....	35.99
Superbase Personal 2 .....	29.99
Superbase Prof 4 .....	299.99

### EDUCATIONAL

Fun School 2 Under 6 .....	13.99
Fun School 2 6-8 .....	13.99
Fun School 2 Over 8 .....	13.99
Fun School 3 Under 5 .....	16.99
Fun School 3 5-7 .....	16.99
Fun School 3 Over 7 .....	16.99
French Mistress .....	13.99
German Master .....	13.99
Italian Tutor .....	13.99
Mavis Beacon Teaches Typing .....	19.99
Spanish Tutor .....	13.99
Spell Book 4-9 .....	14.99
Things to do with Numbers .....	14.99
Things to do with Words .....	14.99

\* Product not yet released  
All prices include VAT. All goods  
subject to availability. Prices subject  
to change without notice. E&OE

### GRAPHICS/ANIMATION

Amos .....	32.99
Deluxe Paint 3 .....	59.99
Deluxe Paint 4 .....	79.99
Deluxe Photolab .....	49.99
Deluxe Print 2 .....	34.99
Deluxe Video 3 .....	59.99
Digimate 3 .....	25.99
Digipaint 3 .....	59.99
Digiview Gold .....	89.99
Disney Animation Show .....	59.99
Movie Setter .....	49.99
Photon Video .....	24.99
Pixmate .....	34.99
Photon Paint 2 .....	19.99
Professional Draw 2 .....	96.99
Spectra Colour .....	57.99
Tiger Cub .....	57.99

### SPREADSHEETS

Advantage .....	62.99
Digicalc .....	27.99
K Spread 3 .....	76.99
Maxiplan 500 .....	39.99
Superplan .....	39.99

### MUSIC/SOUND

Amas .....	79.99
Audio Master 3 .....	47.99
Bars + Pipes Prof .....	154.99
Deluxe Music Cons Set .....	49.99
Mastersound .....	32.99
Music X .....	89.99
Music X Junior .....	49.99
Perfect Sound 3 .....	64.99
Quartet .....	21.99
Sonix .....	49.99
Soundtrap 3 .....	39.99
Techno Sound .....	34.99

### WORDPROCESSORS/DTP

Excellence V2 .....	99.99
Kindwords 2 .....	29.99
Pagesetter .....	49.99
Pagestream 2 .....	149.99
Pen Pal .....	85.99
Professional Page V2 .....	179.99
Protext 5.0 .....	109.99
Prowrite 3 .....	109.99
Quickwrite .....	43.99
Scribble .....	42.99
Transwrite .....	59.99
Wordsworth .....	109.99

### UTILITIES/PERIPHERALS

1/2 Meg upgrade with clock .....	34.99
1/2 Meg upgrade without clock .....	29.99
3.5" DSSD (10) .....	9.99
Amiga 500 Duss. Cover .....	3.99
Disk Cleaning Kit .....	2.99
Mouse Mat .....	4.99
Naksha Mouse .....	21.99
Devpac 2 .....	44.99
Digiview .....	119.99
Hi Soft Basic .....	59.99
Lattice C V5 .....	169.99
Vid Amiga + Vid Chrome .....	109.99
Vid Chrome .....	16.99
Vid RGB Splitter .....	64.99

### JOYSTICKS

Comp Pro Black .....	10.99
Comp Pro Extra Clear .....	13.99
Comp Pro Combat Extra .....	12.99
Comp Pro Star Extra .....	13.95
Quickshot Python .....	9.99
Quickshot Apache .....	5.99
Quickshot Flight Sim .....	9.99
Quickshot Maverick .....	13.99
Quickshot Topstar .....	19.99
Quickshot Jetfighter .....	12.99

### STRATEGY/SIMULATIONS

A10 Tank Killer .....	22.99
F19 Stealth .....	19.99
F29 Retaliator .....	16.99
F15 Strike Eagle 2 .....	22.99
Flight Simulator 2 .....	23.99
M1 Tank Platoon .....	19.99
Mig 29 .....	19.99
Sim Earth .....	19.99
Team Yankee .....	19.99
UMS 2 .....	20.99
Wolf Pack .....	12.99

### HOW TO ORDER



ORDER BY PHONE: Phone our order hotline (0487 3343) with your Access/Visa card quoting card number, name of holder, and expiry date.



ORDER BY POST: cheques or postal orders payable to "CONNECT INTERNATIONAL". Please send name, address and daytime telephone number along with your order req.



FREE POSTAL DELIVERY (£1 overseas)  
Please allow up to 28 days delivery.



62 Tenter Road, Moulton Park  
Business Centre, Northampton,  
NN3 1AX, England

**Tel: (0604) 790466**

**Fax: (0604) 647403**

## THE GENLOCK PEOPLE

Do you want to overlay computer graphics or titles onto your videos? If so, you will need a Genlock. Rendale Genlocks are built to a very high standard, and are used widely in the professional environment. Each of the Rendale machines offers both foreground and background modes, the 8802 is a purely composite machine, the 8806 also offers a professional RGB mix option, as well as other advanced features. Do not be fooled by cheaper versions of our Genlocks which are presently on offer, buy direct from the manufacturer or an approved supplier. Please call for further details.

**GENLOCKS**  
RENDALE 8802  
£199.99  
RENDALE 8806  
£862.50

**MODE**  
**SWITCHBOX**  
**FOR THE**  
**RENDALE 8802**  
Only £34.99

## SUPER-VHS GENLOCK

At last, the Rendale Super-8802 is available. As well as operating in a similar fashion to the standard 8802, the Super-8802 also boasts the following:

- Super-VHS both in and out.
- Hardware controlled fades.
- Hardware controlled wipes.
- Cross fade between Amiga and video.
- Integral mode switching control.

**RENDALE SUPER-8802 £599.99**

Existing Rendale 8802 users can also upgrade. Please telephone Fiona for a date to send your unit to us. We will require it for around two days.

**RENDALE SUPER VHS UPGRADE £420.00**

Fractal graphics techniques and 24-bit colour combine to allow you to create three-dimensional landscapes of stunning realism. **Paul Lyons** shapes the land...

# VistaPro

Fractal scenery generator ■ £79.99

Virtual Reality Labs

NOT JUST A FLY-AROUND landscape toy, this. Virtually every feature of a vista is user-definable. Change the angle, direction and intensity of the lighting; add rivers, lakes and raise or lower the sea level; change the colours of the land and sky; move the tree and snow lines; smooth, shade or sharpen the landscape.

The way *VistaPro* works is by taking the US Geological Survey Digital Elevation Models (USGM DEMs) and rendering them using its own version of artificial intelligence. A number of these landscapes are provided with the program and literally hundreds more are available from as *Vista Scenery Disks*.

However, *VistaPro* also has a fractal landscape generator which creates scenery just as spectacular as anything on Earth. If you just change the seed number, *Vista* will create over four billion different fractal landscapes from islands to canyons.

The rendering of a landscape is really very simple. Using the mouse, you position the camera (your viewpoint) and the target (the point you want to look towards). Decide what resolution you want to render at, and click the Render button.

If you have an A500 at this point you should go and get something to eat, have a bath, watch some TV and perhaps visit a few friends. The point I'm trying to get across here is that it's slow. Much faster than the original

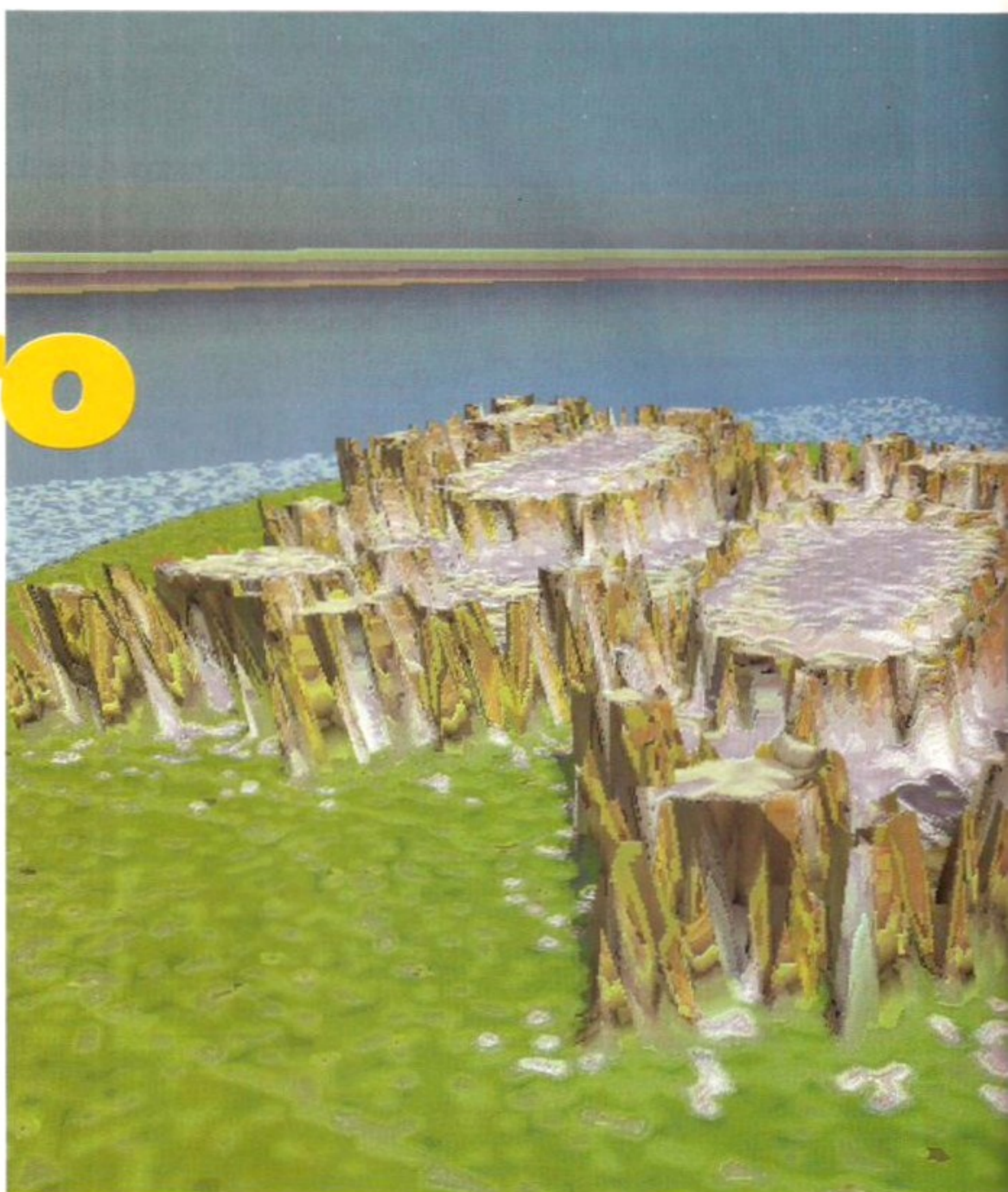

This is how a *VistaPro* image looks when it is rendered in the maximum possible resolution with all the tweaks turned on and output as 24-bit colour to a Postscript device. It's pretty stunning.

*Vista* it may be, but on high resolution it takes a seriously long time to render on an A500. The high-resolution 24-bit images on these pages took well over an hour to render on a standard A2000.

If you need extra speed more than you need extra cash there are ways to decrease the time it takes to render an image. Because creating three-dimensional landscapes is a very maths-intensive task, the addition of an accelerator board with a maths co-processor can reduce rendering times of 80+ minutes to less than five.

Rendering an image in detail is a serious undertaking and unsurprisingly *VistaPro* does not work in real time. However, the program has a built-in animation scripting system that allows you to create high resolution HAM fly-throughs of a landscape.

To create an animation you first set up the landscape just as you would for a single-frame render. Once you're sure of the colours and lighting, you create a script – a list of different camera and target positions – by simply moving the target and/or the camera very slightly and saving the new position.

**VistaPro**  
**£79.99**  
**HB Marketing**  
**0753 686000**

## BUY YOURSELF A PIECE OF MARS

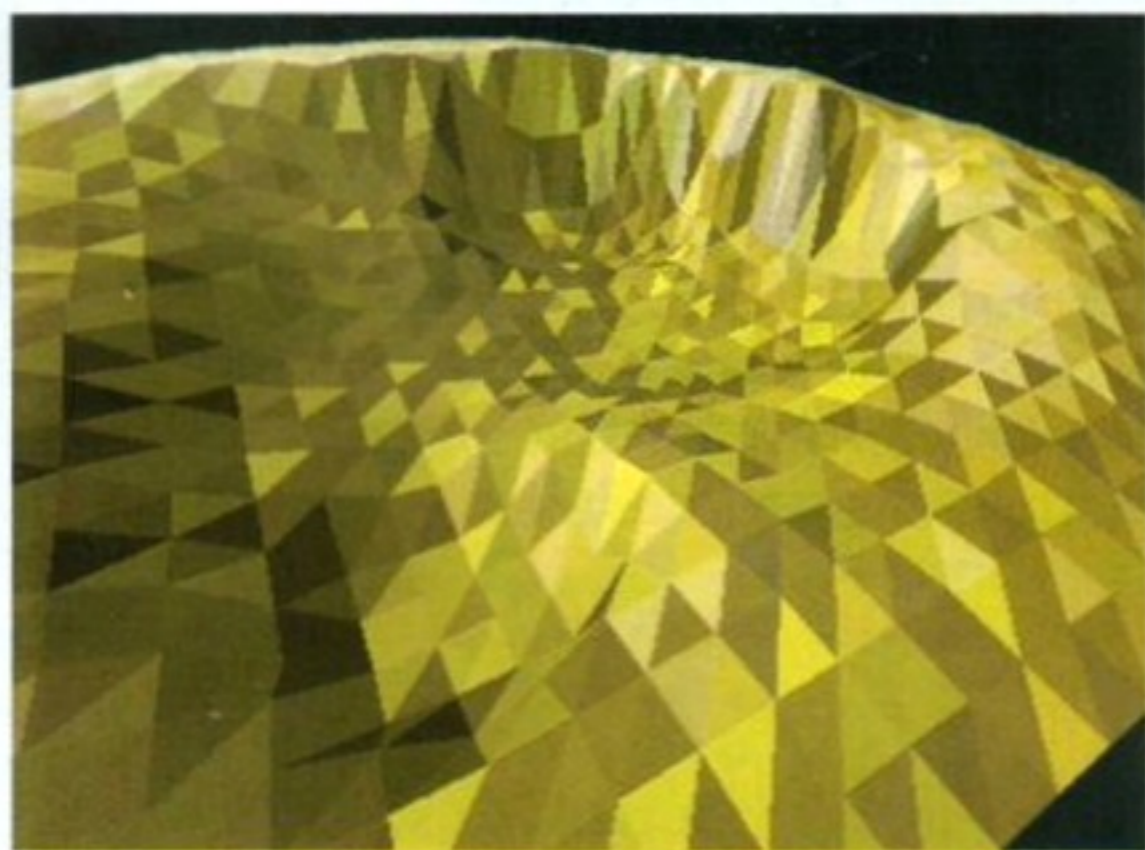

If you tire of the landscapes provided with *VistaPro* (and the four billion others that can be created using the in-built fractal generator), there are literally hundreds more available on disk from the UK Distributors, HB Marketing. Scenes are as wide and various as the Moon, the Grand Canyon and large chunks of the Rocky Mountains. Plans are afoot to have a set of UK landscapes created, but as yet there is no date fixed. Really keen Vistarians can obtain the Vista DEM format specifications to create their own landscapes by sending \$5 to VRLI in California.

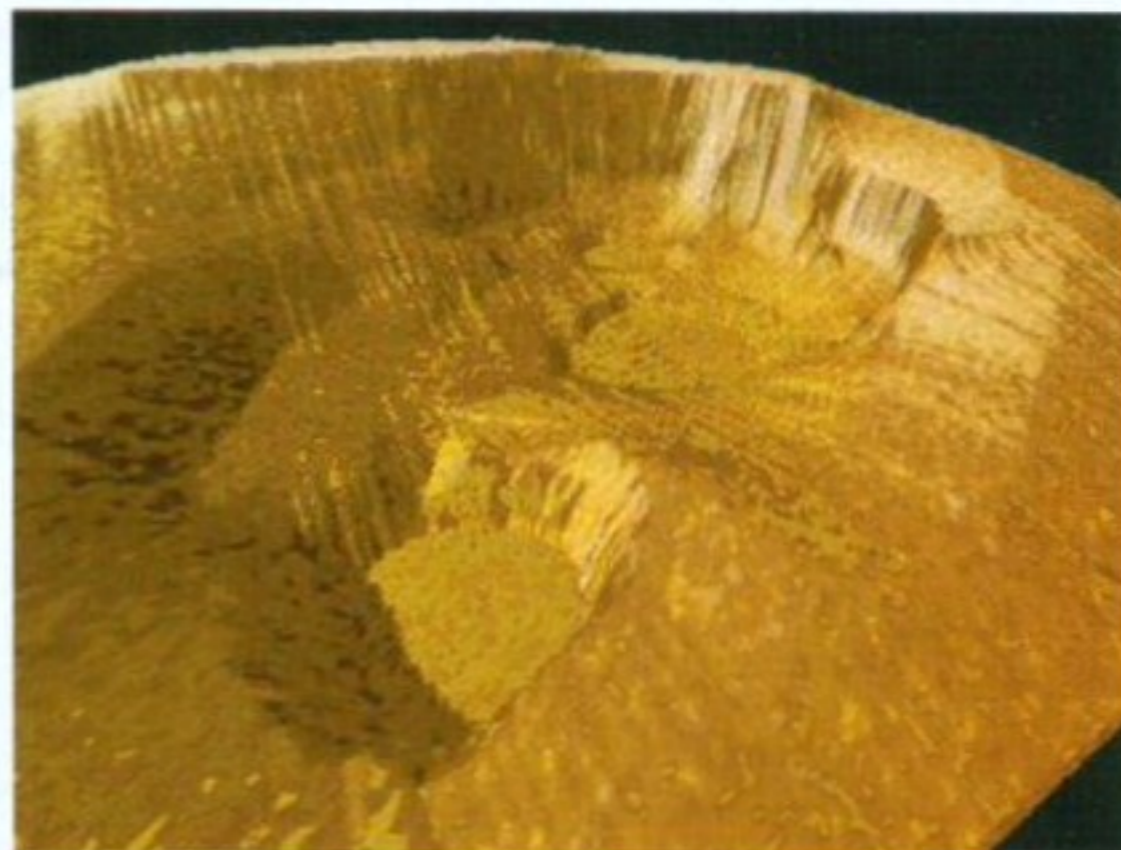

## CREATING LANDSCAPES IN FOUR EASY STEPS.

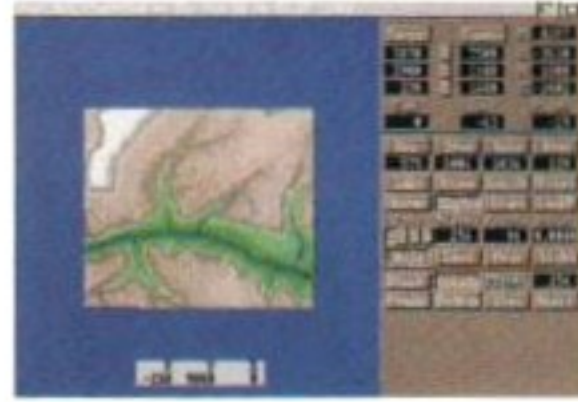

**ONE:** Open *VistaPro* and load a map in from disk, or click on the fractal control to generate a artificial mathematical one. Move the target and camera to the desired position in space and enter the desired

heights in the dialogue boxes on the left. Add rivers, lakes, waterfalls and sea by clicking the correct button and clicking on the map where you want the feature to start. Sea raises the sea level to that point; lakes fill the surrounding area to that point; rivers start at that point and run downhill forming lakes where the water pools.

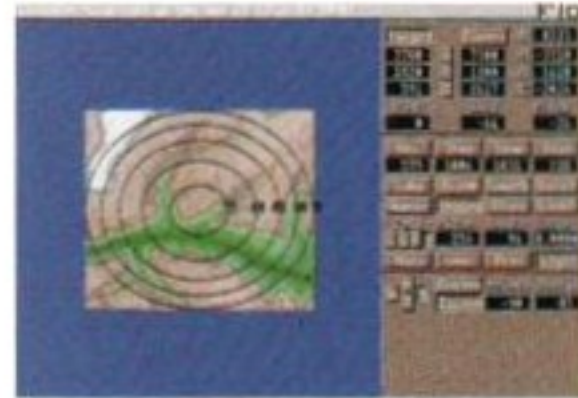

**TWO:** Click on the lighting panel and adjust the angle and direction of the light using the mouse. Adjust the angle of view using the lens control.



**THREE:** Do a low-resolution test render to check the angle and lighting by selecting '8' on the render panel. Repeat stage two as necessary until you are satisfied with the result.

**FOUR:** Set the resolution at the desired level and add Blend, Smooth and Gouraud Shading as necessary (these are added last because they greatly increase the rendering time). Click Render, wait and there you have it - in this case a large chunk of the Grand Canyon appears before your very eyes.

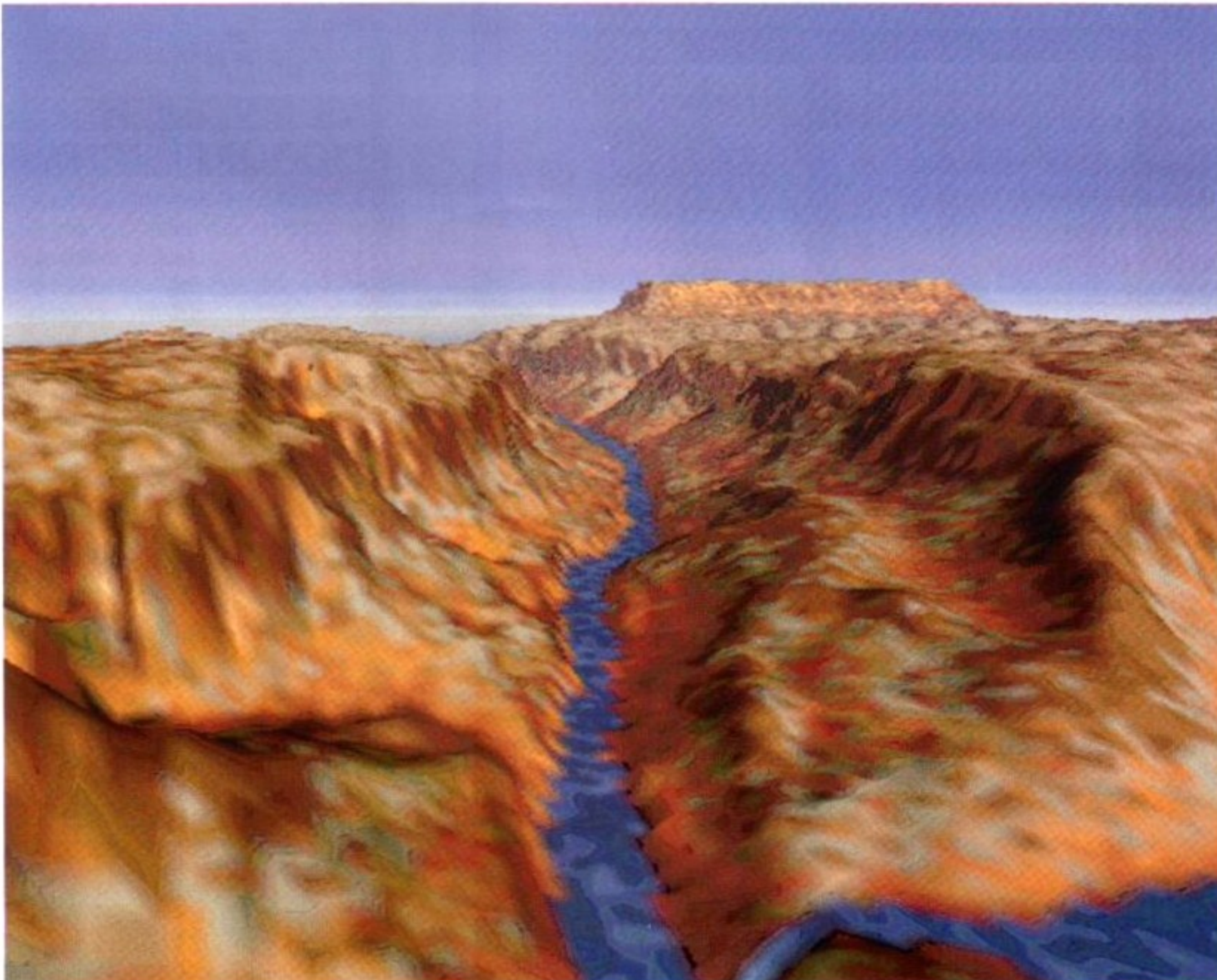

For a continuous loop of animation, repeat this task until you have a closed loop of target and camera points. Now check that you have enough disk space (30-40K per frame will be needed for low res HAM) and click 'Script, Execute'. For a 10-second anim at 10 frames per second in low-res HAM you need about 4Mb of disk space and between 60 and 70 hours on a non-accelerated Amiga. We set ours up on Friday night and let it run...

The package also includes a proprietary animation player called VANIM which allows you to view your creations at up to 13 frames per second. To use it all you have to do is enter the CLI and type:

```
Viewer <name of the animation>
```

The animation will automatically load and run - the frame rate can be controlled from the numeric keys on the keyboard while the keypad acts as a fast forward/rewind system.

*VistaPro* is instantly enthralling. Visitors to the *Amiga Format* office have found the sight of half the team crowded round a monitor puzzling, to say the least. But the expectation of another new landscape coming into view is so strong that after a few hours you even begin to believe the 'California-speak' in the manual - "*VistaPro* will free humanity from its current boundaries..." There's a strong compulsion to see what the landscape looks like from over there, or higher or at night, or at sunset...

Using the fractal landscape generator you can also create landscapes based on particular numbers such as dates of birth. In all it's a fascinating program that delivers high-quality results and a lot of fun combined with a good deal of educational value

The only other program on the market that really compares to *VistaPro* is its predecessor *Vista*. Even between such close relatives there really is no comparison: *VistaPro* is faster, more heavily-featured and produces results of a vastly improved quality. At £80 it's not a cheap program, but the polished interface is a joy to use and the quality of the results it produces speak for themselves.

Add to this an almost overwhelming degree of control and an animation engine that is child's play to use and there you have it - *VistaPro* is most definitely a winner. 

## VistaPro

**SPEED** ●●

Er, slow. But then at top resolution each image contains 130,000 polygons in full 24-bit colour...

**DOCUMENTATION** ●●●●

An excellent manual that tells you all you need to know about landscape generation.

**ACCESSIBILITY** ●●●●●

Load the program, load a landscape, click render. It's that easy to get going.

**FEATURES** ●●●●●

Sub-menus and dialogs give incredible control over every conceivable aspect of rendering.

**VALUE** ●●●●

At £80 it's not cheap but the results speak for themselves. Have patience and enjoy!



90%

Choose from one of the 3 packs below, but hurry, stocks VERY limited.

HEROES PACK	ARTISTS PACK	BEGINNERS PACK
★ A500 Computer .....RRP £399.95	★ A500 Computer .....RRP £399.95	★ A500 Computer .....RRP £399.95
★ Robocop.....RRP £24.95	★ Spritz Paint .....RRP £49.95	★ Wicked 9 Game Pack.....RRP £24.95 (9 basic games to get you going)
★ Batman The Movie .....RRP £24.95	Super Paint Package	★ Megablaster Joystick .....RRP £6.95
★ Ghostbusters II.....RRP £19.95		★ Quality Mousepad .....RRP £6.95
★ Indiana Jones .....RRP £19.95		★ Pack of ten disks.....RRP £9.95
TOTAL RRP £489.75	TOTAL RRP £449.90	TOTAL RRP £448.75
VALUE PACK PRICE <b>£310.99</b>	VALUE PACK PRICE <b>£310.99</b>	VALUE PACK PRICE <b>£310.99</b>

Want a 1 Meg machine?

Order any of the packs above and we will install an extra 512K Ram board for only £24.95 (£29.95 for clock version)

Prices quoted supercede those previously advertised.

★ NEW ★ AMIGA ADDED VALUE OUTFIT PACKS

All packs come with the Amiga Value Pack of your choice (choose from above)

MONO PRINTER PACK	COLOUR PRINTER PACK	STEREO COLOUR MONITOR PACK	PROFESSIONAL PACK
★ Amiga Value Pack (Your choice of 3)	★ Amiga Value Pack (Your choice of 3)	★ Amiga Value Pack (Your choice of 3)	★ Amiga Value Pack (Your choice of 3)
★ LC10 Mono	★ LC200	★ 1084S or Philips 8833II (Please state which)	★ 1084S or Philips 8833II (Please state which)
★ All connecting cables	★ All connecting cables	★ All connecting cables	★ LC200
			★ All connecting cables
ONLY <b>£439.99</b>	ONLY <b>£494.99</b>	ONLY <b>£539.99</b>	ONLY <b>£739.99</b>

DOWLING

ESSENTIAL COMPUTER ACCESSORY PACK 1

- ★ Competition Pro 5000 joystick .RRP £16.95
- ★ High quality solid perspex computer dustcover .....RRP £14.95
- ★ 20 3 1/2" DS/DD disks with labels .....RRP £19.95
- ★ 40 capacity lockable disk box ....RRP £9.95
- ★ 3 1/2" disk drive cleaner kit .....RRP £9.95

TOTAL RRP **£71.75**  
PACK PRICE **£29.95**

ESSENTIAL COMPUTER ACCESSORY PACK 2

- ★ Naksha high quality powermouse .....RRP £34.95
- ★ High quality 8mm mousepad.....RRP £8.95
- ★ High quality solid perspex computer dust cover .....RRP £14.95
- ★ Twin joystick/mouse extension leads .RRP £9.95

TOTAL RRP **£68.80**  
PACK PRICE **£29.95**

COMMODORE A501 SCOOP PURCHASE

- ★ Official 512K Ram upgrade for A500
- ★ Complete with battery backed clock
- ★ Enclosed in protective shielding
- ★ Only approved upgrade not invalidating warranty
- ★ Official Commodore 1 year guarantee

RRP £99.99 SCOOP PRICE **£44.99**  
ORDER WHILST STOCKS LAST!

PACK 1 AMIGA PERIPHERAL PACKS PACK 2

Megaboard Ram Expansion.....RRP <b>£49.95</b>	PC 880 3.5" disk drive .....RRP £89.95
40 capacity lockable disk box .....RRP <b>£9.95</b>	Megaboard Ram Expansion .....RRP £49.95
20 3.5" DS/DD disks with labels ...RRP <b>£19.95</b>	40 capacity lockable disk box.....RRP £9.95
	20 3.5" DS/DD disks with labels .....RRP £19.95
	3.5" disk drive cleaner kit.....RRP £9.95

TOTAL RRP **£79.85** .....PACK PRICE **£39.95** TOTAL RRP **£179.75** ...PACK PRICE **£99.95**

COMPUTERS

UNIT 3, FORGE CLOSE, LITTLE END ROAD, EATON SOCON, CAMBS

## FROM THE POWER HOUSE

1.5Mb A500 Ram expansion card.....	£79.00
Blitz with PC880 drive .....	£65.00
Blitz Turbo .....	£19.95
A500 anti-click board.....	£15.00
Power mouse.....	£14.95
Slimline hard disk 40Mb.....	£299.00
Amiga 2000 internal drive kit .....	£46.95
A500 internal floppy drive .....	£46.95

### AMIGA

#### 1/2 MEG UPGRADE BOARD

- ★ Uses latest 4 chip design
- ★ Memory on/off switch
- ★ Option of battery backed clock
- ★ Full 12 month guarantee
- ★ New super low price

**£24.95**

**Clock version £29.95**

### DISK DRIVE STARTER KIT

- ★ PC880 3.5" High Quality Disk Drive .....£89.99  
(Features anti-click, on/off, superslim design)
- ★ Ten 3.5" DS/DD disks with labels .....RRP £9.99
- ★ 40 Capacity lockable disk box .....RRP £9.99
- ★ 3.5" Disk drive cleaner kit.....RRP £9.99

**TOTAL RRP £119.96**

**Starter Kit Price £59.99**

## STAR PRINTERS

LC10 Mono 9 Pin Dot Matrix 144/34cps.....	£149.95
LC200 Colour 9 Pin, 180/45 cps, 16K Buffer .....	£199.95
LC24-200 Mono 24 Pin Dot Matrix, 200/67cps.....	£239.95
LC24-200 Colour 24 Pin, 200/67 cps, 30K Buffer .....	£289.95

### PRINTER ACCESSORY PACK

Only available when purchased with a printer.

- ★ Parallel printer cable - RRP £14.95
- ★ 200 sheets listing paper - RRP £6.95
- ★ Quality tailored dust cover - RRP £12.95

**TOTAL RRP £34.85**

## PRICES

**SMASHED**

	RRP	OUR PRICE
Music X V1.1	£149.95	£69.95
Music X Junior	£79.95	£39.95
Midi Interface (In-thru-out-out) with lead	£29.95	£17.99

**PACK PRICE £9.95**

**with printer stand**

**£14.95**

## ESSENTIAL ACCESSORIES

### Disks

Pack of 10 high quality 3.5" DS/DD.....	£4.99
Box of 10 branded TDK 3.5" DS/DD.....	£7.99
Box of 50 3.5" DS/DD with labels.....	£18.99
Box of 100 3.5" DS/DD with labels.....	£35.99
Box of 250 3.5" DS/DD with labels.....	£79.99
3.5" disk drive cleaning kit.....	£3.99

### Disk Boxes

3.5" 10 capacity Ryford box .....	£1.49
3.5" 40 capacity lockable box.....	£4.95
3.5" 80 capacity lockable box.....	£6.95
3.5" 80 capacity Van 3 (slim design).....	£7.95

### Mouse

8mm high quality mousepad .....	£3.99
Mouse/joystick extension leads.....	£5.99

### Dustcovers

PVC quality covers for computer/printer.....	£6.99
High quality solid Perspex dustcover .....	£9.99

## MICROSWITCH JOYSTICKS

*The only joysticks worth buying,  
full 1 year guarantee!*

### QUICKJOY III SUPERCHARGER

Two fire buttons, Auto-fire,  
Six micro-switches.....£8.99

### QUICKSHOT TURBO

Two fire buttons, Auto-fire, six micro-switches...£9.99

### QUICKJOY VI JETFIGHTER

Two fire buttons, Autofire with fast/slow mode,  
6 m/s.....£12.99

### COMPETITION PRO 5000

Two fire buttons, steel shaft, Autofire, m/s....£12.99

### ZIPSTICK AUTOFIRE

Two fire buttons, steel shaft, Autofire, m/s....£13.99

### STINGRAY AUTOFIRE

Direct replacement for Konix Navigator.....£14.99

### QUICKJOY V SUPERBOARD

Six fire buttons, Autofire, stopwatch,  
Ten m/s.....£16.99

### QUICKJOY TOPSTAR - Highly recommended

Two fire buttons, A/f slow motion, 6 m/s,  
see through body.....£19.99

### QUICKJOY MEGABOARD

Four fire buttons, 8 m/s, A/f slow motion,  
stop watch, countdown.....£23.99



## HOW TO ORDER



### BY PHONE



Simply call our head office quoting your Access/Visa number on

**Mon-Fri 0480 403222**

**Sat 0480 403304**

By personally calling at  
our St Neots or Hertford Shop



### ST NEOTS

6 Priory Mall,  
St Neots, Cambs  
Tel: 0480  
403304

### HERTFORD

49 Railway St.  
Warren Place  
Hertford, Herts.  
Tel: 0992 554469



### BY POST

Make cheques, building society drafts or postal orders payable to:

**Dowling Computers**



### DELIVERY (UK Mainland, most areas)

Please add £6 courier delivery for orders over £100, add £2 p&p for orders under.

★ ★ ★ ★ ★ ★ ★ ★ ★ ★ ★ ★ ★ ★ ★ ★

## GOLD CLUB SERVICE

- ★ 7 day money back guarantee if not completely satisfied
- ★ 30 day exchange for new policy should a fault occur
- ★ 1 year guarantee giving FREE collection and delivery service should a fault occur
- ★ Exclusive gold card with personal membership number entitling you to special offers
- ★ All this for a nominal £10 per item over £100

### ★NEW★ PLATINUM CARD SERVICE ★NEW★

★ All the benefits of the successful gold card service (above) plus the following

- Extended 2 year guarantee from date of purchase. (*Peace of mind for 2 years*)
- Free use of loan machine should yours need to be repaired. (*Now you never need be without your expensive purchase*)
- Free collection and delivery service for the full two years should a fault occur. (*Just make one simple phone call and leave the rest to us!*)
- Exclusive platinum privileged customer card entitling you to special offers.
- All of these benefits for the incredible price of just £39.95 per item purchased.

*N.B. In the unlikely case of shortages of identical model loan machines a suitable alternative will be offered.*

## WHY CHOOSE DOWLING?

- ★ **ESTABLISHED OVER 5 YEARS**  
With a growing reputation for "putting the customer first". We intend to satisfy many more customers for years to come
- ★ **TECHNICAL SUPPORT/ON-SITE ENGINEERS**  
Employing over 20 specialist staff, we are equipped to deal with the majority of queries
- ★ **FULL TESTING PROCEDURE**  
All computer hardware is tested prior to despatch, proving Dowlings commitment to customer care

*So choose Dowling and put  
our reputation to the test!*

**TELESALES ORDER LINE (MON-FRI) 0480 403222/(SAT) 0480 403304**

**COMMODORE  
1084S STEREO  
MONITOR**

Including FREE lead  
**ONLY £229.00**

**PHILIPS 8833 MK II  
STEREO MONITOR**

Including Free Lead  
**ONLY £229.00**

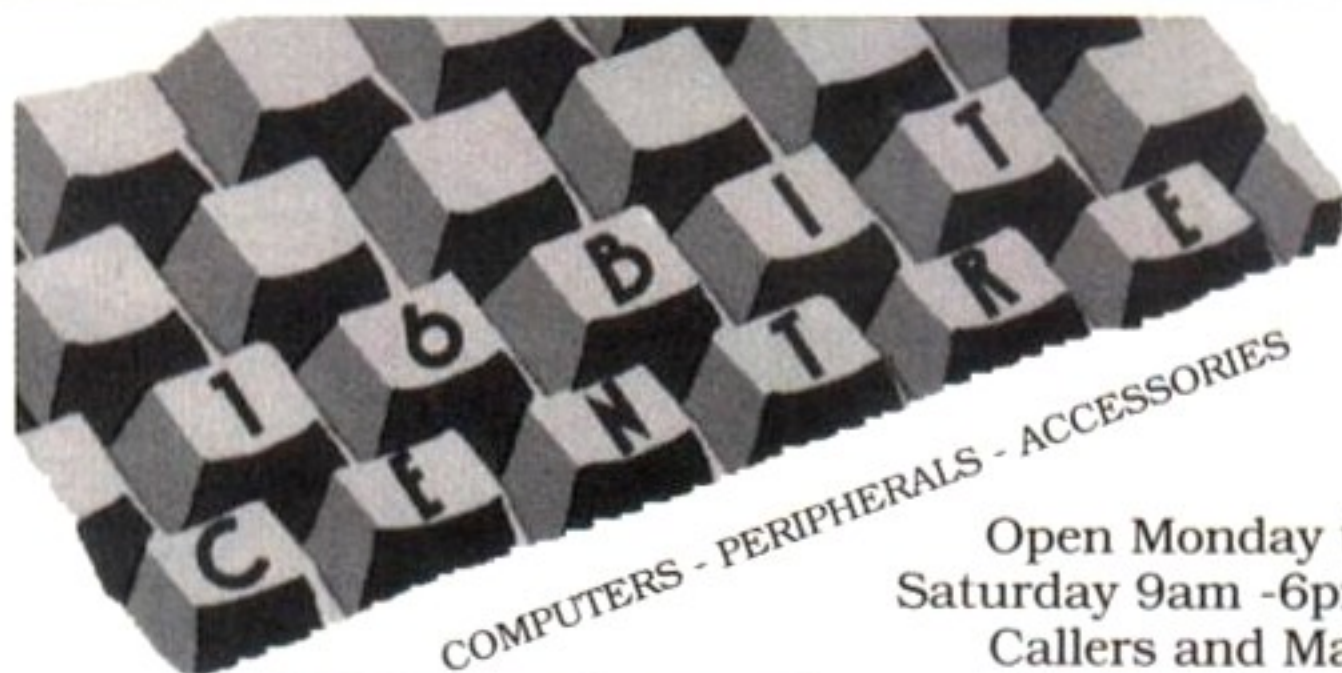

COMPUTERS - PERIPHERALS - ACCESSORIES

**CDTV now in stock**

Open Monday to  
Saturday 9am -6pm  
Callers and Mail  
Order welcome

**BATTLE OF  
BRITAIN  
THEIR FINEST  
HOUR  
ONLY £20.00**

**AT ONCE AMIGA**

PC 286 AT EMULATOR  
FOR THE A500  
**ONLY £175.00**

**AMIGA PACKS**

SCREEN GEMS PACK, inc. Shadow / Beast II, Back/Future II, Nightbreed, Days of Thunder, Dpaint II .....	£359.00
AMIGA A500, mouse, modulator, power supply, Workbench 1.3, Basic Tutorial and manuals .....	£309.00
CARTOON CLASSICS inc: 1Mb Ram, Lemmings, Simpsons, Captain Planet, Deluxe Paint 3 .....	£369.00
CLASS OF THE 90'S FIRST STEPS, inc. Extra 512K, Pr-Write, Info File, Dpaint + Dprint II etc .....	£515.00
CLASS OF THE 90'S, inc. Extra 512K, Publishers Choice, MaxiPlan, BBC Emulator, Midi Int. etc .....	£515.00
AMIGA CREATIVITY PACK, with Word Processor, Music & Paint packages, 3 games + Tutorial Video .....	£419.00

All Amiga A500's supplied with mouse, modulator, manuals, workbench, Basic + Tutorial

**AMIGA A500 FUN PACK**

Amiga A500, Mouse, Modulator, Manuals, Basic, Workbench, Tutorial, Joystick, Disk Box, 10 Blank Disks, Dust Cover, Dpaint II, PLUS 14 GREAT GAMES Shadow of the Beast II, Back to the Future II, Nightbreed, Days of Thunder, Star Wars, Toobin, Barbarian II, Licence to Kill - James Bond Game, Running Man - With Schwarzenegger, APB, Xybots, Dragon Spirit, Hard Drivin, Voyager

**STILL ONLY £399.00 1 Meg version £429.00**

**AMIGA A500 MAX PACK**

Amiga A500, Mouse, Modulator, Manuals, Basic, Workbench, Tutorial, Joystick, Disk Box, 10 Blank Disks, Dust Cover, Dpaint II, PLUS 10 GREAT GAMES Star Wars, Toobin, Barbarian II, Licence to Kill - James Bond Game, Running Man - With Schwarzenegger, APB, Xybots, Dragon Spirit, Hard Drivin, Voyager

**ONLY £359.00 1 MEG VERSION £389.00**

**SOFTWARE AND DISKS**

3D PROFESSIONAL .....	£209.00	PIXEL 3D .....	£49.00
AMOS + EXTRAS DISK .....	£32.00	PRO VIDEO POST .....	£159.00
BROADCAST TITLER II .....	£169.00	PRO-WRITE V3.1 .....	£85.00
CAN DO Authoring Software .....	£79.00	SCULPT ANIMATE 4D .....	£225.00
DIGIVIEW GOLD V4 .....	£95.00	TITLE PAGE .....	£109.00
LATTICE C V5.1 .....	£149.00	PROFESSIONAL PAGE V2 .....	£169.00
PAGESETTER V2, DTP .....	£47.00	VIDEO EFFECTS 3D .....	£109.00
PAGESTREAM, New Version 2.1 .....	£139.00	X-CAD DESIGNER (1 Meg) .....	£69.00
PAGESTREAM FONTS .....	£22.00	X-CAD PROFESSIONAL .....	£129.00
TV TEXT PROFESSIONAL .....	£79.00	WORDWORTH .....	£99.00
CROSS-DOS, Multi-format file transfer .....	£23.00		
PANASONIC 1410/4 VIDEO CAMERA. Ideal for DigiView .....	£159.00		
PEN PAL, Excellent Word Processor (1 Meg) .....	£69.00		
IMAGINE 3D Animation & Rendering software .....	£179.00		
DIGI-PAINT III. Full featured HAM package .....	49.00		
ALL IN ONE, Art package, Word Pro + Music package .....	£119.00		
TV SHOW, Video wipes, titling package .....	£55.00		
PHOTON PAINT II, HAM Art + Animation .....	£25.00		
AMOS COMPILER .....	£26.00		
THE WORKS PLATINUM. Integrated package .....	£62.00		
AMIGA VISION. Authoring software .....	£89.00		
DOS 2 DOS Multi-format file transfer .....	£33.00		
WALT DISNEY ANIMATION STUDIO (1 Meg) .....	£69.00		
SPECTRA COLOUR .....	£55.00		
X-UTILITIES .....	£34.00		

**HARDWARE**

COMMODORE A590 20MB Hard Disk, Unpopulated .....	£285.00
COMMODORE A590 20mb Hard Disk + 2m RAM .....	£347.00
FRAME GRABBER PAL .....	£449.00
RENDALE 8802 Genlock, A500/B2000 .....	£185.00
AUDIO ENGINEER Sampling hardware/software .....	£169.00
SOPHUS S5 Professional Stereo Sampler .....	£49.00
KCS POWERBOARD, PC Emulation (A500) with MS DOS .....	£219.00
AMIGA compatible external disk drive, switch plus thru port .....	£57.50
GVP 52MB SCSI hard drive & 8M RAM Board for A500 .....	£499.00
GVP 48 MEG SCSI Drive plus 8 Meg Ramboard for 1500/2000 .....	£419.00
GOLDEN IMAGE HAND SCANNER with software plus Photon Paint .....	£179.00
NAKSHA CLONE MOUSE .....	£19.95

**PRINTERS**

STAR LC-10 MONO PRINTER inc. Lead .....	£159.00
STAR LC-200 COLOUR PRINTER inc. Lead .....	£209.00
STAR LC-24/200 MONO PRINTER inc. Lead .....	£249.00
STAR LC-24/200 COLOUR PRINTER inc. Lead .....	£297.00
CITIZEN SWIFT 24 MONO inc. Lead .....	£279.00
CITIZEN SWIFT 24 COLOUR inc. Lead .....	£275.00
CITIZEN 124D 24 Pin Mono inc. Lead .....	£195.00
CITIZEN 120D Plus, 9 Pin Mono inc. Lead .....	£139.00
CITIZEN SWIFT 9 COLOUR inc. Lead .....	£179.00
CANON BJ10E bubble jet inc. Lead .....	£269.00

**AMIGA A1500**

The NEW A1500 inc. Stereo Monitor, Twin Drive, Dpaint3, The Works Plat., +4 Games, **ONLY £889.00**

AMIGA A500 part exchange available - please phone

**AMIGA MEMORY**

SUPRA 8M Board for A500 inc 1M .....	£125.00
B2000 Microbotics 8M Ram Board + 2 Meg RAM .....	£159.00
Extra 2 Meg Ram for above board .....	£75.00
A500 TARGET 512K Ram, With Clock + Switch .....	£36.00

**SUPRA/BAUD BANDIT 2400 MODEM**

Hayes Compat. Auto-dial/answer, V21, 22, 22bis **£124.00** Supra 2400 Plus, MNP5 + V42 Bis (speeds up to 9600) **£189.00**  
As above but includes MNP5 error correction **£159.00**. New Supra 9600 Modem (speeds up to 38000) **£399.00**

**HOW TO ORDER:**  
Either call our number below with your credit card details, or send a cheque/PO or credit card number and expiry date to our address. Make cheques payable to **THE 16 BIT CENTRE**  
Prices subject to change without notification.

**All prices include VAT + Courier Service**

**16 BIT CENTRE**

Units 15-17,  
**Lancashire Fittings Science Village**  
**Claro Road, Harrogate HG1 4AF**

**Tel (0423) 531822/526322**

**EXTENDED WARRANTY  
AND MAINTENANCE  
CONTRACTS AVAILABLE  
ON ALL ITEMS. PLEASE  
CALL FOR FURTHER  
DETAILS**

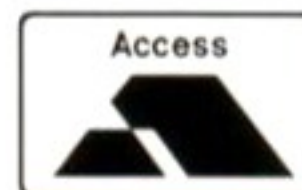



# NO ONE TAKES A GAME APART LIKE

**BRITAIN'S  
BEST-SELLING  
AMIGA GAMES  
MAGAZINE!**

# AMIGA POWER

## FIRST COMES THE REVIEW...

AMIGA POWER reviews more Amiga games than any other magazine! At least 40 new full price, budget and PD – plus almost 300 older games – rated every month!

AMIGA POWER gives them more space too – up to four (or more!) pages for the games that really deserve it!

Giant maps take you through every level of the game.

100 percent colour! There isn't a single black and white page in AMIGA POWER, and that includes every last game review!

Giant linked screen grabs show you exactly what the game looks like overall.



The Bottom Line – quite simply, the clearest, toughest scoring system yet devised.

Big name reviewers, including Matt Bielby, Colin Campbell and Gary Penn.

All is revealed – from each baddy's hit points to how much you'll earn if you kill him...

...while boxes, panels and annotated screens explain all the details.

Large size paper (the same as this new look Amiga Format) gives games more room to breathe!

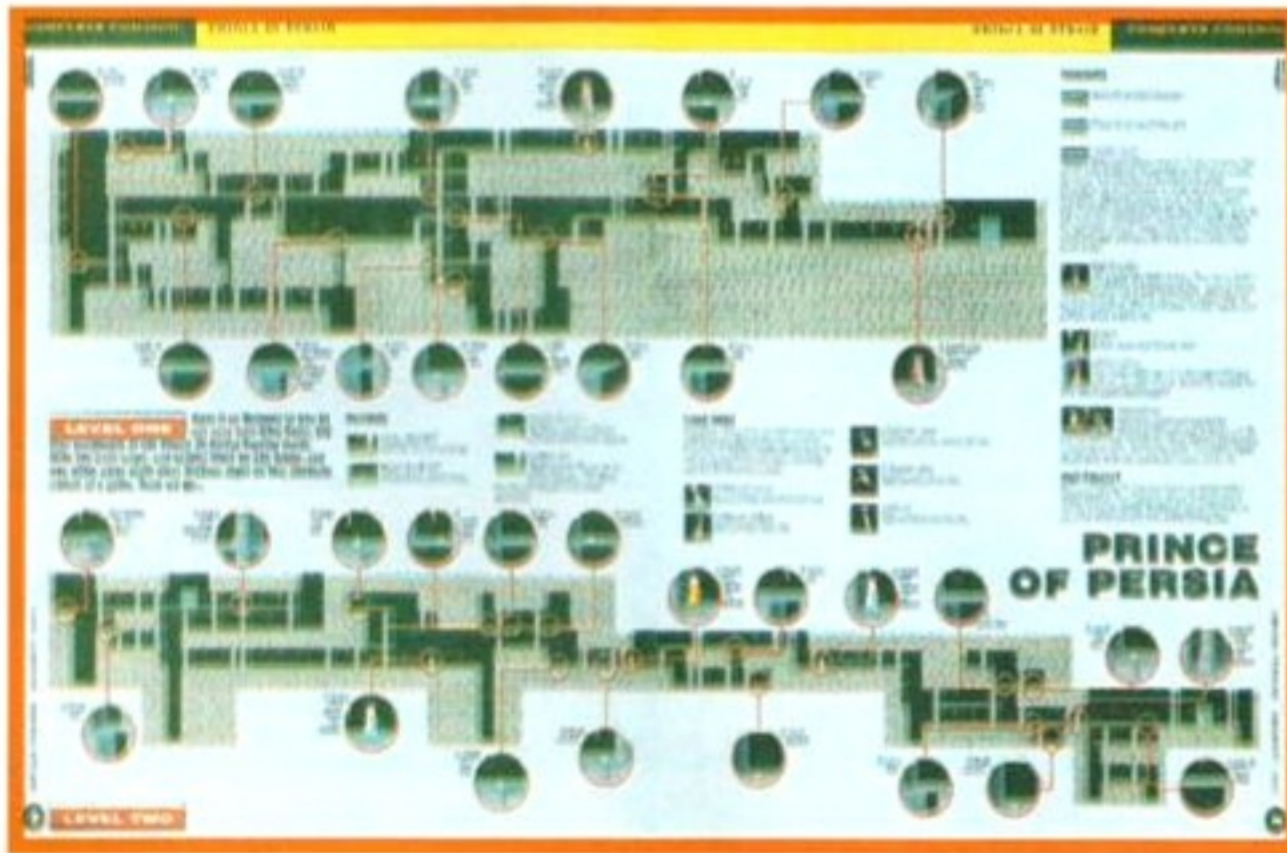

## ...AND THEN THE TIPS

- AMIGA POWER carries more pages of tips per issue than any other Amiga magazine (or any other games magazine at all, for that matter).
- Giant maps take you through every last screen of the game – some of our complete player's guides have run to well over ten pages!
- Every object, every trap and every enemy revealed.
- And, of course, all our hero's abilities made crystal clear.

## NOT TO MENTION...

- THE AMIGA POWER COVERDISK brings you the greatest demos and the best PD games every month.
- The AMIGA POWER team have quickly earned a reputation as the toughest reviewers in the business. If we say a game's good, you can be sure it will be – because we don't say it very often!
- PLUS! The most EXTENSIVE news coverage, the BEST competitions, the MOST IMAGINATIVE covermounts, and more interviews with the people BEHIND the top games than any other magazine.

## If you're into Amiga games you should be into AMIGA POWER

August issue out now  
September issue out  
August 28th  
**ONLY £2.95**

# UNIVERSAL OVERNIGHT DISTRIBUTION LTD

If you need cheapo "no name" disks & cut throat prices, please ignore this advert

Tel: 0228 512131 (24 hour order line) • Personal Callers Welcome • Fax: 514484  
Unit 26, Enterprise Centre, James Street, Carlisle, Cumbria, CA2 5BB

## HIGH SPECIFICATION 3.5" DISKS

	Our Brand	KAO
50 DSDD.....	44p each.....	49p
100 DSDD.....	40p each.....	44p
250 DSDD.....	35p each.....	41p
500 DSDD.....	34p each.....	38p

Individually wrapped, 100% certified and guaranteed 3.5" DSDD 135tpi disks with labels.



## DISK BOXES

Lockable high quality disk boxes at unbeatable prices:

Qty:	1+	3+	6+
50 cap	£5.99	£5.25	£4.99
100 cap	£6.99	£6.25	£5.99

12 capacity library cases...Five for £5.75

## 3.5" DISKS WITH BOXES

25 Disks with locking disk box.....	£17.95
35 Disks with locking disk box.....	£22.95
45 Disks with locking disk box.....	£26.95
55 Disks with locking disk box.....	£31.95
80 Disks with locking disk box.....	£39.95
160 Disks with locking disk box.....	£71.95
240 Disks with locking disk box.....	£122.95

All Universal brand disks exceed ANSI standards, contain free labels and are probably the best buy on the market.

Individually wrapped 100% guaranteed DSDD disks  
**Remember - Prices INCLUDE VAT AND POSTAGE**



## DUST COVERS

Amiga and Atari Dust covers. High quality covers protect your Amiga or Atari keyboard

1+	3+	6+
£3.75	£3.25	£2.99

**QUALITY COMES FIRST AT UNIVERSAL!**



## ACCESSORIES

Mouse Mat: .....	£2.99
Mouse House:.....	£1.99
3.5" Cleaning Kit:.....	£2.95
5.25" Cleaning Kit:.....	£2.95
IBM or AMIGA parallel printer cable:.....	£7.95
Universal plastic printer stands.....	£6.95
Extra disk labels (3.5") per 100 .....	£1.50

**DON'T RISK STORING DATA ON OTHER TYPES OF DISKS - OURS ARE INDIVIDUALLY WRAPPED, 100% CERTIFIED AND GUARANTEED ERROR FREE**

**OUR DISKS ARE PROBABLY THE BEST IN THE WORLD, MANUFACTURED BY SONY, MITSUBISHI ETC. DON'T USE ANY OTHER DISK**



## MONITOR STAND

The monitor stand enables you to swivel your monitor in nearly any direction.

**1+ £14.50 - unbeatable**

High quality 14" Universal monitor stand takes any monitor from 12" to 16"

## MEGA COMPETITION

You could win a £50 mail order voucher!!

**Call (0898) 886200 NOW**

Calls charged at 34p per minute cheap rate/45p per minute all other times.

**ALL PRICES INCLUDE VAT AND POSTAGE!!**



To order via telephone simply quote credit card number and expiry date

To order via mail make cheque or PO payable to:

**UNIVERSAL OVERNIGHT DISTRIBUTION LTD**

**VISA**

Trade customers, call for spot prices. Bulk buyers - we have great prices.

Overnight courier (get your goods tomorrow!) **£7.99**. Minimum order value: £10 on all orders

**BACK IN ISSUE 17**, we reviewed a sampler by the name of TechnoSound. Despite the relatively cheap asking price and simplified functions, the package marked a new market for 'entry level' samplers – a system whereby even novices to Amiga music could start to experiment with sounds and tunes.

These days advances in technology wait for no man, so after eight months on the market it's well worth updating established systems. This is exactly what New Dimensions have done by releasing a new version of their package under the name TechnoSound Turbo.

The hardware is unchanged and the basic form of the software is the same as the original, in that most of the functions are based around the same interface system. The controls are laid out in pretty much the same way, with the main play, record, zoom and mode controls being placed in their own positions on screen.

The extra functions, such as editing, looping, disk control and real-time effects, are called up by clicking on buttons to the right of the screen. Each button will make a different strip appear at the bottom of the screen, containing a series of controls which can be used in combination with those on the main screen.

**Recording a sound** is pretty simple. Just start your input to the sampler, adjust the level until the input scope display doesn't overload and press the Record button. The program will then monitor the input until you hit the left mouse button to start sampling.

Actually editing a sound is a much more complex affair. The only way to zoom in on a particular piece of a waveform is to move the start and end pointers, which also control the loop. This sounds easy enough, but the fact that you have to use the left and right buttons to move the start and end pointers respectively and that there is only a two-level zoom makes editing a far from fluid process. Also, a niggle from the original TechnoSound is still present. There is only a 50K edit buffer! This means that you can only snip away pieces of your waveform a little bit at a time, which is hardly conducive to intuitive sample editing!

**The most significant addition** in the Turbo version is the sequencer. This comes in two forms – the first is a simple sample sequencer which allows you to string sounds together to form rhythm patterns. The second editor is MIDI-based, allowing you to set up full MIDI compatible tunes.

Unfortunately, the full potential of this system hasn't really been realised. The editing screens for both sequencers take up about an eighth of the total screen, with small, fiddly controls which aren't obviously marked.

If you really want to include samples into your own tunes, you'd be better off going for a dedicated entry-level sequencer, such as Aegis' *Sonix*, rather than struggling with this rather simplistic system.

**TechnoSound's major strength** is that it is a no-nonsense, low-cost, easy-to-use system aimed at beginners to the world of sampling. Unlike other entry-level systems, the sound quality manages to measure up favourably

This entry-level sampler may be cheap, but in our round-up four months ago the hardware came out very well. Now the software's been updated to add a sequencer, so you can make samples into songs. **Maff Evans** cops an earful and passes judgement.

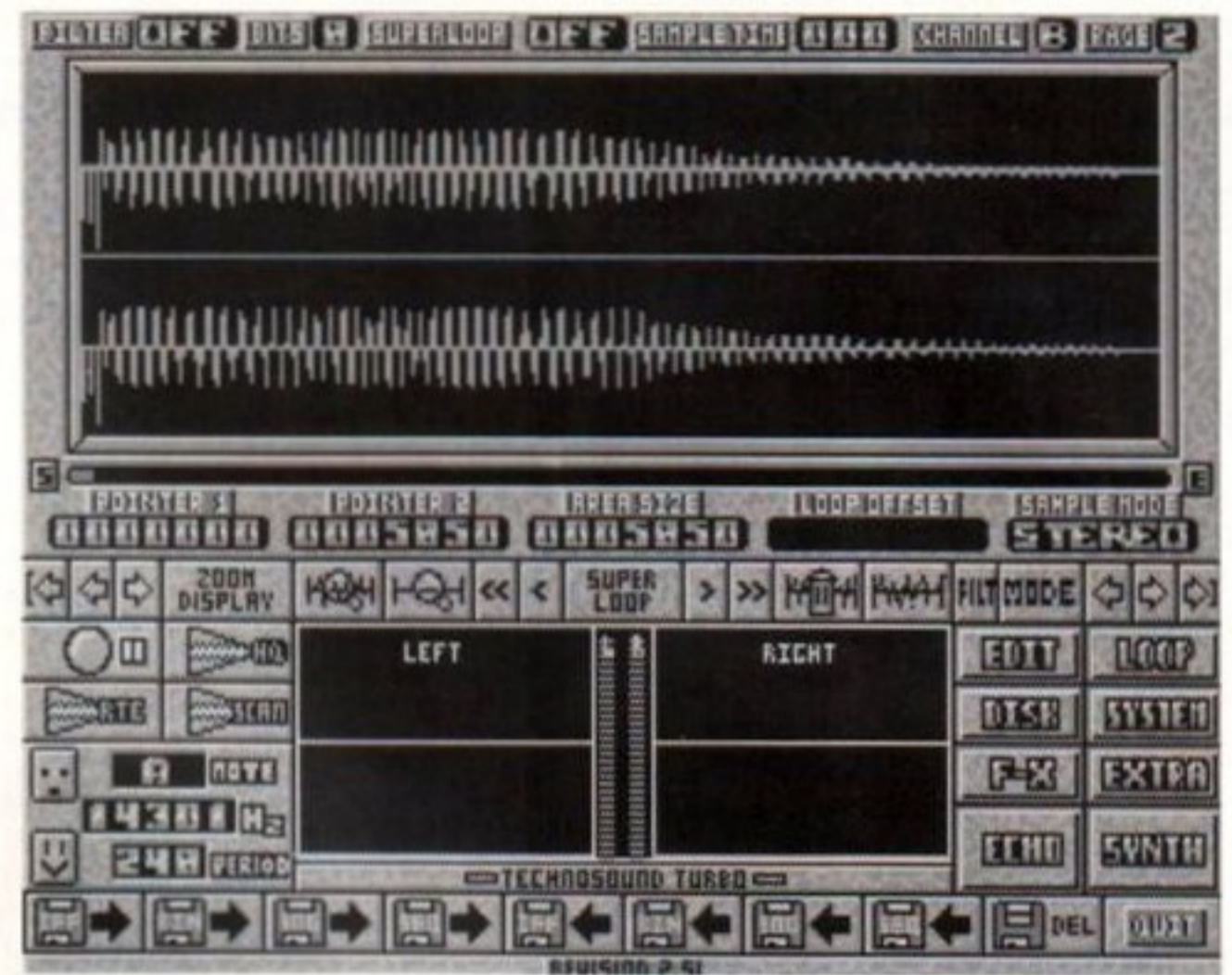

Anyone who already has TechnoSound might not be able to spot much of a difference in the Turbo version. In actual fact nothing has changed in the main program, the additions being sequencing and effects from new buttons.

# TechnoSound Turbo

Sound sampling package ■ £35.99 ■ New Dimensions

**EXTENDED REMIX** - *TechnoSound Turbo* offers a number of refinements and additions over the original version to bring the package up to date.

**PLAY TYPES** - Instead of simply having the option to play a sound, you can now scan the waveform as it is played, play back in HiFi mode with a blank screen or play at the default sound rate.

**REALTIME ECHO** - A series of new echo settings has been included, along with the ability to program your own echo set-ups in full stereo.

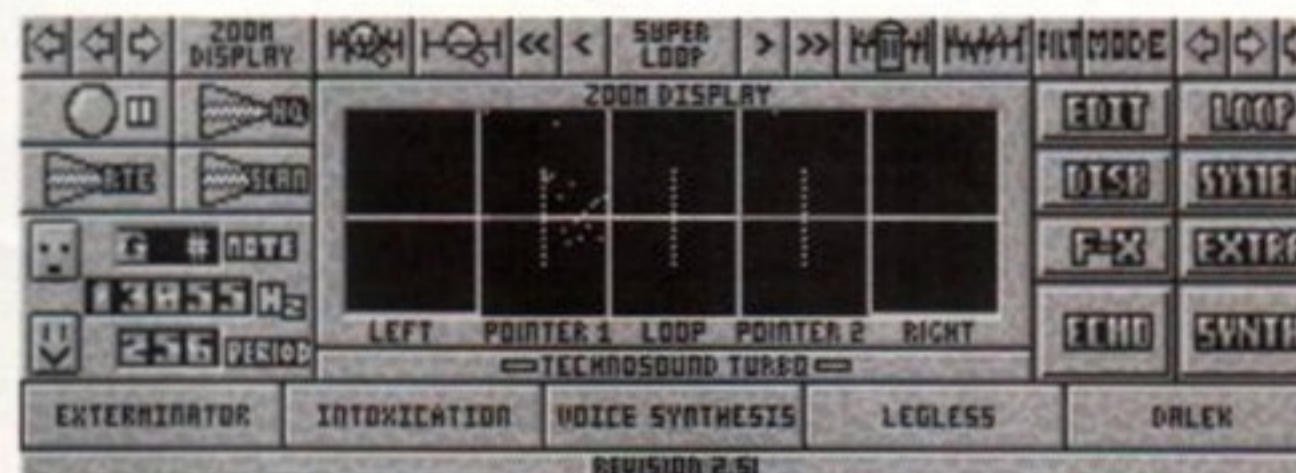

**VOICE SYNTH EFFECTS** - As well as echo and phasing effects, you can also use a series of strange vocaliser effects including pitch-shifting and 'Dalek' effects.

**MULTITASKING** - You can now load *TechnoSound* via the CLI and access Workbench from the main program.



**SEQUENCING** - Samples can be constructed into rhythm patterns or a full-blown MIDI sequence written within the sampling program itself.

with many more advanced and more expensive systems. TechnoSound Turbo continues the tradition of a low-cost, entry-level sampler and boosts the package by adding some very nice real-time effect options.

Unfortunately this is the only real improvement over the original system – the sequencers do not cut it – and established users may not think it worthwhile to pay another £6 just for a few new effects.

But if you are new to the world of sampling the package is still an extremely good place to start, particularly with the new additions. If you're thinking about updating to the new system, then I suggest that you try the new version out before you buy: but then again, £6 isn't a great deal to pay for an effects unit in this day and age!

Technosound Turbo  
£35.99 New Dimensions 0291 690933

## Technosound Turbo

<b>SPEED</b>	● ● ●
Mostly pretty good, but some options, such as disk commands, seem to take an age.	
<b>DOCUMENTATION</b>	● ● ●
Good tutorials and manual, but a few example tunes on the disk would make things clearer.	
<b>ACCESSIBILITY</b>	● ● ● ●
Pretty straightforward, but some options are rather fiddly to use. The manual does help.	
<b>FEATURES</b>	● ● ●
Pretty ropy editing and sequencing functions, but the real-time effects are excellent.	
<b>VALUE</b>	● ● ● ●
A cheap system, for the price it offers novices a good springboard into Amiga music.	

**Verdict** **81%**

# K.G. Leisure.....

..... we make it easy for you! .....

All prices include VAT. All orders sent by 1st class post

Telephone Orders/Enquiries

0443 862127

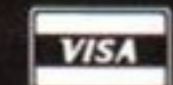

Mon-Sat



9am-7pm

## The Games Room

Games Marked ★ = New release: sent when available	
3D Construction set.....	£31.99
3D Pool.....	£7.99
3 Stooges (Budget).....	£7.99
4D Boxing.....	£20.49
A10 Tank Killer.....	£23.99
Advanced Destroyer Simulator.....	£16.99
Amiga Encounter.....	£17.49
AMOS (Games Creator).....	£34.99
APB (Budget).....	£6.99
★ Aracnophobia.....	£17.49
Arkanoid.....	£5.99
Arkanoid 2 (Revenge of Doh) Budget.....	£6.99
Armalyte.....	£17.49
Armour Geddon.....	£16.99
Atomino.....	£17.49
Barbarian-Ultimate Warrior (Budget).....	£7.99
Bards Tale 3.....	£16.99
Bards Tale 2 (Budget).....	£7.99
BAT.....	£19.99
★ Battlebound.....	£16.99
Battle Chess.....	£17.49
★ Battle Chess II.....	£17.49
★ Beast Busters.....	£17.49
Bill & Ted's Exc. Adventure.....	£17.49
Billiards II.....	£17.49
Bionic Commando (Budget).....	£7.99
★ Blade Warrior.....	£17.49
Brat.....	£17.49
Cadaver.....	£17.49
Cadaver Levels.....	£11.99
Cadaver-The Pay Off.....	£16.99
Cardinal of the Kremlin.....	£17.49
Carrier Command (Budget).....	£7.99
Centurion.....	£17.49
Challenge Golf.....	£16.99
Champion of the Raj.....	£16.99
Chaos Strikes Back (1Meg).....	£17.49
Charge of the Light Brigade.....	£20.49
Chuck Rock.....	£16.99
Cohort Fighting For Rome.....	£19.99
Coin Op Hits 2.....	£20.49
Colossus Chess.....	£17.49
Conflict - Europe (Budget).....	£7.99
Cricket Captain.....	£17.49
Cricket Simulator (1Meg).....	£19.99
★ Crimewave.....	£17.49
Crime Doesn't Pay.....	£17.49
Crystals of Arborea.....	£16.99
Cybercon 3.....	£17.49
Damocles Compendium.....	£17.49
Das Boot.....	£19.99
Defender Of The Crown (Budget).....	£7.99
Demoniak (1Meg).....	£20.49
★ Deuterios.....	£16.99
★ Double Double Bill.....	£24.49
Dragons Spirit (Budget).....	£6.99
Dungeon Master (1Meg).....	£17.49
Elite.....	£17.49
Elvira (1Meg).....	£20.49
Emlyn Hughes Soccer.....	£17.49
Enchanter (Budget).....	£8.49
England Championship Special.....	£17.49
★ Escape From Colditz.....	£20.49
European Superleague.....	£16.99
Eye Of The Beholder.....	£19.99
F15-Strike Eagle II.....	£23.99
F19 Stealth Fighter.....	£20.49
F29 Retaliator.....	£17.49
Fantasy World Dizzy (Budget).....	£6.99
Ferrari Formula 1 (Budget).....	£8.99
Fists of Fury (Compilation).....	£17.49
★ Flight of the Intruder.....	£20.49
Flight Simulator 2.....	£24.99
Football Director 2.....	£14.99
Forgotten Worlds (Budget).....	£6.99
★ Formula 1 (3D).....	£17.49
Frenetic.....	£17.49
Full Contact (Budget).....	£7.99
Future Wars.....	£17.49
Gauntlet 2 (Budget).....	£6.99
Gem-X.....	£16.99
Go.....	£17.49
GODS.....	£16.99
Golden Axe.....	£16.99
★ Grand Stand (Compilation).....	£20.49
Gunboat.....	£20.49
★ Halls of Montezuma.....	£17.49
Hard Drivin (Budget).....	£6.99
Heroes (Compilation).....	£20.49
Hero Quest.....	£16.99
Hill St.Blues.....	£16.99
Hollywood Collection (Compilation).....	£20.49
Hunter.....	£20.49
IK+ (Budget) (see Premier Collection).....	£6.99
Indianapolis 500.....	£16.99
★ International Championship Athletics.....	£17.49
International Ice Hockey.....	£17.49
I Play 3D Soccer.....	£16.99
Jack Nicklaus Golf.....	£17.49
Jack Nicklaus 91 Champ Course 5£10.99	
Jack Nicklaus Unlimited Golf (1Meg).....	£19.99
James Pond (1Meg).....	£17.49
Kick Off 2.....	£13.49
Kick Off 2 (1Meg).....	£16.49
Kick Off 2 Final Whistle.....	£8.99
Kick Off Winning Tactics.....	£6.99
Kick Off + Extra Time (Budget).....	£6.99
Killing Cloud.....	£16.99
Kult (Budget).....	£6.99
Leisure Suit Larry (Triple Pack).....	£34.99
Lemmings.....	£16.99
Leonardo (Budget).....	£6.99
Life and Death.....	£17.49
Little Puff (Budget).....	£6.99
★ Logical.....	Phone
Lombard RAC Rally (Budget).....	£6.99
Loom.....	£20.49
Lords of Chaos.....	£17.49
Lotus Esprit Turbo.....	£17.49
M1 Tank Platoon.....	£20.49
★ Magic Story Book.....	£20.49
Man. Utd - Europe Edition.....	£17.49
Mega Traveller.....	£20.49
Mercs.....	£17.49
Metal Mutant.....	£17.49
Miami Chase.....	£6.99
Monster Pack (Compilation).....	£17.49
Monty Python.....	£14.49
Moonbase.....	£23.99
MUDS.....	£17.49
Murder.....	£17.49
★ Myth.....	£17.99
NAM.....	£20.49
Navy Seals.....	£17.49
Ninja Remix.....	£16.99
Ninja Warrior.....	£14.49
North and South (Budget).....	£6.99
Oriental Games.....	£17.49
Panza Kick Boxing.....	£17.49
Passing Shot (Budget).....	£7.99
PGA Tour Golf.....	£17.49
Platinum (Compilation).....	£17.49
Player Manager.....	£14.49
Populous.....	£16.99
Populous Promised Lands.....	£8.99
Powermonger.....	£19.99
★ Powermonger Data Disk 1.....	£11.49
Power Up (Compilation).....	£20.49
PP Hammer & Pneumatic Weapon.....	£16.99
Precious Metal.....	£17.49
Predator 2.....	£16.99

....the largest room!....

Prehistorik.....	£17.49
Premier Collection (Compilation).....	£17.99
Prince of Persia.....	£17.49
Pro Boxing (Budget).....	£6.99
Pro Flight (Hi-Soft).....	£32.99
Pro Tennis Tour 2.....	£17.49
Radio Controlled Racer (Budget).....	£6.99
Railroad Tycoon.....	£24.99
Rainbow Islands (see Power Up).....	£16.99
RBI II Baseball.....	£20.49
Red Storm Rising.....	£17.49
Rick Dangerous 2.....	£17.49
Robocop 2.....	£17.49
★ R-Type 2.....	£17.49
Sci-Fi (Budget).....	£6.99
Search for the King.....	£20.49
Secret of Monkey Island.....	£17.49
Secret of Silver Blades (1Meg).....	£20.49
Shadow Dancer.....	£16.99
★ Shanghai II - Dragons Eye.....	£24.99
Shapes & Colours (Educational).....	£6.99
Sherman M4 (Budget).....	£6.99
Silkworm (Budget).....	£6.99
Sim City Architecture 1 (Future).....	£11.99
Sim City Architecture 2 (Ancient).....	£11.99
Sim City Terrain Editor.....	£10.99
Sim City & Populous.....	£19.99
★ Sinbad (Budget).....	£7.99
★ Skychase (Budget).....	£7.99
Sorcerer (Budget).....	£8.49
Space Quest 3.....	£26.99
Speedball 1 (Budget).....	£8.49
Speedball 2.....	£16.99
Spell Book (4-9 Years).....	£6.99
Spirit of Excalibur (1 Meg).....	£20.49
St Dragon.....	£17.49
Steve Davis World Snooker.....	£7.99
Stormball.....	£17.49
Strip Poker II + Data Disk 1.....	£6.99
Super Cars 2.....	£16.99
Super Monaco Grand Prix.....	£17.49
★ Swap.....	£17.49
Switchblade 2.....	£17.49
SWIV.....	£16.99
Table Tennis Simulator (Budget).....	£6.99
Team Suzuki.....	£17.49
Teenage Mutant Hero Turtles.....	£16.99
Tennis Cup (Budget).....	£6.99
Test Drive II (Compilation).....	£20.49
★ Thunder Jaws.....	£17.49
TOKI.....	£16.99
Toobin (Budget).....	£6.99
Toyota Celica GT Rally.....	£17.49
Treasure Island Dizzy (Budget).....	£4.99
Trivial Pursuit.....	£14.49
Turrican 2.....	£16.99
★ TV Sports (US) Football (Budget).....	£8.49
Ultima 5.....	£20.49
UMS 2.....	£20.49
★ Virtual Worlds (Compilation).....	£20.49
VIZ.....	£14.49
Wargames Construction Set.....	£20.49
Warlords.....	£16.99
Warzone.....	£14.99
Waterloo (Budget).....	£7.99
Wheels of Fire.....	£20.49
White Sharks.....	£16.99
Wings (1Meg).....	£20.49
Wizball (Budget).....	£6.99
Wonderland (1Meg).....	£20.49
★ Worlds at War.....	£16.99
★ Worldclass Cricket.....	£19.99
Worldclass Leaderboard (Budget).....	£6.99
Wrath of the Demon.....	£20.49
Wreckers.....	£17.49
Xenon 2 (Budget).....	£7.99
Xybots (Budget).....	£6.99
Z-Out.....	£14.49
★ Zone Warrior.....	£17.49
Zork 3 (Budget).....	£7.99

## The Study

....serious work going on in here!....

Argasm 68000.....	£49.99
Aztec C Professional.....	£109.99
Aztec C Developer.....	£159.99
Deluxe Music Const. Set.....	£49.99
Devpac V2.0.....	£44.99
Excellence V2.0.....	£119.99
Lattice C.....	£169.99
Professional Page V2.....	£179.99
Scribble (Platinum).....	£39.99

## The Library

....lots of books on the shelves!....

Advanced Amiga Basic.....	£15.99
Amiga Assembly Language Programming.....	£13.49
Amiga Basic Inside and Out.....	£17.99
Amiga C for Beginners.....	£17.49
Amiga C for Advanced Users.....	£29.99
Amiga Disk Drives inside + out.....	£25.99
Amiga DOS inside + out.....	£17.49
Amiga DOS Reference Guide.....	£13.99
Amiga For Beginners.....	£11.99
Amiga Graphics inside + out.....	£29.99
Amiga Hardware Ref. Manual.....	£23.99
Amiga Machine Language.....	£13.99
ROM Kernal (Includes + AutoDocs).....	£29.99
ROM Kernal (Ref Libs + Devices).....	£29.99
Amiga System Programmers Guide.....	£29.99
The C Programming Language (2nd Edition) (Kernigan/Ritchie) *Excellent*.....	£24.99

## The Office

....useful programs for busy people!....

Cashbook Controller.....	£44.99
Cashbook Combo (above 2 programs combined).....	£59.99
Day by Day.....	£23.99
DG Calc.....	£29.99
Final Accounts.....	£29.99
Gold Disk Office.....	£104.99
Home Accounts I.....	£24.99
Home Accounts II.....	£39.99
Mailshot Plus.....	£39.99
Personal Finance Manager.....	£23.99
Personal Tax Planner.....	£39.99
Protect V5.....	£109.99
Quick Write.....	£49.99
System 3.....	£44.99
System 3E (Extended version of above).....	£59.99
Wordworth (Excellent word processor, package).....	£94.99

## The Post Room

Please make Cheques/PO's payable to "K.G. Leisure". And remember to add £1 for post & packaging (U.K.). You can order using your credit card, by telephone or sending the following details to us at the address below.

Card No.....Exp. Date.....  
Name (on card).....  
Address.....  
Signature.....Amount.....09/91

## The Small Print Room

All items subject to availability. Credit Card orders debited only on day of despatch. Please allow sufficient time for cheque clearance. Prices subject to variation. E & O.E

(Dept AF), 2 Hengoed Hall Drive,  
Cefn Hengoed, Hengoed  
Mid Glamorgan, CF8 7JW.

## The Storage Room

....space for everyone here!....

TDK High Quality 3.5" DSDD Blank Disks Boxes of 10 with labels.....	£8.49
Verbatim High Quality 3.5" DSDD Blank Disks Boxes of 10 with labels.....	£8.29
Unbranded Disks 3.5" DSDD (with labels).....	49p each
Sony High Quality 3.5" DSDD Blank Disks Boxes of 10 with labels.....	£8.49

**IF YOU'RE INTO** Graphics, DTP, word processing or music, if you're in education or if you're working in the publishing or design worlds, sooner or later you'll come into contact with Apple Macintosh computers. Macintoshes are fine machines, but unfortunately (for Mac owners!) everything costs three times as much as it does in the Amiga world. However there are times when it would be very handy to be able to read and write Mac files from the comfort of your own Amiga. Which is where *Mac-2-Dos* comes in.

With the aid of a Macintosh disk drive *Mac-2-Dos* allows you to read and write files in Macintosh format. Not only that, but the program will create icons for transferred files allowing them to be opened on a Mac or Amiga just by clicking on the icon.

Text files, clip art, IFF files, SMF (standard MIDI files) can be transferred, even database files can be passed between one application and another. Most interestingly on the DTP side, *Mac-2-Dos* gives you access to a vast number of Mac DTP bureaus. PostScript files generated by an Amiga DTP program can be saved onto a Mac disk and output to film on a high quality imagesetter just as if they were Macintosh files.

**Installation and operation** is pretty simple. Plug the Macintosh drive and hardware adaptor into the disk drive port of your Amiga. Double-click on the icon from Workbench (or use the CLI) and enter the application. Unfortunately, if you have partitioned your hard disk you have to place a copy of the

If you have any good reason – and there are quite a few – for wanting to transfer files between your Amiga and a Macintosh, then listen up as **Paul Lyons** describes a utility to do just that.

**Mac-to-Dos**  
£79.95  
Silica 081 309 1111

**Mac disk drive**  
£149.95  
Silica 081 309 1111

Thanks to **AppleCentres West** (0272 225661) for providing the Apple external drive.

**File transfer operations are easy: just select your files and click on the Copy button. Icons are added for you.**

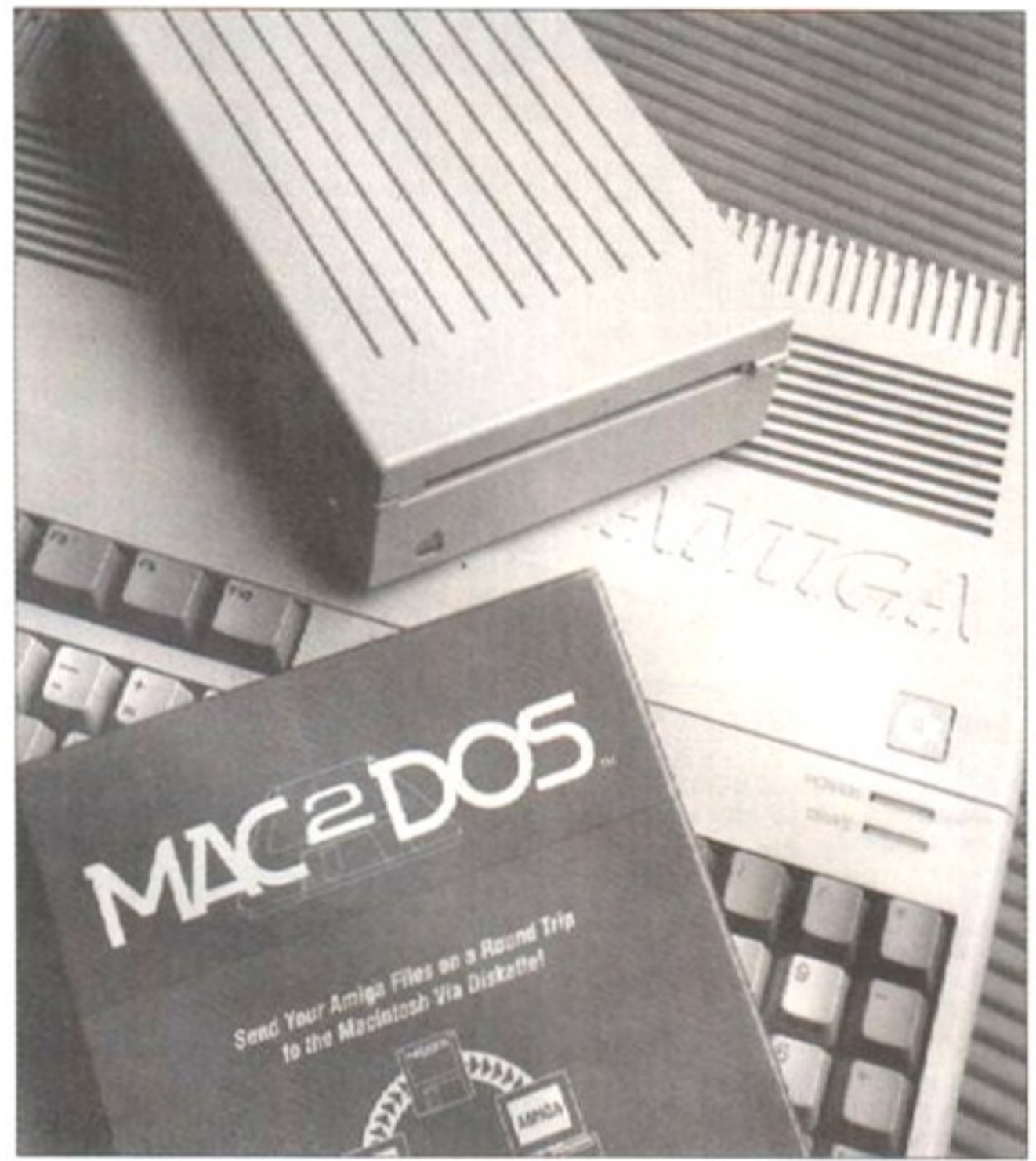

# Mac-2-Dos

Mac-Amiga file transfer  
£79.95 ■ Central Coast Software

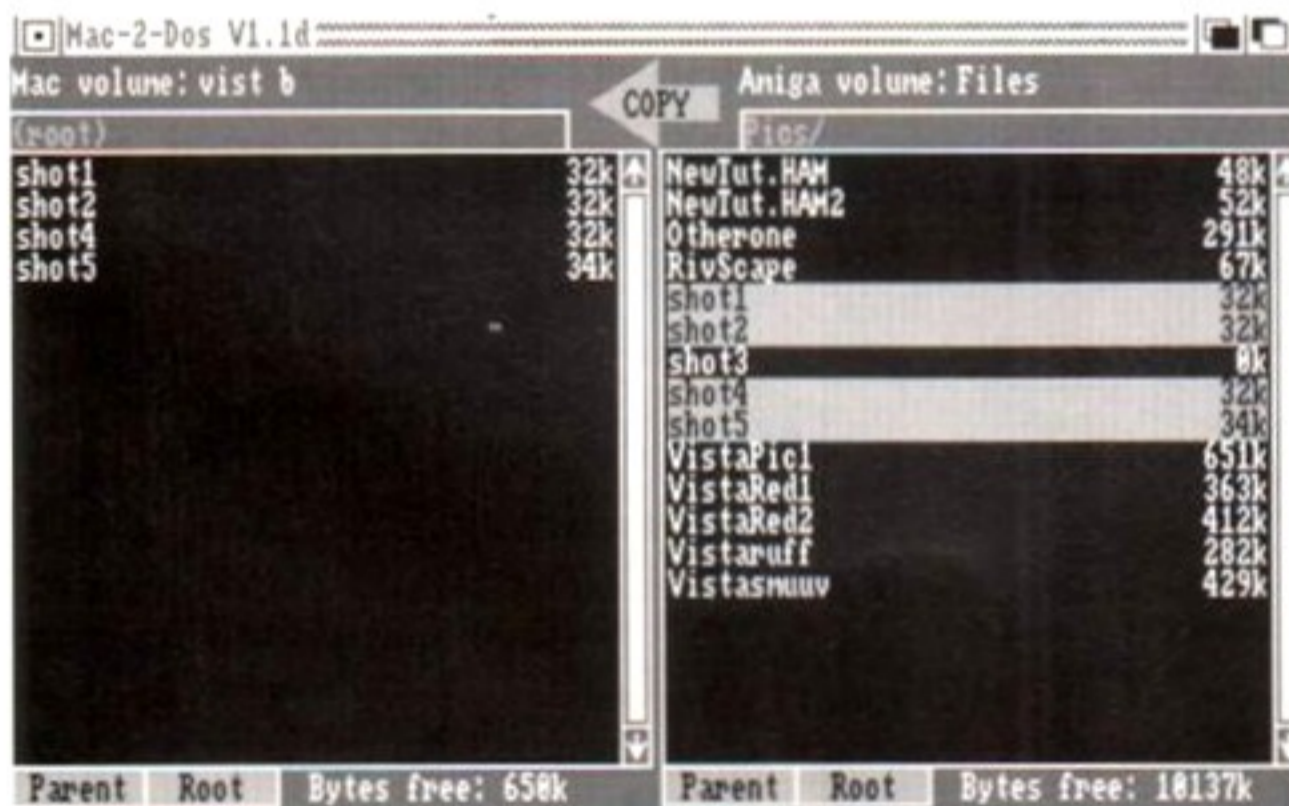

program into every partition from which you wish to copy files. Exchanging files is very simple. Insert a disk into the Mac drive: format and name it as necessary (remember this is a Mac disk and can have up to 31 characters in the name). To copy files, just click on the name of the file to be copied and the copy arrow will change to face in the direction of copy. Check that any conversions required are turned on and click copy. Er... to coin a phrase... that's it!

**One of the nice touches** of *Mac-2-Dos* is that rather than just doing a straight data port, the program can also do file conversions and create icons. For example, if you have an IFF file that you want to paste into a Mac DTP program rather than just doing a straight transfer of the file, *Mac-2-Dos* will convert the file into *MacPaint* format.

In addition, the Macintosh creates icons for all files automatically, using the type of icon to determine which programs can open the file. *Mac-2-Dos* allows you to allocate a Mac icon to outgoing Amiga files (and vice versa). This means that when the file arrives on the receiving computer (say a text file from Protex appearing on a Mac), it appears with the icon of the receiving application (say, *MacWrite*), ready for use.

*Mac-2-Dos* is a fine package with a number of good features and nice touches. Unfortunately, you can't read and write Mac files from the CLI or from within other programs. Unlike its sister program *Dos-2-Dos*

which uses standard Amiga drives, the Macintosh drive cannot be used to read and write standard Amiga files. There was a version which allowed you to do this, but Central Coast software have been unable to secure a sufficient number of the unique disk drive that made the operation possible, so the pack is not longer available.

There are cheaper ways of doing the same task – we use *CrossDOS* to save Amiga files to a PC disk and then read those on the Mac. While *Mac-2-Dos* can't match this system on price it is an elegant one-step solution to the problem of Amiga/Mac file exchange.

## Dos-2-Dos

Amiga-PC file transfer ■ £44.95 ■ CCS

Anyone wanting to transfer files from Amigas to IBM-compatible PCs has a much wider choice of translation software than in the Mac world. Both *CrossDOS* and *MessyDOS* (PD) are excellent and well-established programs. *Dos-2-Dos* works in pretty much the same way as *Mac-2-Dos*, except that where the *Mac-2-Dos* has a Mac-style graphical interface, *Dos-2-Dos* has a CLI-style box, much beloved of PC users.

Unfortunately, like its Mac counterpart, *Dos-2-Dos* has one distinct disadvantage when compared to the other commercial program, *CrossDOS*. To use *Dos-2-Dos* you have to go to the Shell and run the program with all subsequent commands being typed in a separate window. Compare this to *CrossDOS*, which runs in the background and allows the user to address it from the Workbench, the CLI or – most usefully – from within any program. *CrossDOS* can be obtained from Silica (081 309 1111) for £25.

**DOS-2-DOS**

**70%**

### Mac to DOS

**SPEED** ●●●

Not fast, but still much quicker than using comms software or Amiga-PC-Mac systems.

**DOCUMENTATION** ●●●

Acceptable documentation that could have been improved by the addition of screen-shots.

**ACCESSIBILITY** ●●●

Reasonably easy to understand, although the text-only manual doesn't help matters.

**FEATURES** ●●●●

Automatic icon creation and file conversion greatly enhance the basic task of conversion.

**VALUE** ●●

£80 for the software plus £150 for the disk drive makes this a pricey conversion system.



**74%**

ATOMIC  
ROBOKID  
ONLY  
£7.99

CORPORATION +  
MISSION DISK  
ONLY  
£12.99

# TURBOSOFT

DAMOCLES +  
MISSION DISK 1  
ONLY £12.99

CENTURIAN  
ONLY  
£17.99

## FORTHCOMING ATTRACTIONS

4D Boxing	£17.99
Action Stations (1 Meg)	£22.99
Adidas Golden Shoe	£17.99
AH-73M Thunderhawk	£17.99
Alcatraz	£17.99
AMOS 3D	£24.99
Arnhem	£17.99
Battlechess 2	£20.99
Billy the Kid	£17.99
Birds of Prey	£24.99
Blade Warrior	£17.99
Champion of the Raj	£17.99
Championship Athletics	£17.99
Crimewave	£17.99
Cruise for a Corpse	£17.99
Darkman	£17.99
Das Boot	£20.99
Death Knights of Krynn	£20.99
Demoniak	£20.99
Deuteros (The Next Millenium)	£17.99
Double Double Bill	£24.99
Elf	£17.99
Executioner	£17.99
Final Fight	£17.99
Flight of the Intruder	£20.99
Gauntlet 3	£17.99
Hunter	£20.99
Jetfighter 2	£22.99
Knights of Legend	£20.99
Last Ninja 3	£17.99
Logical	£14.99
Midwinter 2	£20.99
Moonbase	£24.99
Myth	£17.99
Navy Seals	£17.99
Plotting	£17.99
Sarakon	£20.99
Secret Weapons of the Luftwaffe	£20.99
Shanghai 2 - Dragons Eye	£24.99
Silent Service 2	£24.99
Sim Earth	£24.99
Spirit of Excalibur (1 Meg)	£20.99
Stormball	£17.99
Swap	£17.99
Terminator 2	£17.99
Wing Commander (1 Meg)	£24.99
Worlds At War	£17.99
World Class Cricket	£17.99

Please note that the majority of the forthcoming attractions are not released at time of going to press. These will be despatched within 24 hours of release subject to availability.

## ACCESSORIES

1/2 Meg Upgrade + Clock	£24.99
2M Joystick/Mouse ext. lead	£6.99
40 Lockable Disk Box	£5.99
80 Lockable Disk Box	£7.99
94 Banx Stackable Box	£13.99
150 Posso Stackable Box	£17.99
Amiga 4 Player Adaptor	£7.99
Amiga 500 Dust Cover	£4.99
Box 10 Bulk Disks	£6.99
Box 10 Sony Branded Disks	£9.99
Cheetah 125+	£7.99
Commodore 1084 Monitor	£259.99
Disk Cleaning Kit	£2.99
Golden Image GI600 Mouse	£24.99
Golden Image Optical Mouse	£49.99
Golden Image Scanner	£189.99
Maverick Game Controller	£14.99
Mouse House	£3.99
Mouse Mat 6mm	£4.99
Philips CM8833 Monitor	£279.99
Pro 5000	£10.99
Pro 5000 Clear Extra	£12.99
Quickjoy Jetfighter	£10.99
Quickjoy Mega Board	£19.99
Quickjoy Topstar	£19.99
Quickshot Python	£8.99
Quickshot Python Microswitch	£10.99
Roll 1000 labels 3.5"	£9.99
Star LC200 Colour Printer	£219.99
Star LC24-200 Colour Printer	£289.99
Star LC24-200 Mono Printer	£249.99
Stingray Hand Held Joystick	£13.99
Zipstick	£12.99

## TOP 50 CHART

1 Meg Cricket	£18.99
4D Driving	£17.99
Advanced Destroyer Sim	£17.99
Amos Compiler	£20.99
Armour Geddon	£17.99
Atomino	£17.99
Bandit Kings of Ancient China	£22.99
Cadaver Levels	£12.99
Cardinal of the Kremlin	£17.99
Centurian	£17.99
Chuck Rock	£17.99
Crystals of Arborea	£17.99
Cybercon 3	£17.99
Demoniak	£20.99
Duck Tales	£17.99
European Superleague	£17.99
Eye of the Beholder	£20.99
F15 Strike Eagle 2	£24.99
F19 Stealth Fighter	£18.99
Final Whistle	£8.99
Gem - X	£16.99
Genghis Khan	£22.99
G.O.D.S.	£17.99
Gunboat	£17.99
Hero Quest (Gremlin)	£17.99
Jahangir Khan's Squash	£17.99

Kick Off 2	£12.99
Lemmings	£17.99
Life and Death	£17.99
Lords of Chaos	£14.99
Man Utd. Europe	£17.99
Mega Traveller 1	£20.99
Mercs	£17.99
Metal Mutant	£17.99
P.G.A. Tour Golf	£17.99
Powermonger	£20.99
P.P. Hammer	£17.99
Prehistorik	£17.99
Proflight	£29.99
Railroad Tycoon	£24.99
R.B.I. 2 Baseball	£20.99
R-Type 2	£17.99
Search for the King	£19.99
Secret of Monkey Island (1 Meg)	£17.99
Shadow Dancers	£17.99
Sim City + Populous	£19.99
Speedball 2	£17.99
Super Cars 2	£17.99
Switchblade 2	£17.99
Toki - Goes Wild	£17.99
Winning Tactics	£6.99

## CLASSIC COLLECTION

3D Construction Kit	£34.99
688 Attack Sub	£17.99
A10 Tank Killer	£24.99
BAT	£20.99
Battlechess	£17.99
Battle Command	£17.99
Balance of Power 1990	£20.99
Bards Tale 3	£17.99
Blitzkrieg 1 Meg	£22.99
Blue Max	£17.99
Bridge Player 2150	£20.99
California Challenge (T.D. II Disk)	£8.99
Champions of Krynn	£20.99
Chaos Strikes Back	£17.99
Chase H.Q.	£17.99
Chase H.Q. 2	£17.99
Chess Champion 2175	£20.99
Colossus Chess X	£12.99
Deluxe Scrabble	£14.99
Dragons Lair (1 Meg)	£26.99
Dragons Lair 2	£29.99
Dragon Wars	£17.99
Dungeon Master (1 Meg)	£17.99
European Challenge (T.D. II)	£8.99
F-16 Combat Pilot	£17.99
F29 Retaliator	£17.99
Flight Simulator II	£24.99
Golden Axe	£17.99
Harpoon (1 Meg)	£20.99
Hillstar	£17.99
Indianapolis 500	£17.99
It Came From the Desert	£14.99
Jack Nicklaus Courses vol 1	£9.99
Jack Nicklaus Int. Courses	£9.99
Jack Nicklaus Unlimited Golf (1 Meg)	£20.99
Kick Off 2 (1 Meg)	£17.99
Killing Cloud	£17.99
Knights of Crystallion	£20.99
Leisuresuit Larry I	£20.99
Leisuresuit Larry 3 (1 Meg)	£26.99
Lotus Turbo Challenge	£17.99
M1 Tank Platoon	£20.99
Maniac Mansions	£17.99
Metal Masters	£17.99
Midnight Resistance	£17.99
Midwinter	£20.99
MIG 29 Fulcrum	£24.99
Murder	£17.99
Muscle Cars (T.D. II Disk)	£8.99
NAM	£20.99
NARC	£17.99
Nightshift	£17.99
Operation Stealth	£17.99
Pang	£17.99
Pirates	£17.99
Player Manager	£12.99
Police Quest 2 (1 Meg)	£24.99
Pools of Radiance (1 Meg)	£20.99
Populous	£17.99
Populous Promised Lands	£7.99
Prince of Persia	£17.99
Pro Tennis Tour 2	£17.99
Rainbow Island	£17.99
Red Storm Rising	£17.99
Rick Dangerous 2	£17.99
Robocop	£17.99
Robocop 2	£17.99
Saint Dragon	£17.99
Shadow of the Beast 2	£22.99
Shadow Warrior	£17.99
Space Ace	£27.99
Steve Davis Snooker	£9.99
Super Cars (T.D. II Disk)	£8.99
Super Monaco G.P.	£17.99
Supremacy	£20.99
SWIV	£17.99
Team Suzuki	£17.99
Team Yankee	£20.99
Test Drive II	£17.99
Their Finest Hour	£20.99
Total Recall	£17.99
Turrican 2	£17.99
TV Sports Basketball	£14.99
Ultima IV	£17.99
Ultima 5	£20.99
UMS 2 (1 Meg)	£20.99
Viz	£14.99
White Death 1 Meg	£22.99
Wings (1 Meg)	£18.99
Wolfpack (1 Meg)	£20.99
Wonderland	£20.99
Z-Out	£17.99

### POWER UP - £18.99

Turrican, X-Out, Rainbow Island, Altered Beast, Chase HQ.

### COMPUTER HITS II - ONLY £7.99

Tetris, Black Shadow, Golden Path, Joe Blade

### PLATINUM COLLECTION - ONLY £17.99

Ghouls N Ghosts, Strider, Forgotten Worlds, Black Tiger

### SUPREME CHALLENGE FLIGHT

#### COMMAND - ONLY £12.99

Eliminator, Skychase, Strike Force Harrier, Lancaster, Skyfox II

### WHEELS OF FIRE - ONLY £9.99

Chase HQ, Turbo Outrun, Powerdrift, Hard Drivin'

### POWERPACK - ONLY £14.99

Xenon 2, Bloodwych, TV Sports Football, Lombard Rally

### VIRTUAL REALITY VOLUME 1 - ONLY £24.99

Midwinter, Carrier Command, Int. Soccer Challenge, Starglider 2, Stunt Car Racer

### TEST DRIVE 2 COLLECTION - ONLY £20.99

Test Drive 2, Muscle Cars, European Challenge, Super Cars, California Challenge

### WORLD CUP COMPILATION - ONLY £7.99

Tracksuit Manager, Kick Off, International Soccer

### PHANTASIE BONUS EDITION - ONLY £20.99

Phantasie 1, Phantasie 3, Qwestron 2

### TRIAD 3 - ONLY £14.99

Rocket Ranger, Speedball, Blood Money

### SOCCER MANIA ONLY £9.99

Football Manager 2, Microprose Soccer, Gazzas Soccer, Football Manager World Cup Edition

### MIND GAMES - ONLY £14.99

Austerlitz, Waterloo, Conflict in Europe

### HOLLYWOOD COLLECTION - ONLY £20.99

Robocop, Ghostbusters 2, Indiana Jones & Last Crusade, Batman the Movie

## ● SPECIAL OFFERS ● SPECIAL OFFERS ●

3D Pool	£7.99
Airborne Ranger	£9.99
Art of Chess	£4.99
Atomic Robokid	£7.99
Baal	£4.99
Battle Squadron	£4.99
Boulderdash Const Kit	£4.99
Brian Clough's Football	£6.99
Captive	£9.99
Castle Master	£9.99
Centrefold Squares	£7.99
C.J.'s Elephant Antics	£6.99
Colorado	£4.99
Continental Circus	£7.99
Corporation	£12.99
Corruption	£7.99
Cosmic Pirate	£4.99
Count Duckula	£6.99
Daily Double Horse	£7.99
Racing	£7.99
Defender of the Crown	£7.99
Deluxe Strip Poker	£7.99
Double Dragon	£7.99
Drakken	£6.99
Fantasy World Dizzy	£6.99
Fast Food	£6.99
F/ball Manager II + Exp Kit	£9.99

Fools Errand	£7.99
Full Metal Planete	£9.99
Gauntlet II	£7.99
Gunship	£12.99
Indy Jones the Adventure	£9.99
International 3D Tennis	£7.99
Iron Lord	£9.99
James Pond	£7.99
Jumping Jackson	£7.99
Kid Gloves	£7.99
Laser Squad	£7.99
Leaderboard	£6.99
Little Puff	£6.99
Loom	£9.99
Lords of the Rising Sun	£11.99
Manic Miner	£7.99
Maya	£4.99
Night Hunter	£9.99
Ninja Spirit	£7.99
Ninja Warrior	£7.99
North And South	£7.99
Persian Gulf Inferno	£4.99
Pro Tennis Tour	£9.99
Puffys Saga	£7.99
Quest for the Time Bird	£6.99
Rocket Ranger	£7.99
Sherman M4	£7.99

Shinobi	£7.99
Silent Service	£9.99
Sim City	£14.99
Sorcery Plus	£4.99
Speedball	£7.99
Spy Vs Spy	£4.99
Spy Vs Spy II	£4.99
Spy Vs Spy III	£4.99
Stunt Car Racer	£9.99
Super Gridrunner	£4.99
Super Off Rd Racer	£9.99
Superstar Ice Hockey	£7.99
Sword of Sodan	£7.99
Tank Attack	£7.99
Tennis Cup	£7.99
The Cycles	£7.99
Time Machine	£7.99
Treasure Island Dizzy	£4.99
Turrican	£9.99
Tusker	£7.99
TV Sports Football	£9.99
Twin World	£7.99
Uninvited	£9.99
X-Out	£6.99
Zak McCracken	£9.99
Zombi	£9.99

Please charge my Access/Visa No: ..... Expiry date: .....

## ORDER FORM

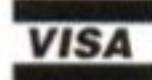

Customer Number

Please supply me with the following for

Computer .....

Titles Price

DATE: .....

NAME: .....

ADDRESS: .....

.....

.....

.....Post Code.....

TEL: .....

AMIGA FORMAT SEPT. '91

Please make cheques & PO payable to **Turbosoft**

Credit card orders taken, payment cashed only on despatch. Orders under £5 add 75p P&P per item. For First Class add 75p P&P per item UK only. EEC countries add £2.00 per item. Non EEC countries add £3.00 per item. Express airmail £4.00 per item. All items subject to availability. All prices subject to change without notice.

E. & O. E. Please note: Mail Order companies may take up to 28 days to deliver goods from receipt of order. Please allow for cheque clearance

**TOURNAMENT GOLF**  
£7.99

**WINNING TACTICS ONLY**  
£6.99

# TURBOSOFT

**GRAND NATIONAL ONLY**  
£7.99

**ART OF CHESS ONLY**  
£4.99

## EDUCATIONAL

Answer Back Junior .....£13.99  
 Answer Back Senior .....£13.99  
 Better Maths (12-16).....£16.99  
 Better Spelling (8-14).....£16.99  
 Dinosaur Discovery Kit .....£16.99  
 French Mistress .....£13.99  
 Fun School 2 (under 6) .....£13.99  
 Fun School 2 (6-8) .....£13.99  
 Fun School 2 (8+) .....£13.99  
 Fun School 3 (under 5) .....£16.99  
 Fun School 3 (5-7) .....£16.99  
 Fun School 3 (7+) .....£16.99  
 German Master .....£13.99  
 Goofy's Railway Express .....£13.99  
 Hooray/Henrietta .....£16.99  
 Italian Tutor .....£13.99  
 Junior Typist (5-10) .....£12.99  
 Lets Spell At Home .....£14.99  
 Lets Spell At Shops .....£14.99  
 Lets Spell Out and About .....£14.99  
 Magic Maths (4-8) .....£16.99  
 Maths Mania (8-12) .....£16.99  
 Mickey's Crossword Maker .....£13.99  
 Mickey's Runaway Zoo .....£13.99  
 My Paint .....£22.99  
 Postman Pat .....£6.99  
 Prof. Looks at Words .....£16.99  
 Prof. Makes Sentences .....£16.99  
 Prof. Plays a new Game .....£19.99  
 Puzzle Book Vol 1 .....£14.99  
 Puzzle Book Vol 2 .....£14.99  
 Spanish Tutor .....£13.99  
 Spellbook (4-9) .....£14.99  
 The 3 Bears .....£16.99  
 Things to do with Numbers .....£14.99  
 Things to do with Words .....£14.99

## SPRING SAVERS • SPRING SAVERS • SPRING SAVERS

<b>EYE OF THE BEHOLDER</b> £20.99	<b>SECRET OF MONKEY ISLAND</b> £17.99	<b>IN NOW LEMMINGS</b> ONLY £16.99	<b>F19 STEALTH FIGHTER</b> £19.99	<b>DOUBLE DRAGON 2 KICKSTART 1.2</b> ONLY £7.99
<b>1 MEG CRICKET</b> £14.99	<b>SWORD OF SODAN</b> ONLY £7.99	<b>F15 STRIKE EAGLE 2</b> 1 MEG ONLY £24.99	<b>PGA TOUR GOLF</b> ONLY £17.99	<b>AMOS COMPILER</b> ONLY £20.99
<b>COMING SOON BATTLECHESS 2</b> ONLY £20.99	<b>CUMANA EXTERNAL DRIVE + 10 BLANK DISKS</b> ONLY £69.99	<b>TURRICAN 2</b> ONLY £16.99	<b>G.O.D.S.</b> ONLY £17.99	<b>PROFLIGHT FROM HISOFT</b> £29.99
<b>SEARCH FOR THE KING</b> £20.99	<b>BARDS TALE 2 NOW IN AT</b> £7.99	<b>ROCTEC SLIM DRIVE (RF332C) TOP QUALITY NO.1 AMIGA SHOPPER</b> ONLY £59.99	<b>SUPERPLAN (1 MEG)</b> £39.99	<b>CAN DO ONLY</b> £39.99
<b>JAMES POND</b> ONLY £7.99	<b>BACK IN PACLAND AND PACMANIA ONLY</b> £7.99 EACH	<b>FULL METAL PLANETE</b> ONLY £9.99	<b>CAPTIVE</b> £9.99	<b>LOOM</b> £9.99
<b>INDIANA JONES ADV + ZAK MCKRACKEN</b> £14.99	<b>1/2 MEG UPGRADE + CLOCK</b> ONLY £24.99	<b>WORDWORTH A WRITERS DREAM</b> ONLY £99.99	<b>COMING SOON SECRET WEAPONS OF THE LUFT-WAFFA ONLY</b> £20.99	<b>SIM CITY ARCHITECT 1 OR 2</b> ONLY £12.99

## UTILITIES

A.M.A.S.....£79.95  
 A.M.O.S.....£32.99  
 Animation Studio.....£79.99  
 Can Do.....£39.99  
 Deluxe Music Const. Kit.....£49.99  
 Deluxe Paint 3 .....£59.99  
 Deluxe Print 2 .....£34.99  
 Deluxe Video 3 .....£59.99  
 Devpac 2.....£44.99  
 Digicalc .....£27.99  
 Digi Paint 3 .....£59.99  
 Digiview Gold.....£119.99  
 Hisoft Basic .....£59.99  
 Home Accounts .....£22.99  
 Kindwords .....£37.99  
 Lattice C V5 .....£169.99  
 Mastersound .....£32.99  
 Mavis Beacons Typing.....£19.99  
 Mugician .....£14.99  
 Musix X 1.1 Version.....£89.99  
 Music X Junior .....£49.99  
 Pagestream .....£99.99  
 Photon Paint 2 .....£19.99  
 Photon Video .....£24.99  
 Prodata .....£59.99  
 Professional Page V2.00 .....£179.99  
 Protect Ver. 5.....£109.99  
 Quartet.....£34.99  
 Sculpt 4D .....£399.99  
 Sound Express .....£34.99  
 Superbase Personal 2 .....£29.99  
 Superbase Professional.....£149.99  
 Superplan .....£39.99  
 Transwrite .....£59.99  
 Virus Killer.....£8.99

## MEGA BUYS

Welltris.....£9.99  
 Light Corridor.....£9.99  
 Mystical.....£9.99  
**OR**  
 All 3 for.....£19.99

## SPECIAL DOUBLE BILL FEATURE FROM INFOGRAMMES.

**Don't miss out, book early!**  
 SCREEN 1 | SCREEN 2  
 SIM CITY + POPU- | GENIS KHAN  
 LOUS | ONLY £22.99  
 BOTH ONLY £19.99 | AMIGA FORMAT 89%

F16 Falcon...£13.99

Falcon Mission 1...£9.99  
 Falcon Mission 2...£9.99  
**OR**  
 All 3 for...£29.99

## 10 MEGA GAME PACK ONLY £21.99

Teenage Queen, Captain Blood, Safari Guns, Tin Tin on the Moon, Bubble +, Purple Saturn Day, Krypton Egg, Jumping Jackson, Stir Crazy Bobo, Hostages

## WICKED GAMES PACK ONLY £6.99

Bouncer, Paccie, Backgammon, Invaders, Ball Raider 2, Swooper, Spaceballer, Diablo, Zirax, Othello

## ADVENTURE PACK ONLY £12.99

African Raiders, Emmanuelle, Freedom, 20,000 Leagues Under The Sea

## AMERICAN DREAMS ONLY £6.99

Bubble Ghost, Operation Neptune, Hostages, Super Ski

## UTILITY PACK incl.

Comic Setter, Fantavision, Spritz Paint

**ONLY £29.99**

## HIGH ENERGY ONLY £16.99

Tin Tin on the Moon, Teenage Queen, North & South, Fire & Forget, Hostages

## FUTURE DREAMS ONLY £6.99

Warlocks Quest, G-Nius, Spidertronic, Purple Saturn Day

## SUPER QUINTET ONLY £6.99

Chamonix Challenge, Bubble Ghost, Warlocks Quest, Passengers on the Wind 1 & 2

## SCREEN GEMS MEGA PACK

Featuring: A500, P.S.U., modulator, mouse, Nightbreed, Days of Thunder, Back to the Future, Deluxe Paint 2, Shadow of Beast 2, plus Powerpack compilation, 10 blank disks + labels, mouse mat, dust cover, 40 lockable disk box, disk cleaning kit, Microblaster microswitched joystick.  
 All this plus the official 1/2 Meg memory expansion board giving you a full 1000K of memory  
**Only £409.99 inc. VAT & delivery**



## MEGA OFFER! MEGA OFFER!

For every thirty pounds spent you can choose one of the following titles absolutely **FREE!!**  
 (Available singularly @ £3.99 ea) Operation Neptune, Tin Tin on the Moon, Bubble +, Safari Guns, Hawkeye, Interphase, Rotor, Action Service, Toyotees, Ballistix Warhead.  
 Plus spend over £40 you can choose one of the £6.99 compilations **FREE!!**  
 (Games subject to availability - games may be substituted)

## STAR PRINTERS

LC - 200 - £229.99  
 LC24-200 Mono - £269.99  
 LC24-200 Colour - £309.99  
 incl. printer cable & 200 sheets listing paper

# Turbosoft

Unit 6 & 7 Acacia Close,  
 Cherrycourt Way Industrial Estate,  
 Stanbridge Road, Leighton Buzzard  
 Beds. LU7 8QE

Telephone hours are:  
 Monday to Thursday 9.00am to 8pm  
 Friday 9.00am to 5pm  
 Saturday 10.00am to 5pm  
 (5 lines)

Showroom hours are:  
 Monday to Friday 9.00am to 6pm  
 Saturday 10.00am to 5pm

**All prices include VAT**

**Tel: (0525) 377974**

**Fax: (0525) 852278**

**Crazy Saturday every 2nd week of the month. Loads of extra special offers on new releases as well as older titles. (Offer applies to personal callers to showroom only)**

## (Personal callers welcome) HOW TO FIND US.....

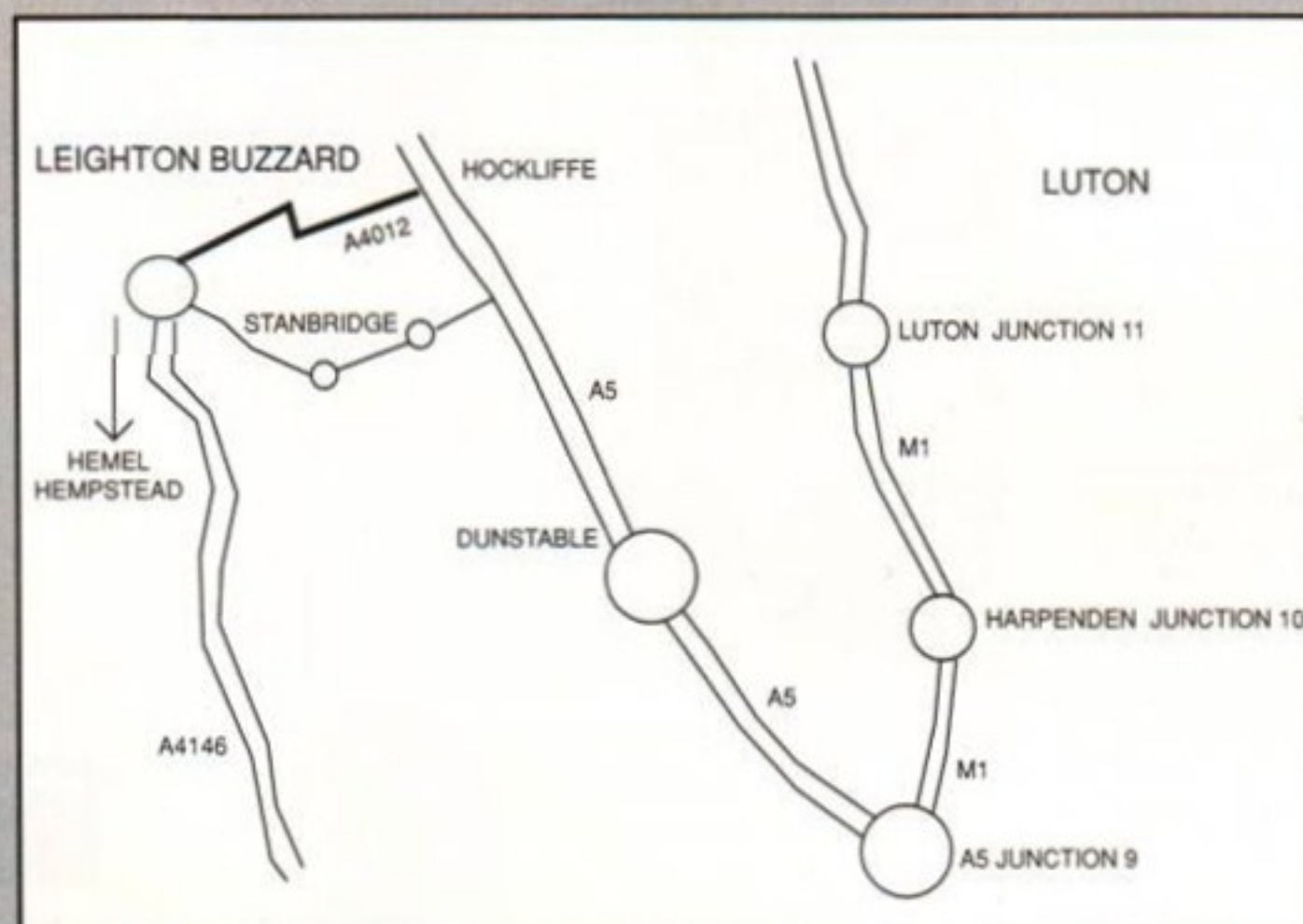

Maps showing direct routes from the motorway and A5

NBS

NBS

NBS

NBS

NBS

NBS

NBS

NBS

NBS

## PUBLIC DOMAIN LIBRARY

NBS

## MEGADEMO MANIA

We've been asked recently for more megademos. So as requested here's the definitive list of the greatest. Please note: Our numbering system started at 100, so early 100 are about 2 years old!

- D 001 ALCATRAZ MEGADEMO 4 (3 DISKS) Brilliant! One of the biggest.
- D 002 TRIANGLE MEGADEMO Good scrolls and vectors. Bit dated now.
- D 004 DARKNESS MEGADEMO Original loader, but otherwise bland.
- D 008 STATIC BYTES MEGADEMO Six parts, clever stuff.
- D 014 CRYPTOBURNERS MEGADEMO 2 Contains some good demos. worth a look.
- D 030 CAVE MEGADEMO Certainly not one of the best. Colourful though.
- D 034 BUDBRAIN MEGADEMO (2 DISKS) A classic! Not to be missed but beware of the very risqué cartoons.
- D 035 CRIONICS MEGADEMO Another great! Famous for the Madonna part.
- D 046 ACU MEGADEMO An early demo from Oz. They had more to learn.
- D 061 POSSESSED MEGADEMO (2 DISKS) Good animated space intro
- D 067 MIRAGE MEGADEMO (1 MEG) Yet another good one. Some good FX.
- D 078 CRIONICS NEVERWARE (1 MEG) Famed for the brill Madonna graphic.
- D 080 KATHARIS MEGADEMO From Poland! Famous X-Copy demo, plus.
- D 081 INTUITION MEGADEMO Includes the flashiest ever acid demo.
- D 091 FILLET THE FISH Similar to PUGGS, but not as good, still brill.
- D 123 FASHION MEGADEMO Early stuff! Better was to come
- D 125 DEXION MEGADEMO Underrated at the time. Old but good
- D 127 SCOOPLEX MEGADEMO Showed great promise of the future
- D 132 ARCADIA MEGADEMO Ok I've forgotten what it's like...try it!
- D 135 REBELS MEGADEMO Excellent for its time. Good demos.
- D 136 ALCATRAZ MEGADEMO Again underrated at the time but very good.
- D 138 RAF MEGADEMO (2 DISKS) Still fresh after all this time!
- D 140 KEFRENS MEGADEMO Collectors item? Great programming.
- D 141 PHENOMENA MEGADEMO Brilliant group today, always been good.
- D 146 RSI MEGADEMO (2 DISKS) An all time great! Still good today! Great music and graphics. A must!!
- D 150 IAN & MICK MEGADEMO Inc. classic toilet door demo.
- D 151 DEATHSTAR MEGADEMO Brilliant cosmic explosion as intro.
- D 153 PUGGS IN SPACE Not generally classed as a megademo, but not to be missed. Great for the kids.
- D 160 TRILOGY MEGADEMO (2 DISKS) Includes game, a classic, contains a joke, or is it a bug? You decide.
- D 161 PREDATORS MEGADEMO (2 DISKS) Don't miss this one, great sound, graphics and game. Another classic.
- D 162 KEFRENS MEGADEMO 8 Yet another classic! and not to be missed.
- D 166 SILENTS MEGADEMO Early Silents, the brilliance is born!
- D 180 SCOOPLEX MENTAL HANGOVER Another classic which pushed the boundaries of the Amiga light years on.
- D 211 KEFRENS PYRAMIDS MEGADEMO Clever but so so
- D 214 GOLDFIRE MEGADEMO Not at all bad for beginners. Nice ilps!
- D 223 BUDBRAIN MEGADEMO 2 Not quite as good as the first, still good!
- D 225 HORIZON MEGADEMO (Sleeping Bag) Superb ray traced anim. Great

## LATEST &amp; GREATEST PD LIST

- D 033 TOMSOFT TRIP TO MARS. Vector graphics with a theme \*
- D 186 COMA DEMO. Flashy acid demo, together with more great demos \*
- D 190 RSI CEBIT DEMO. Terrific demo, with the best ever music \*
- D 220 PAH! SIMPLE STUFF VOL 2 - NBS Demo compo inc crusaders cine fex, great
- D 221 PAH! SIMPLE STUFF 3....Dragons Lair, TimeWarp demo and more
- D 222 CRIONICS TOTAL DESTRUCTION (1 MEG)....Some great effects.
- D 236 GOLDFIRE ULTIMATE FX....This group continues to improve!!
- D 238 ANARCHY PRESENTS DEXION PARTY DEMOS 1....Recent good demos.
- D 239 ANARCHY SMOKER COMPILATION....And some more!
- D 241 ANGELS MEGADEMO....Good but not meg
- D 242 3-D DEMOS....Get out your 3-D glasses and CHECK THESE OUT!
- D 243 KEFRENS - THE WALL....Great intro! Good graffix, then so so
- D 259 PHENOMENA ENIGMA Absolutely Awesome!!! Fantastic, Get it
- D 260 6 OF 1 (PRISONER DEMO) Not meg but great subject for a demo.
- D 261 SIMPSONS DEMO BY DECAF: Probably the best so far. (1 MEG)
- D 264 ANALOGUE MEGA DEMO. Great intro and novel demo selection.
- D 265 GALLOW MEGADEMO Purple Haze! Great colours, fair demos.
- D 266 ALJORA MEGA DEMO. Dramatic intro, good music, Ham Bobs!
- D 267 BASS MEGA DEMO. Great housey music throughout.
- D 268 CHAOS ROCK A fantastic lightshow based on Fractal pat terns!
- D 269 PULLING THE TRIGGER. Loved the music! Well presented demos (1 meg)
- D 272 SIMPSONS DEMO BY EQUINOX: Loadsa pics and music mix.
- D 273 SIMPSONS DEMO BY FREEHAND Great slides and sounds.
- D 294 SILENTS: ICE MEGADEMO (1 MEG) Brill demo, More interesting for coders.
- D 295 TOMSOFT: VIRTUAL WORLD (1 MEG) Its a classic. Best this year.
- D 296 MAGNETIC FIELDS: HYSTERISIS. Good demo, now loader friendly.
- S 377 NEWTEK DYNAMIC HI-RES SLIDESHOW (1 MEG)...piccys from the ads.
- S 380 ADDAMS FAMILY SLIDESHOW....Collection from the cult series.
- S 381 FRAXION FANTASY SLIDESHOW....Great presentation, great piccys.

- S 386 BLOODSPORT SLIDESHOW....For oriental sports fans!
- S 390 LIVE CORRUPTION-NAPALM DEATH SLIDESHOW....Heavy!
- S 393/4/5 DEFINATIVE MADONNA SLIDESHOW...(3 disks) 1 meg & 2 drives

- S 441 INVISIBLE WORLD SLIDESHOW. See it and itch. Micro bugs
- H 545 JET FIGHTER ANIM...Similar to The Run, but far better (1 MEG)
- H 546 AGATRON ANIM 10... Enterprise leaving dock. Superb (1 MEG)
- H 547 STEVE'S ANIM No 1...Some super little anims. Have a look.
- H 548 STEVE'S ANIM No 2...More cute little anims. I love 'em.
- H 549 AGATRON ANIM FLEET MANOEUVRE (1 MEG)...Tobias best yet. Very impressive.
- H 555 BATMAN THE MOVIE ANIMATION (1 MEG)....Good funny cartoon
- H 559 MAGICIAN AND JOGGER ANIMATIONS (1 MEG)...Ray traced anims.
- H 560 CAR & UNICYCLE ANIMATION (1 MEG)....Brill anim, a must for fans!
- H 561 STEVE'S ANIMS 3 (1 MEG)....More of these cute little anims
- H 562 STEVE'S ANIMS 4 (1 MEG)....From Steve Packer... (as featured)
- H 563 STEVE'S ANIMS 5 (1 MEG)....briefly in this magazine)
- H 564 EVIL DEAD DEMO (1 MEG)... Get the goulies, before they get yours
- H 565 RGB & FOCUS (1 MEG)....The famous 'stretching nose' animation!
- H 570/1 TRON ANIMATION (1 MEG & 2 DISKS) Great anim based upon the film
- H 572 FRANKLYN THE FLY (1 MEG)...Simple but effective and funny..
- H 607 WINGS ANIMATION. Brilliant stuff and long too! (1 MEG)Good
- H 573 TOO MUCH 3D (1 MEG)....The spaceship flies out of the screen!
- H 576 IRAQ DEMO Amusing animation of what might have been
- H 577 MORE AEROTOONS More in the series of Stealthy cartoons
- H 578 ROBOCOP ANIMATION You have 15 seconds to comply etc. In colour
- H 579 MORE CLASSY ANIMATIONS More cute anims from Steve Packer
- H 582 BATTLE CHESS DEMO Great game demo (even if you cannot play chess)
- X 110 FRAXION HORROR Great cartoon graphic demo of nasty stuff.

## POWER DEMOS (All demos in this section require loads of memory)

- P 001/2 WALKER DEMO 1 (2 MEG & 2 DISKS)
- P 003/4 WALKER DEMO 2 (2 MEG & 2 DISKS)
- P 005/6/7 LOST IN SPACE (2 MEG & 3 DISKS)
- P 008/9 THE SENTINAL (3 MEG & 2 DISKS)
- P 019/20 VAUX KILLER (2.5 MEG & 2 DISKS) ...OK but not brill anim
- P 021-026 UPGRADE (1.5 MEG & 2 DRIVES 6 yes 6 disks!!!) multi part anim
- P 010/11 HEADKICK ANIM (2 MEG & 2 DISKS plus HARD-DRIVE)
- P 012/3/4 STATION AT KHERN (2 MEG & 3 DISKS)
- P 030/1 DRAGONS LAIR 2 GAME DEMO Superb (3 MEG, 2 DISKS)
- P 032/3/4 BUZZED Great Ray traced anim (2 MEG, 3 DISKS)
- P 035/6/7/8 AUTOMATED LIGHT (BATTLESTAR GALACTICA) (3 MEG, 4 DISKS)
- P 044/5 ANTI LEMMING DEMO (2 MEG)Excellent Eric Shwartz animation.

## MUSIC

- M 005 MAHONEY & KAKTUS Brilliant music disk
- M 030 DIGITAL CONCERT 2: Over 12 mins of mixed house music.
- M 070 CRUSADERS BACTERIA Stunning sound and graphics.
- M 170 NEWTRONS MUSIC DISK 'HEADBANGER' You will not believe this!!
- M 197 GROOVE IS IN THE HEART....Good re-mix of chart hit.
- M 200/1/2 SAE AMAZING TUNES 2 (3 DISKS 1 MEG)...Superb!
- M 212 MAG FIELDS CHIP FESTIVAL....Another huge collection.
- M 216/7 RAF MEGA MIX 2 (2 DISK SET)....Good quality music mix.
- M 226 DYNAMITE BEATS 4....Another very classy music disk from MAX.
- M 230 DEXION PARTY MUSIC AND PICCYS....A good disk as always
- M 232 ALCATRAZ MUZIC....Classy presentation, 3 good tracks!!!
- M 269 ALCATRAZ MORE THAN MUSIC. Superb, thought slightly bugged.

## UTILITIES

- U 103 ULTIMATE VIRUS KILLER...Updated now knows 124 viruses
- U 107 VIRUS CATALOGUE. What it does, how, and where from.
- U 225 AMIBASE A good database. Start a disk catalogue now.
- U 233 UEDIT Good Public Domain Wordprocessor.
- U 267 ELECTROCAD DEMO (1 MEG) Circuit diagram design tool. No save in demo.
- U 280 LABEL PRINTER... Helps print your custom labels.
- U 306-U312 Clip Art...Collection of clip art for DTP etc.
- U 505 to U508 SOUNDTRACKER SAMPLE DISKS...Instrument disks.
- U 611 MED 3.11. Latest version of this great music utility.
- U 613 ICON MAGIC. Loads of icon utilities.
- U 616 DESK TOP PUBLISHER. Don't know if its good. Its all in German.
- U 619 MESSYSID. Dreams answered. Working Messydis plus SID.
- U 621/4 C-MANUAL. Latest 4 disk C Manual by Anders Bjerin.
- U629/30 COMMSPLATION. 2 Disks packed with modem utilities.

## GAMES

- G 107 STAR TREK GAME Good graphic adventure, Best with 1 meg (2 disks)
- G 109 BLIZZARD Good horizontal Shoot 'em Up.
- G 133 PD GAMES COMPO Good selection inc Welltrix and Breakout.
- G 136 DRIP Very tricky painter type game. Almost commercial quality!
- G 137 THE TURN and TRICKY A couple of good puzzle games by Peter Handel.
- G 138 MARBLE SLIDE A cross between Pipemania and sliding blocks. Great!
- G 141 MAYHEM GAME FROM ENSIGNIA...Spaceship in caverns, tricky but addictive
- G 142 PD GAMES COMPO 3....Great Pacman plus 2 others.
- G 143 JEOPARDY (1 MEG)....Version of the board game Risk!
- G 152 PD GAMES COMPO 9....Battlemech, Bullrun (Battle Sim) and more
- G 154 BATTLEFORCE (1 MEG)....Strategy battle game.
- G 159 ANTEP (1 MEG)....RPG also SLOTS, a good car chase game.
- G 179 MEGABALL. The ultimate PD Breakout game?
- G 171 ZEUS Simple but addictive puzzle game. Great.
- G 175 CUBULUS. Great 'Rubics Cube' type puzzle. Excellent.
- G 178 WIZZY'S QUEST (1 MEG) Super game for PD. (Shareware).
- G 179 LLAMATRON By Jeff Minter, blast the beasts (Shareware).
- G 197 NBS GREAT GAMES VOL 3.... Super new games
- G 198 PATIENCE CARD GAMES....Superb games and graphics

## EDUCATION

- E 006/7 LEARN AND PLAY....Games plus maths and words (kids aged 5+)
- E 008 TALKING COLOURING BOOK....Draw the pictures then colour them

## FISH, T-BAG, AND GLAMOUR DISKS

We now hold all fish disks up to 500. The FISH AQUARIUM catalogue has been updated to include all the new disks. Although most of the programs are technical there are some great games and animations hidden away, we thoroughly recommend looking through the catalogue disk. We have all T-BAG disks up to 54.

**GLAMOUR DISKS:** We have an excellent collection of over 50 disks, demos and slides. Please remember you have to include a signed statement saying you are 18 or over to obtain these disks.

## AMOS

Please note all AMOS PD is £1.50 per disk. This is a selected list of the very best of the new AMOS Public Domain. All disks DO NOT require AMOS to run!!!

- A 102 (GAME) Chainsaw Death (1 MEG)
- A 103/4 (GAME) Pick Up A Puzzle (2 DISKS 1 MEG)
- A 105/6 (GAME) Picture It (2 DISKS, 1 MEG)
- A 109 (DEMO) Birds of Prey Picture Show
- A 110 (GAME) Cross Fire (1 MEG)
- A 115 (GAME) Balloonacy (1 MEG)
- A 123 (GAME) Deadline (1 MEG)
- A 124 (DEMO) Bob Maniacs by Syntex
- A 130 (GAME) The Wooden Ball (1 MEG)
- A 131 (DEMO) Armageddon Demo by Syntex (1 MEG)
- A 132 (UTIL) FAMILY HISTORY DATABASE (1 MEG)
- A 137 (GAME) Tile Trail
- A 135 (EDUC) Simon and Space Maths
- A 146 (GAME) Fruit Machine & Fruit Crush
- A 160 (QUIZ) Amos Quizmaster (1 MEG)
- A 162 (UTIL) Sound Samples 10. Clapping, creaks etc.
- A 166 (GAME) Pick-up a Puzzle Data Disk 2 (Needs A103)
- A 167 (GAME) Jigmania Data Disk. (Needs L013) (1MEG)
- A 176 (UTIL) Database Master (1 MEG)
- A 178 (GAME) Mastermind & Pair Up. (1 MEG)
- A 180/1 (GAME) Dungeon Delver. (2 Disks 1 MEG)
- A 182/3 (GAME) Pixie Kingdom (2 Disks 1 MEG)

## AMOS LICENCEWARE

All disks cost £3.50, which includes contribution to the programmer.

- L 001 (ART)\* Colouring Book (1 MEG)
- L 004 (GAME)\* Thingamajig (1 MEG)
- L 005 (GAME)\* Jungle Bungle (1 MEG)
- L 006 (GAME) Pukado (1 MEG)
- L 007 (GAME) 4 Way Lynx (1 MEG)
- L 008 (EDUC)\* Work and Play (1 MEG)
- L 009 (PROG) Amos Assembler
- L 010 (EDUC)\* The Word Factory (1 MEG)
- L 011 (GAME) Go-Getter (1 MEG)
- L 012 (GAME) Hypnotic Land (1 MEG)
- L 013 (GAME) Jigmania (1 MEG)
- L 014 (EDUC)\* Play It Safe (1 MEG)
- L 015 (GAME)\* Shapes and Colours (1 MEG)
- L 016 (GAME) Revers! 2 (1 MEG)
- L 017 (GAME) Dogfight (1 MEG)
- L 018 (GAME) Touchstone (1 MEG)
- L 019 (GAME) X IT 50 Excellent game (1 MEG)
- L 020 (UTIL) Wordy Word processor!
- L 021 (QUIZ) Quingo 3000 questions! (1 MEG)
- L 022 (UTIL) LC10 FONTS. Now supports LC200
- L 023 (GAME) ESP. Skill game
- L 024 (GAME) Shining Way of Kung fu. (1 Meg, 2 disks £5.50)
- L 025 (GAME) The Mission (1 Meg) Text adventure
- L 026 (GAME) Cyad (1 Meg) Great puzzle game

ALL LATEST AMOS LICENCEWARE NOW IN STOCK  
ALL DISKS MARKED \* ARE PRIMARILY WRITTEN FOR CHILDREN

## NBS COMMERCIAL SOFTWARE

As we now have a retail outlet we have a full range of software for ALL computers, plus blank disks, joysticks, cables, etc. Typically all software prices are 20% off RRP plus one free PD with games up to £10.00 and 2 up to £20.00 etc (Mail order only)  
Please ring for latest info.  
NBS provides the complete service!

## ORDERING DETAILS

PLEASE MAKE CHEQUES/PO PAYABLE TO NBS AND SEND TO: NBS, 1 CHAIN LANE, NEWPORT, ISLE OF WIGHT PO30 5QA.  
TELEPHONE (0983) 529594  
FAX (0983) 821599

Or if you have a Credit card you can phone or fax your order to us. Please remember to include 50p towards postage and packing to total order. All orders (up to 3kg) despatched by first class post, please add 30p for recorded delivery.

All used postage stamps donated to 'Guide Dogs for the Blind'

## WE LOVE INTERNATIONAL ORDERS

All orders sent by Air Mail. For European orders please add 25p per disk. World Orders add 50p per disk. International payments by Credit Card, British Postal Orders, Eurocheque, any cheque with a UK cashing address, or even cash (Registered letter).



PLEASE NOTE NEW PRICE FOR PUBLIC DOMAIN SOFTWARE



NBS PUBLIC DOMAIN .....£1.25  
AMOS PUBLIC DOMAIN DISKS ..£1.50  
AMOS LICENCEWARE .....£3.50

Price is per disk NOT per Title

PLEASE REMEMBER TO ADD 50P PER ORDER TOWARDS POSTAGE AND PACKING.

SPECIAL OFFER! TWO FREE DISKS FOR EVERY 10 ORDERED

SOME PEOPLE THINK RUNNING A PD LIBRARY IS A GAME, BUT ITS YOUR MONEY THEY'RE PLAYING WITH. DON'T TAKE A CHANCE, ADVANCE TO GO, WITH NBS.

NBS

NBS

NBS

NBS

NBS

NBS

NBS

NBS



# PD Update



PD is cheap, widely available software that can provide a viable alternative to commercial expense, but there's an awful lot to choose from. **Pat McDonald** picks out the best from this month's new releases.

## AMIGOIDS VIRUS FREE PD 1648



When things get hairy in *Amigoids*, use the shield to gain breathing space – spaceship intentionally left invisible!

Many moons ago, there was an arcade game called *Asteroids*. It featured line drawings in glorious black-and-white-o-Vision, it had you controlling a starship and blowing up lots of asteroids and aliens. The asteroids were shot into boulders, then into pebbles, and finally into nothing. Doesn't sound like much today, but back then it was state-of-the-art and the punters flocked to put their farthings in the slot.

This updated version makes full use of the Amiga's capabilities without changing the game at all. You play it with just a joystick (the original used keys), the sound is good, the graphics are in full colour and very smooth. The gameplay is just as fast as the original, if not faster. You can also play in two-player mode, which is good if both players are using the same joystick – a formation of two spaceships blasting and moving perfectly together.

I thought this sort of game had no hook any more. Fifteen minutes later on Level Ten I had extreme difficulty putting the joystick down. Simple, fast, noisy and dangerous, *Amigoids* is an arcade classic brought bang up to date without unnecessary frills. Excellent stuff, Marc Lafontaine!

## MULTIRIPPER 17 BIT 1080

What is a ripper, I hear you ask? It's a program which tries to rip useful old data from the Amiga's memory. When a program finishes or you reset the machine, a lot of information isn't wiped from the memory straight away. For nicking other people's samples, graphics, text or even *SoundTracker* modules they're extremely useful.

*MultiRipper* is the best I've seen, purely because it's simple. It doesn't have lots of flashy graphics or weird Copper effects, just good plain text telling you what pressing each key does – search for this, look for that, save it to disk and so on.

Also on the disk are two copiers. Both of them are up to the usual standard (they'll back up some disks, but not every disk) but they have a couple of unusual features. *RattleCopy* has a built-in game of *Pacman* – while you're waiting for a disk to be copied, you can have a quick run around a maze with the old manic muncher. Although the graphics are small, it's quite a good version of the old game – the mazes change every few levels.

The second copier is called *SanityCopy*. This doesn't have a built-in arcade game, but will password-encrypt disks so that you can only use them if you know the password. Although lacking any other feature of note, it's such a useful idea I had to mention it.



There have been copiers with built-in games, but *RattleCopy* is the only one with a *Pacman* inside it!

## BEGINNER BENCH VIRUS FREE PD 1654

*BB* version 1 was written by the Sundance Kid, and I must admit it's pretty good. All it really consists of is a set of utilities, but the way in which you use them is highly ingenious and yet ultra-simple.

A conventional Workbench screen loads, with an icon in the middle and a Shell window open. How do you use the programs? When you hold down the right mouse button, the usual menus appear: Workbench, Disk and Special. If you keep moving the mouse to the



If only all software were as easy to use as *Beginner Bench*. Just one press, hold, let go and you're there.

right, there are three more menus... The Utilities menu has a list of program names. These utilities can be loaded just by moving the mouse down so that the name highlights and then letting go of the mouse button. In addition to the usual *PowerPacker*, *DiskMaster*, *ScreenX* and so on, there are a couple I haven't come across before. *TaskX* gives a list of programs running, and lets you set the priority (to slow down 'hog' programs which insist on being more important for no good reason at all).

Of the other two menus, one consists of virus killers (nothing special, but you can never have too many of them) and the other will bring up the documentation files for the utilities. Like I said, very easy-to-use and highly inventive – I hope other collections of PD will use the system.

## DRAW MAP V2.3d PD SOFT V263

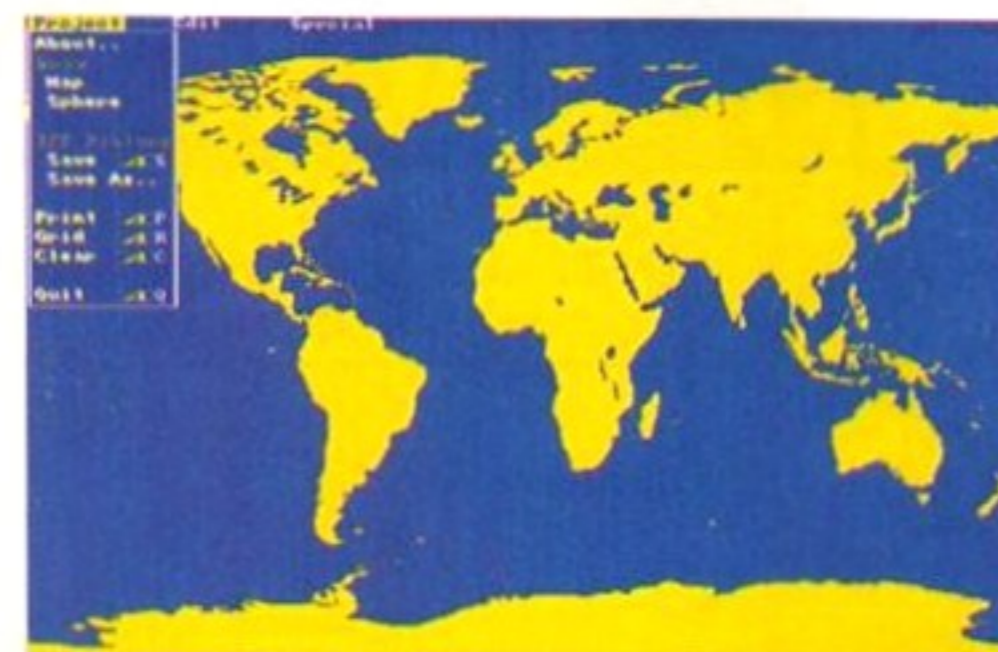

Ever wanted to use a map of the world, but couldn't draw it? Let *DrawMap* do the work for you!

*Draw Map* has been mentioned before in these pages, but this is a new release with a couple of bug fixes. It only draws one thing: maps of planet Earth, in high resolution using four colours (which you can change).

Why would you need this program? Well, for one thing the maps are proportionately scaled – you can magnify them without getting lots of jagged pixels. You can also wrap them around a globe, or have an orbital shot as seen from space, stars and all! Also, you can choose between normal and Mercator projection, and lay a grid pattern on top.

Still not interested? Well, if I said that you can save out the pictures in IFF to load into a paint program like *DeluxePaint IV*, you might get the idea. Maps are not easy to draw with a paint package on its own – they tend to look very inaccurate.

If you do your maps in *Draw Map* and then import them into other programs they look a lot better without taking ages to draw – it's pretty fast as well. Oh yes, and because the maps only use four colours (which you

# RIVERDENE PDL

30a, School Road, Tilehurst, Reading, Berkshire RG3 5AN

Tel: (0734) 452416 Fax: (0734) 451239

## DEMOS

AM587 Depeche Mode  
AM617 Fraxion Horror  
AM686 Sleeping Bag  
AM687 The Wall  
AM696 Budbrains II  
AM845 Spaced Out  
AM846 Hysteresis  
AM893 Global Trash  
AM894 Enigma  
AM895 System Violation

## ART

AM020 C-Light  
AM218 Nasa Slideshow  
AM401 Fractals  
AM456 Creep Show  
AM630 M-Cad  
AM631 Fast Cars  
AM702 Fillet The Fish  
AM705 Future Visions  
AM729 DBW Render  
AM847 Gorezone

## MUSIC

AM285 Samples  
AM342 Perfect Sound  
AM439 Module Rippers  
AM607 Beatles Music  
AM609 Med v3  
AM610 Synthia 2  
AM612 Bagpipe Music  
AM623 Soundtracker v4  
AM641 Pro Tracker  
AM843 Noise Player v2.4

## GAMES

AM155 Blizzard  
AM373 Quiz Master  
AM512 Tetrix  
AM579 Drip  
AM605 Bionix II  
AM626 Train Set  
AM899 Seven Tiles  
AM901 Cubulus  
AM906 Megaball  
AM933 Llamatron

**£1**

**PER  
DISK**

MINIMUM  
ORDER 5 DISKS

## UTILITIES

AM015 68000 Assembler  
AM087 Wordwright  
AM142 Spacewriter  
AM300 Quickbase  
AM384 Bank N  
AM459 Dope Intro Maker  
AM620 D-Copy  
AM621 ESA Utilities 1  
AM911 RSI Demo Creator  
AM931 C64 Emulator

PRICE INCLUDES 1st CLASS POSTAGE & PACKING (MINIMUM ORDER £5.00)

OFFER ENDS 30th SEPTEMBER 1991

## FREE PD CATALOGUE ON DISK

(please state Atari ST or Amiga)

when you send a blank disk and SAE to RIVERDENE PDL

ACCESS & VISA welcome

WHY NOT VISIT OUR SHOP?



## OFF THE WALL P.D.

Get your Graffiti  
off the walls and  
onto disk now!

We bring you everything you need to create  
your own superb demos:-

### R.S.I. DEMO MAKER

OFF THE WALL 30 page users manual  
enabling you to create demos in minutes

### T.S.B. VECTOR DESIGNER

MUSIC VOL 1 - Noisetracker hits including  
sampled sound tracks.

MUSIC VOL 2 - Includes Delta, Future,  
Soundmon Tracks.

R.S.I. UTILITIES DISK - Extra objects,  
logos etc.

Full package £7.00 inc P+P or  
£1.50 per item. Please state  
when ordering.

Tel: 0633 273494

### OUR TOP 10

241 R.S.I. - Demo Maker  
302 T.S.B. Vector Designer  
225 Simpsons "Decay" Version  
213 Essential Utilities 2  
237 Wonderland  
266 Budbrain 2  
265 Helloween 2  
237 Juggler II  
215 Essential Utilities 1  
187 Database Wizard

£1.50 per disk

Please write for our full list. S.A.E.

Cheques + Postal Orders to:-  
Off The Wall PD  
96 Magor Street, Newport  
Gwent NP9 06W

## LOAD CREST PD

1 - 9 DISKS £1.50 per disk 10 - 19 DISKS £1.25 per disk 20 + DISKS £1.00 per disk  
Post free in U.K. SAE for free printed list of titles.

D777 Phenomena Enigma  
D751 Bass Megademo II  
D834 Darkness Megademo 2  
U883/884 Astrology  
M866 Alcatraz More Than Music  
D993 More Stealthy Anims (1Meg)  
S870/871 Star Trek "Shore Leave"  
S/S (1 Meg)  
G759 Spectrum Emulator  
G861 Wizzy's Quest

M733 Zarch Music Collection III  
M724/725 Silents Blues House  
S571/572 Dr Who 'Ark In Space' S/S  
(1Meg)  
D752 Dexion Beyond Justic (1Meg)  
U518 R.S.I. Demo Maker  
M821/822 Astounding Sounds  
D833 Freehand Do The Bartman  
Remix (1 meg)  
D1357 Anti Lemmin' 2 Disk, 2 Meg

38 EASTBANK STREET, BOLTON, BL1 8LT ( Mail Order only)  
Tel (0204) 33367

A selection also available at:- SUDAMICROS, OLDHAM and BOLTON  
COMPUTER CENTRE, BOLTON.  
SOFTWARE SHOP, HORWICH.  
VUDATA, STOCKPORT.

# CENTRAL SCOTLAND'S PREMIER P.D. LIBRARY

### NEW ARRIVALS

U141 Jas Ultimate Virus Killers Gremlins 2 Slideshow (Exclusive)  
U138 Biorythms Demo U142 M.E.D. 3.11

### GAMES

G055 Battle Pong  
G059 Zeus The Game  
G058 Shapes  
G056 Attic Attack  
G057 Truckin on (2)  
G060 Empire  
G061 Airace  
G052 Megaball  
G048 Intact  
G045 Dragons Cave  
G035 Mayhem  
G034 Diplomacy \*  
G033 Quiz Master 2  
G027 Monopoly  
G024 Property Market Game  
G019 Drip  
G054 Space Blitz  
G001 Learn And Play (2)  
G007 Ten Game Compilation  
G008 Reichter Star Trek (2)  
G011 Castle Of Doom  
G003 Pipeline  
G012 Pseudo Cop

### UTILITIES

U152 M.E.D. Modules  
U151 Personal Address book  
U150 Personal Journal  
U149 Demo Creator/Space Writer  
U148 Printer Drivers  
U147 Dynamite fonts  
U146 Ham Lab  
U145 Golf Scorer

U144 Quickbench  
U143 Assassins Music Utilities  
U142 M.E.D 3.11  
U115 Mod To Executable  
U001 Workbench 2 Look A Like  
U103 Speccy Emulator  
U074 Business Utilities  
U039 Catalogue Workshop (2)  
U009 M-Cad  
U132 Jas Super Utilities  
U141 Jas Ultimate Virus Killers  
U133 Slideshow Creator  
U144 Amiga Tools 1  
U130 Amiga Tools 2  
U113 Deskbench (2)  
U044 Mac Clip Art  
U036 Icons  
U076 Education pack (5)  
U083 Ripped Modules (6)  
U080 Smovie Titler

### DEMOS/MUSIC/SLIDESHOWS.

D093 Prisoner Six Of One  
D091 Domestos Demo  
D090 Horror Show (2)  
D099 More Stealthy  
D088 Darkness Demo  
D084 Nemesis  
D076 Phenomena Enigma  
D082 Simpsons Decay  
D079 Newtrons 2  
M051 Led Zepplin Guitar Solos  
M053 War Of The World  
M052 Alcatraz Music Disk 1  
S030 Debbie Gibson Slides

S037 Star Trek Images  
S035 Fenn-Tastic 5  
S029 Naga Slideshow  
S022 Digitised Graffiti  
M016 Aliens Sounds (2)  
S011 Aliens Slideshow (2)  
M029 Iron Maiden (2)  
M015 Blues Brothers (3)

### AMOS PD

A052 Forms Unlimited  
A036 Archivist Database  
A021 Word Square Solver  
A003 Fonts Disk 1  
A004 Fonts Disk 2  
A005 Fonts Disk 3  
A115 Balooney  
A119 Electro-Cad Demo  
A132 Family History Database  
A142 Pair Crazy  
A123 Easy Street Game

### LICENCEWARE

Fletcher Fonts Pack 1  
Fletcher Fonts Pack 2  
L001 Space Blob  
L002 Mr Dig  
L003 Q-Boid  
L004 Computer Conflict  
L005 Sur Culture  
L007 Dizzy Lizzy  
L008 Lizzy Funtime (2)

\* = 1 Meg

We also stock other Fletcher fonts

### Fish Disks 1 - 495

### Amos Disks

1 - 240

### Amos

### Licenceware

1 - 25

### T-Bag 1 - 53

### Amicus 1 - 26

### SD Disks 1 - 40

### Prices

1-9 .....£1.25

10-19.£1.00

20+.....£0.89

We welcome  
international  
orders.

TEL: 0236  
737901

This is only a small selection of the hundreds of titles available from our constantly expanding library. Free  
disk catalogue sent with all orders. You can also call into our showroom and pick-up your software.

Payment by Access/Visa

or make your cheques or P.O.'s payable to

Office Choice:-

Suite 14, Avon House, Town Centre, Cumbernauld G67 1EJ



# C & N Computers Amiga Public Domain



354 High Street, Chatham, Kent. ME4 4NP. Orderline 0634-831870



## Music Section

- C006 Sonix No. 1
- C030 Share & enjoy equalizer
- C029 Sonix No. 7
- C043 Alf demo 1
- C061 Classix 1
- C066 Royal Amiga Force 1
- C067 Disk B to above
- C087 Kylie Its no secret
- C088 Disk B to above
- C093 Bacteria demo
- C101 Sonix classix
- C108 Digital concert 3
- C113 Sonix No.17
- C130 Budbrain demo 1
- C131 Disk B to above (18)
- C142 Digital concert 1
- C143 Digital concert 5
- C156 Donald weres yor trousers
- C163 Genesis Land of confusion
- C189 Treacl mega demo Disk A
- C190 Disk B to above
- C191 Disk C to above
- C192 Alkatraz demo disk A
- C193 Disk B to above
- C194 Disk C to above
- C198 Star trekking disk A 1 Meg
- C199 Disk B to above
- C200 Xmas carols
- C201 Good Morning Vietnam
- C210 Alf demo 2
- C229 Hot wired
- C236 Turtle demo by sector 16
- C244 Amazing Tunes disk A
- C245 Disk B to above
- C246 Disk C to above
- C248 Budbrain 2
- C303 Startracker V1.2
- C305 Sonix No.5
- C308 Zenn sound box
- C324 Noisetracker
- C327 Turtle power disk A
- C328 Disk B to above
- C329 Disk C to above
- C356 Beatmaster 808 state
- C367 Ultimate FX
- C380 Mucky Morris & the Cowpats
- C410 Digital Concert 2
- C411 Digital Concert 3
- C412 Digital Concert 6
- C416 Blues Brothers disk A
- C417 Disk B to above
- C418 Disk C to above
- C419 Dr Awesome & Fleshbrain
- C425 Arni sampled off radio Disk A
- C426 Disk B to above
- C428 Smith & Jones 1 (18)
- C429 Smith & Jones 2 (18)
- C430 Smith & Jones 3 (18)

All public domain disks are virus checked with the latest version of the Master virus killer. Anyone finding a virus on one of our disks please let us know and it will be removed from the disk.

## Amiga Public Domain Prices

Prices vary on how many disks are needed to make a program work. ie some music disks need 2 or more disks to work these are called sets.

Single disks £1.50 each  
Two disk sets £2.75 per 2 disk set  
Three disk sets £4.00 per 3 disk set  
Four disk sets per 4 disk set

### Min order 5 disks

More disks are in the collection, too many disks to list here. Last count over 900.

## Utility Section

- E001 SID
- E017 Printer utilities 1
- E020 Fonts disk 1
- E021 Fonts disk 2
- E022 Label designer
- E028 Ultimate utilities
- E029 Virus Killers disk 1
- E032 Boot block makers disk 1
- E034 Printer utilities 2
- E045 Business card maker
- E046 Viruscope (good)
- E051 Ncom V1.9 (modem util)
- E056 Tetracopy
- E057 Catalogue Workshop
- E063 C Manual
- E070 QL Emulator
- E071 Disk B to above
- E072 Disk C to above
- E074 Spreadsheet
- E083 Master virus killer
- E088 Textplus word processor
- E094 Flexi Wosname database
- E105 North C
- E114 Slideshow construction set
- E119 Dope intro maker
- E130 Rim database
- E140 A gene geneology program
- E141 Forms really unlimited
- E153 Disk crunchers

## Games

- D004 Monopoly USA version
- D008 Paranoid (Breakout game)
- D013 Peters Quest
- D020 Poker Solitaire
- D026 Blackjack/Solitaire
- D027 Star Trek disk A
- D028 Disk B to above
- D035 Break out games
- D044 Flashbier
- D052 The Drip
- D054 Breakout Construction Set
- D057 Letrix
- D065 Wet Beaver Tennis Game
- D069 Tiles/Battleships/Chess/Tetris II
- D070 Tomtespelet (2 player)
- D071 Return to Earth
- D072 Star Trek the Next Generation
- D074 UGA Games Computation
- D075 Snake Pit Game

## Graphics Section

- F011 Space Ace demo
- F015 3D Arm
- F025 Pugs in Space
- F030 Gymnast Amin 1 Meg
- F049 Fractal Flight demo
- F057 Viz Pics (18)
- F058 Fantasy Pictures disk A
- F059 Disk B to above
- F086 Enteprese leaves the Dock Anim 1 Meg
- F091 Stealthy Manoeuvres 1 Meg
- F097 Argatron Anims 07
- F098 Argatron Anims 24
- F100 Argatron Anims 02
- F101 Argatron Anims 22
- F102 Argatron Anims 23
- F104 Argatron Anims 17
- F109 Clip Art disk 1
- F110 Clip Art disk 2
- F111 Clip Art disk 3
- F112 Clip Art disk 4
- F113 Walker demo 1 2 Meg
- F114 Disk B to above
- F115 Walker demo 2 2 Meg
- F116 Disk B to above
- F125 Station Anim 2 Meg
- F126 Disk B to above
- F127 Disk C to above
- F141 Fillet the fish 1 Meg
- F164 Tobias richter slideshow
- F165 Disk B to above
- F166 Lost In Space Anim 2 Meg
- F167 Disk B to above
- F168 Disk C to above
- F170 Batman the movie 1 Meg
- F173 Juggler meets the lady
- F174 Fantasy space slideshow
- F176 Mandlebrot generator
- F179 Iraq demo 1 Meg
- F180 Amy the Squirrel at the Movies 2 Meg
- F190 Tron Anim 1 Meg
- F191 Disk B to above
- F200 Robin Hood slideshow with music (Cartoon)
- F209 Life of Brian slideshow with samples from film
- F219 Franklin the Fly anim
- F228 Italian Job digi Anim 1 1 Meg
- F229 Italian Job digi Anim 2 1 Meg
- F242 Stealthy Manoeuvres Swiss army F16 Anim

Directory disk £1.50 inc P&P. Contains some free PD utilities/music. Orders taken 24hrs a day on the answerphone payment via Access & Visa or mail order payment by postal order or cheque made payable to:  
**C & N COMPUTERS**  
Orders despatched within 24hrs (Mon-Sat). Phone orders despatched Mon if given on Sundays.

# BYTEBACK



# FAST

## DELIVERY SERVICE

...and the keenest prices

Ring us now! **0636-79097** we're programmed to help

## THE BEST OF THE PUBLIC DOMAIN

### DISK PRICES

- 1 disk .....£1.25
  - 10 disks + file box.....£9.99
  - additional disks.....99p
- (2D = 2nd Drive required)  
(Mb = 1 Megabyte required)

### GAMES

- AG.01 Star Trek; Superb strategy game. Digitised graphics! (2D-Mb-3 disks)
- AG.02 Various; Gravewars, Jackland, Pacman, Othello, Empire, Hanoi...
- AG.03 Star Trek (Agatron); Strategy game - Tobias Richter. (2D-Mb-2 disks)
- AG.04 Monopoly; full version of the classic property trading game!
- AG.05 Pacman 87; Multi level version of this addictive arcade classic.
- AG.06 Various; Cosmoroids, Amoeba, Crazy Eights, Blackjack, Backgammon, Daleks, Yahtzee, Stone Age etc...
- AG.07 Board and Card games; Cluedo, Othello, Klondike and Cribbage.
- AG.09 Puzzle Maker; Jigsaw puzzles from IFF files. Plus Puzzle Pro.
- AG.10 Space Invaders; Arcade Classic version! Plus: Lander, Amoeba...
- AG.11 Tennis; excellent shareware sports simulation (Mb)
- AG.14 Flascheiber; Boulderdash style game. Almost Commercial quality!
- AG.15 Paranoid game; Arkonoid style, including a screen designer.
- AG.16 Castle of Doom; Adventure game with graphics - beginners level.
- AG.17 ST Bash; Space Invaders style shoot-em-up, aliens are Atari ST's.
- AG.18 Golden Fleece; Infocom standard adventure. Plus: Tron; 2 Player Light cycle game. Train; Railway designer. Star Fleet, Kamikaze Chess etc...
- AG.22 Return to Earth; Elite style Space trading game, digitised sound.
- AG.24 Drip; Arcade quality game with digitised sounds and smooth sprites! Plus: China Challenge, Frogger etc.
- AG.26 Zerg; Ultima style Role Play. Plus: World; Infocom type adventure. Daleks, Callisto, Puz, Pontoon...
- AG.27 Star Trek (USA); Strategy game. Captain the Enterprise. (2D-Mb-2 disks)
- AG.28 Quattro; Tetris style. China Challenge; Shanghai style puzzle game Plus: Breaker and Asteroids.
- AG.29 Chess; Superb Multi Featured! Titles, Tetris Two, Battleships etc...
- AG.30 Twintris; Superb Shape dropping game! MUCH better than original!!!
- AG.31 Simpsons; vertical scrolling shoot-em-up style game! (SEUCK)
- AG.32 Legotris; another Tetris style game, amusing digitised sound effects
- AG.34 Tile Game; AMOS games creator variation on the old 16 puzzle.
- AG.35 Cave Runner; Commercial quality Boulderdash style game! Excellent!
- AG.36 Wizzys Quest; Professional quality arcade puzzle game.
- AG.37 Rings of Zon (Vol.1) Ultima style fantasy/strategy game...
- AG.38 Star Trek - Arcade game; SEUCK produced scrolling Shoot-Em-Up.
- AG.39 Wacko in Wonderland; Platform game with large Graphics! Cute!
- AG.40 Metagalactic Llamas; Classic Commodore 64 game by Jeff Minter!
- AG.41 Wet Beaver; Version of original tennis game with digitised sound (Mb)

### UTILITIES

- AU.01 Jazzbench; Workbench upgrade with many indispensable features!
- AU.02 UEdit; Excellent file editor, a vast improvement on Ed!
- AU.03 QL Emulator; plus 2 data disks packed with files. Superb! (3 disks)
- AU.04 Amiga Spell; Spelling checker, compatible with most Word Processors.
- AU.08 Various; Starchart: 600 stars & galaxies. TXED: editor/word processor.
- AU.09 Midi Tools; Midi Keyboard; Five octave, mouse operated keyboard... Prochange; change Midi channels etc.
- AU.10 Graphic utilities; Fontfixer, IFF Converter, Palette Converter... Boot utilities; Bootext, Bootup. Plus: Memcheck, Disksalv, Draggpack
- AU.11 Starchart; Astronomy program giving positions and movements of all major constellations!
- AU.13 Visicalc; Superb full featured Spreadsheet with manual on disk.
- AU.14 Various; Amcat; cataloguing system, Icontype; change Icon type, Recoverable RAMdisk, Spell Checker, Black Book, DX Synth voice library...
- AU.15 Dope Intro maker; Create Demos with this user friendly, package.
- AU.17 D Copy; Excellent disk copier similar to X Copy, Good Nibble model!
- AU.18 North C; Complete C Environment for the Amiga! Amazing value!
- AU.19 SID; Workbench replacement with easy file handling, improved DMouse window control and many more features
- AU.20 K.O. The Virus; Virus detectors and killers! Includes; Virus X 4.1
- AU.21 Avoiding CLI; Lots of useful utilities otherwise only obtainable through CLI; FixDisk, QuickCopy...
- AU.22 Text Plus; Word Processor (v2.2) Very professional program with many commercial quality features!
- AU.23 Word Wright; Word Processor. Plus: Amiga Spell; Spell checker!
- AU.24 Spectrum Emulator; Run some Spectrum games on your Amiga!
- AU.26 Complete C Manual; packed with info on C programming, 11 chapters plus 70 executable examples! (3 disks)
- AU.27 Amibase (v3.76); Professional quality, multi-featured database program... Recommended!

### CLIP ART

- AC.01 Deluxe Paint; lots of quality pictures in low, medium & high res.
- AC.02 Pagesetter Art; Animals, Food, Computers, Fantasy, Holidays...
- AC.04 IFF Alphabets; 30+ screens of character sets and surfaces...
- AC.05 Animals, Anatomy, Buildings, Christmas, Construction...
- AC.06 Cartoons; Comic pictures of people, animals, funny objects...
- AC.07 Holidays, Home, Flags, Flowers, Miscellaneous...
- AC.08 Music, People, Places, School, Religion, Symbols, Weddings...
- AC.09 Signs; Titles, Logos, Headings, Athletics, Bowling, Boxing, Football, Cricket, Racing, Fishing, Horses...
- AC.10 Teddy Bears; ideal for Present Labels, Greetings Cards etc... Plus: Silhouettes; lots of shadow pictures.
- AC.11 Nightclub, Vintage Cars, Bikes. Computers, Boats, Office, Industrial.
- AC.12 Colour; Occasions, Transport, Signs, Electrical, Architecture...

### SOUNDTRACKER

- SND.01 Soundtracker; Four versions of this favourite Music creation program.
- SND.02 Soundtracker 4; alternative version + instruments disk. (2 disks)
- SND.03 Sound Monitor; 20 Demo scores + instructions in this superb sound package! Extra RAM and Drive useful. Plus: Instruments disk. (2 disks)
- SND.04 MED Music Editor; Soundtracker style music creator! Easy to use!
- SND.05 Soundtracker 8 Track; Superb! Plus converter for 4 track files...
- STI.01 to STI.08 Digital Soundtracker samples! 8 disks packed with 100's of files! (Buy one or all 8 for £7.99)
- STS.01 Sampled sound effects to use instead of instruments!
- STS.02 Longer samples, many from films, Star Wars, 2001, Raiders...

### EDUCATIONAL

- AE.01 Blackboard Maths, Concentration Colourpad, Cat & Mouse, Galactic Worm Animated Pointers, Shark... (Age 5+)
- AE.02 Spellquiz, Wheel of Fortune, Tug 'o' Word, Flower Garden, Stepping Stones, Maths Test, Puppypix (Age 5+)
- AE.03 Fractals, Desktop Calculator, Function Plotter, Evolution (Age 11+)
- AE.04 Gravitywell, Weatherman, Gravsim, Airfoil... (Age 11+)
- AE.05 World data Bank; CIA world map with political boundaries, view from anywhere, any height! Plus: 3D Plot, Calendar Factory, Sherlock (Age 11+)
- AE.06 Talking Spelling Tutor, Speech Toy, German Language Test, Study File, Card System, Globe, Elements, Geotime, Text Utilities (2 disks) (Age 11+)
- AE.07 Educational graphics; Technical illustrations; Biology, Astronomy etc. Some animated (eg. pumping heart) Includes viewing programs. Or load into Deluxe Paint etc. (Age 9+)

### FONTS

- AF.01 Cosmopolitan; Rangers, Peignat, Avant Guard, Aidous, Celtic etc...
- AF.02 Fancy; Hollywood, Park Avenue, Broadway, Camelot, Courier, Ham...
- AF.03 Publishers; Helvetica, Akashi, Andover, Bookman, Boxie, Times...
- AF.04 Various; Unusual, Videofonts, Large & Small fonts... Utilities.

### WORKBENCH

- AW.03 Icons; Music, Ram, Naughty, Jet Icons. Plus: Utilities, Colourbench Icon Development; Design Icons with Deluxe Paint! Examples included!
- AW.04

### SLIDESHOWS

- AS.01 Boris Vallejo 1; Professional quality graphics in interlaced HAM!
- AS.05 Exodus Real 3D show; 9 very impressive Ray traced pictures.
- AS.06 Swimsuits; Great pictures from the U.S. Sports Illustrated mag.
- AS.12 M.C. Escher; Animated slideshow of Eschers paradoxical artwork...
- AS.20 Slideshow Construction; Pictures scroll up/down, fade in/out! etc...
- AS.21 Fantasy; Stunning full screen pictures and superb soundtrack!
- AS.22 Viz; Digitised pictures from the wonderful Viz magazine.
- AS.23 Agatron Slideshow 10; Ray Traced pictures of Star Trek ships including shots from T. Richters impending video

### HELP!

- AH.01 Adventure Game Solutions; More than 100 including: Dungeon Master, Future Wars, Ultima 1 to 5, Sierra, Infocom, Bards Tale, Zak MacKracken, Maniac Mansion, Rainbird... Every Adventure players dream! (2 disks)

### DEMOS

- AD.01 Walker 1; Digitised animation of Star Wars Imperial Walker (Mb)
- AD.02 Walker 2; Digitised animation of Walker and helicopter! (Mb)
- AD.04 Probe Sequence; Incoming video pictures from an interstellar probe landing on an alien planet! Amazing!
- AD.13 Walking Cat; Amazing Revolving digitised animation of walking cat!
- AD.16 Ghost Pool; Animation of a pool game with invisible players!
- AD.18 Puggs in Space; Amusing cartoon of alien creature exploring Earth!
- AD.21 Busy Bee; Amazing Sculpt 3D animation of a large flying Bee! (Mb)
- AD.22 Democreators. Create your own demo's with; Bootwriter, Bootmaker, Bootboy, Boot generator etc...
- AD.23 Ship and Sphere; Ray Trace film of space ship and glass sphere. (Mb)
- AD.24 NewTek Demo Reel 3; Incredible professional demo of NewTek product range features superb sampled sounds, digitised animations... (Mb-2 disks)
- AD.25 The Run; 3D film of Lotus chase through traffic with police car! (Mb)
- AD.28 Stamp Collector; Animation of magnifying glass and naughty stamps!
- AD.29 Predators Megademo; Brilliant demos including 2 games! (2 disks)
- AD.32 Vision Megademo IV; Superb Digitised music and sound effects!
- AD.36 Kefrens Megademo VIII; 10 demos including; Kill the Beast (Shadow of the Beast meets Xenon 2)... (2 disks)
- AD.39 Agatron animations; 3D film of USS Enterprise attacking USS Reliant.
- AD.40 Luxor Teenager; Variation on the classic with 2 anglepoise lamps!
- AD.41 RGB; Badgkiller competition winner! Produced with Director! (Mb)
- AD.42 Comic on a disk; whole graphic novel, page by page, on screen!
- AD.44 Laurel and Hardy; Digitised clips from various films! (2 disks)
- AD.45 Star Trek, Dry Dock demo; The highly praised Ray Trace masterpiece!
- AD.46 Stealthy Manoeuvre II; Cartoon style Stealth Fighter animation.
- AD.47 Walker Demo; The incredible 2 Megabyte animation (2Mb - 2 disks)
- AD.48 Amy V Walker; Amy the Squirrel chases AT-AT with Monkey Wrench! (Mb)
- AD.49 Budbrain Productions; Quality animations including Movie! (2 disks)
- AD.50 Budbrain Demo 2; Great sound, great graphics, another classic!
- AD.51 Fishtank demo; Animation of sea creatures miming in time to music!
- AD.52 Popeye meets Beach Boys; Very amusing singing combination...
- AD.53 Iraq demo; Mini film involving Saddam Hussain and John Major!
- AD.54 Simpsons; Digitised: Do the Bartman plus great Bart slideshow!

To order any of the above disks simply quote the required disk numbers. For a complete list of our PD software ask for a FREE catalogue!

## TOP QUALITY DISKS - BY RETURN OF POST!

# BYTEBACK

DEPT AF, 6 MUMBY CLOSE, NEWARK, NOTTS, NG24 1JE

Cheque, postal orders or credit card facilities are available



# BYTEBACK



# FAST

## DELIVERY SERVICE

...and the keenest prices

Ring us now! **0636-79097** we're programmed to help

### GUARANTEED RETURN OF POST DELIVERY ON ALL STOCK ITEMS

#### GAMES

Action Stations	21.99
Armalyte	17.99
Armour-Geddon	17.99
Atomino	17.99
Awesome (PLUS T-Shirt)	24.99
Back to the Future 3	16.99
Bards Tale III	16.99
B.A.T.	19.99
Battle Command	16.99
Battle of Britain	19.99
Billiards Simulator	19.99
Bill & Teds Excellent Adv	17.99
Captive	15.99
Cardinal of the Kremlin	17.99
Charge of Light Brigade	19.99
Car-Vup	16.99
Champion of the Raj	17.99
Chaos Strikes Back (Mb)	16.99
Chase HQ 2	16.99
Chessmaster 2100	19.99
Colditz	19.99
Conquest of Camelot	24.99
Cricket	19.99
Crystals of Arborea	17.99
Curse of the Azure Bonds	19.99
Cybercon III	17.99
Demoniak	20.99
Deuterios	21.99
Disk	17.99

**FREE - PUBLIC DOMAIN DISK!**  
with any game from this column!

Dragon Breed	16.99
Dragonstrike	19.99
Dragons Lair II - Timewarp	24.99
Dungeon Master	16.99
Elvira	19.99
Exterminator	16.99
Eye of the Beholder	21.99
Feudal Lords	16.99
Frenetic	17.99
Flames of Freedom (Mid 2)	21.99
Flight of the Intruder	19.99
Gem X	17.99
Genghis Khan (Mb)	22.99
GODS	16.99
Golden Axe	16.99
Gunboat	20.99
Halls of Montezuma	17.99
Hard Drivin' 2	16.99
Jahangir Khan Squash	17.99
Kick Off 2 (Mb)	15.99
Lemmings	17.99
Life and Death (Mb)	15.99
Lotus Esprit Turbo	16.99
Merchant Colony	19.99
MIG 29	24.99
Mighty Bombjack	16.99
Moonbase	23.99
NAM 1965 - 1975	19.99
Navy Seals	16.99
M1 Tank Platoon	19.99
PGA Tour Golf	18.99
Pool of Radiance	19.99
Powermonger	18.99
Predator 2	17.99
Pro Tennis Tour 2	16.99
Railroad Tycoon	23.99
Renegade Legion - Interceptor	22.99
Rick Dangerous 2	16.99
Rorkes Drift	15.99
Revelation	14.99
Secret of Monkey Island	19.99

#### GAMES

Shadow of the Beast 2	24.99
Shadow Dancer	17.99
Sim City + Populous!	19.99
Speedball 2	16.99
Spirit of Excalibur (Mb)	21.99
Stormball	17.99
Supercars 2	16.99
Super Monaco Grand Prix	17.99
Supremacy	19.99
Switchblade II	17.99
S.W.I.V.	16.99
Team Suzuki	16.99
Toki	17.99
Turrican 2	16.99
U.M.S. 2	19.99
Ultima V	22.99
Warlords	19.99
War Zone	14.99
White Sharks	17.99
Wings (Mb)	18.99
Wrath of the Demon	19.99
Wreckers	17.99
Z-Out	14.99
3D Pool	8.99

#### COMPILATIONS

<b>PHANTASIE - BONUS EDITION</b>	<b>19.99</b>
Phantasie, Phantasie III and Questron II.	
<b>PREMIER COLLECTION</b>	<b>18.99</b>
Last Ninja, Flimbos Quest, Int Karate +, Tusker.	

#### TOP SHOTS

Kick Off and Extra Time!	6.99
--------------------------	------

#### MONSTER PACK

Shadow of the Beast, Infestation, Nitro.	19.99
--	-------

#### LEISURESUIT LARRY TRIPLE

Leisuresuit Larry 1, 2, & 3.	34.99
------------------------------	-------

#### WINNING TEAM

Cyberball, Klax, Vindicators, Planet of Robot Monsters, Klax.	21.99
---	-------

#### POWER UP

Rainbow Islands, Altered Beast, Chase HQ, Turrican, APB.	21.99
--	-------

#### FISTS OF FURY

Double Dragon II, Shinobi, Ninja Warriors, Dynamite Dux.	19.99
--	-------

#### MASTER MIX

Thunderblade, Turbo Outrun, Crack Down, Super Wonder Boy, Dynamite Dux.	16.99
---	-------

#### WHEELS OF FIRE

Hard Drivin, Power Drift, Turbo Outrun, Chase HQ.	12.99
---	-------

#### SPORTING GOLD

Games Winter Edition, Games Summer Edition, California Games.	19.99
---	-------

#### HOLLYWOOD COLLECTION

Ghostbusters II, Robocop, Batman (Movie), Indiana Jones.	19.99
--	-------

#### PLATINUM

Ghouls and Ghosts, Strider, Black Tiger, Forgotten Worlds.	17.99
--	-------

#### POWER PACK

Xenon II, TV Sports Football, Bloodwych, Lombard RAC Rally!	16.99
---	-------

#### PREMIER COLLECTION III

Archipelagos, Quadralien, Cybernoid 2, Battleships.	12.99
---	-------

#### EXTRA MEMORY

500K RAM Expansion	29.99
--------------------	-------

**PLUS: 10 FREE PD disks!**

#### AMOS

AMOS - Games Creator	34.99
AMOS - Compiler	19.99

#### AMOS Licenceware

Each	3.50
------	------

#### LPD.01 Colouring Book; Fun for kids.

#### LPD.02 Arc Angel Maths; Educational.

#### LPD.04 Thingamajig; Jigsaw puzzles.

#### LPD.05 Jungle Bungle; Adventure (Mb)

#### LPD.06 Pukadu; game. PLUS; Sprites 600, use in your own AMOS programs!

#### LPD.07 4-Way Lynx; Puzzle game (Mb)

#### LPD.08 Work & Play; 3 Educational games for children. Very good! (Mb)

#### LPD.09 AMOS Assembler; (needs AMOS)

#### LPD.10 Word Factory; Educational childrens programs. (Mb preferred)

#### LPD.11 Go-Getter; Original game (Mb)

#### LPD.12 Hypnotic Lands; Puzzle game.

#### LPD.13 Jigmania; Jigsaw fun (Mb)

#### LPD.14 Play it Safe; Educational (Mb)

#### LPD.15 A.A. Shapes; Fun for kids (Mb)

#### LPD.16 Reversi 2; Classic game (Mb)

#### LPD.17 Dogfight 2; Arcade game (Mb)

#### LPD.18 Touchstones; Board game (Mb)

#### LPD.19 X-IT-50; Original game (Mb)

#### LPD.20 Wordy; Word Processor! Good!

#### LPD.21 Quingo; Trivia Quiz (Mb)

#### LPD.22 LC10 Fonts; Plus Font design!

#### LPD.23 E.S.P.; Original Arcade game.

#### LPD.24 Shining Way of Kung Fu; with digitised graphics! (2 disks - Mb)

#### LPD.25 Mission; Text adventure game.

#### LPD.26 C.Y.A.D.; Puzzle game (Mb)

#### DISKS 100% Guaranteed!

Bulk disks (10)	4.49
Plus (50)	20.99
Labels (100)	39.99
KAO or (500)	169.99
SONY (1000)	329.99

#### SONY Boxed (10)

#### Plus (50)

#### Labels (100)

#### 8.99 42.99 79.99

#### SALE \* SALE \* SALE

Archipelagos	4.99
Battle Squadron	9.99
Colossus Chess X	9.99
Centrefold Squares	7.99
Deluxe Strip Poker	7.99

#### Dxe. St. Poker + Cent. Sqs

	12.99
--	-------

#### Daily Double Horse Racing

#### Dragons Breath

#### ELITE

#### Galaxy Force

#### Mouse Trap

#### Netherworld

#### Rick Dangerous

#### Shadow of the Beast

#### Silent Service

#### X-OUT

#### 8.99 9.99 12.99 9.99 2.99 4.99 8.99 12.99 9.99 9.99

#### JOYSTICKS

#### Joystick & Mouse Extension

#### Quickshot III Python

#### Quickjoy III Supercharger

#### Quickjoy Jetfighter

#### Quickjoy TOPSTAR

#### Competition Pro Extra

#### Sting Ray Handheld

#### Zip Stick Professional

#### 4.99 9.99 11.99 12.99 19.99 15.99 13.99 15.99

#### ART AND DESIGN

3D Construction Kit	32.99
Deluxe Paint (3)	59.99
Director (2)	79.99
Disney Animation Studio	79.99
Fantavision	29.99
Icon Paint	14.99
Image 3D	174.99
Photon Paint	19.99
Pixmate	39.99
Professional Draw (2)	99.99
Real Things - Birds 1 & 2	23.99
Real Things - Humans	23.99
Real Things - Horses	19.99
Spectra Colour	54.99
The Art Department	54.99
X-Cad Designer	89.99

#### Podscat 12 x 12 Tablet

	179.99
--	--------

#### Podscat Drivers

	22.99
--	-------

#### Colourburst Tablet

	519.99
--	--------

#### Pandaal Hand Scanner

	159.99
--	--------

#### JX100 Scanner

	579.99
--	--------

#### Scanlab Software for above

	69.99
--	-------

#### VIDEO

#### Broadcast Titler

	199.99
--	--------

#### Deluxe Video III

	59.99
--	-------

#### Digiview GOLD (4)

	129.99
--	--------

#### G2 Broadcast Videocentre

	549.99
--	--------

#### HBM Genlock

	149.99
--	--------

#### Home Titler

	29.99
--	-------

#### MiniGen

	104.99
--	--------

#### Panasonic WV1410 Video Camera (including lens)

	229.99
--	--------

#### RGB Splitter

	64.99
--	-------

#### TV Show (NEW)

	54.99
--	-------

#### Video Titler 3D (NEW 1.5)

	79.99
--	-------

#### Vidi Amiga

	119.99
--	--------

#### Vidi Colour Solution

	169.99
--	--------

#### MUSIC

#### Audio Master (3)

	54.99
--	-------

#### Audio Engineer Plus

	169.99
--	--------

#### AMAS

	79.99
--	-------

#### Deluxe Music Con. Set

	49.99
--	-------

#### Dr. T Copyist Apprentice

	69.99
--	-------

#### Mastersound

	29.99
--	-------

#### Midi Master (Hardware)

	34.99
--	-------

#### Music X (1.1)

	99.99
--	-------

#### Music X Junior

	49.99
--	-------

#### Perfect Sound

	49.99
--	-------

#### Quartet

	34.99
--	-------

#### BUSINESS

#### Cashbook

	39.99
--	-------

#### Day by Day

	22.99
--	-------

#### DG Calc

	27.99
--	-------

#### Final Accounts

	22.99
--	-------

#### Home Accounts

--	--

**P. D. DISK PRICES      DEMOS & ANIMATIONS      MUSIC DISKS      UTILITIES DISKS      GAMES DISKS**

1 - 9 disks = £1.25 each  
10 or more = £1.00 each

**POSTAGE FREE**  
if you live in the U.K.  
Europe add £2.50 to order  
Rest of World add £4.00

**PLEASE NOTE:**  
2 disk sets are charged as  
2 single disks, 3 disk sets  
as 3 single disks, etc.

**TELEPHONE ORDERS**  
may be made using any  
Visa, Access or Mastercard  
on  
**(0709) 829286**  
**MINIMUM ORDER £3.00**

**CATALOGUE DISK**  
**PRICE 50p**  
with contents and comments  
on the disks in our library  
plus on-disk goodies!

**ABBREVIATIONS USED**  
\* = 1 meg needed  
(X) = 18 and over only  
(please state age)  
Figures in brackets refer  
to number of disks in set.

- 016 Space Ace Demo
- 085 Red Sector Megademo (2)
- 089 Gymnast Animation \*
- 107 RAF Megademo (2)
- 157 Cool Cougar Animation \*
- 161 Kylie Minogue Demo (2)
- 240 Puggs in Space Cartoon
- 280 Tree Frog Animation \*
- 288 The AMOS Demo
- 399 NewTek Demo 3 (2) \*
- 483 Elvira Demo
- 646 Predators Megademo (2)
- 744 Red Sector Cebit Demo
- 747 Popeye Meets Beachboys
- 773 Shark Animation \*
- 825 Budbrain Megademo (X)(2)
- 853 Dragons Lair Demo \*
- 854 Bread/Home & Away Demo
- 865 Coma Demo
- 895 Trip To Mars
- 897 Scoopex Mental Hangover
- 906 Madonna Cartoon \*
- 954 Teenage Turtles Demo
- 964 Operation Vark!
- 1001 Station at Khern \*\* (3)
- 1033 At the Movies Anim \*\*
- 1034 Stealthy 1 Animation \*
- 1093 DPaint 3 Demo (2) \*
- 1105 Crionics Neverwhere Demo
- 1110 Fractal Flight
- 1188 Fillet The Fish
- 1200 Raiders of Lost Ark Anim \*
- 1229 Budbrain 2
- 1235 Kickboxer Demo
- 1238 Evil Dead Demo (X) \*
- 1246 LSD: Comix Disk 1
- 1256 Killing Game Show Demo
- 1271 Legend of Billy The Kid \*
- 1280 Horizon: Sleeping Bag
- 1287 Wrath of the Demon Demo

- 052 Awesome Sounds
- 061 J M Jarre - Definitive
- 166 Vangelis \*
- 187 Crusaders Audio X
- 407 CD Player Demo\*
- 409 Crusaders: Freakd Out!
- 497 Amiga Chart 5
- 552 Music Invasion 3 (2)
- 654 Powerlords Power Musix 2
- 713 Flash! - Queen (2)
- 724 Technotronic Remix
- 746 Crusaders Bacteria
- 824 Digital Concert V
- 866 Pan III Music Disk
- 914 Special Brothers Music 2
- 935 Madonna: Hanky Panky
- 941 Soundtracker Jukebox
- 969 100 C64 Games Tunes
- 970 The Comic Strip Remix
- 976 Scoopex: Beast Sonix
- 982 E & L: Get Up!
- 986 Amaze : Revolutions
- 993 PSA Music Demodisk 1
- 1026 Digital Concert VI
- 1107 Stop Right Now! \*
- 1243 Chip Music Festival
- 1248 LSD: Supreme Music 1
- 1284 Cave: Synthetic Power
- 1292 Crusaders Does Genesis
- 1630 Accession: Sun Wind
- 1685 Depeche Mode Music Disk
- 1694 Art of MED Music Disk
- 1695 Seal: Crazy Remix \*
- 1755 Amazing Tunes 2 (3) \*
- 1763 Aamond Gallant Knight (3)\*
- 1772 Taipan Music Disk (2)
- 1776 Crusaders: Sheet Music
- 1777 Beatmasters:Technology
- 1787 Magnetic Beats 2
- 1788 Magnetic Beats 3

- 051 Visicalc Spreadsheet
- 081 UEdit Word Processor
- 110 Disk Utilities
- 111 Grafix Utilities 1
- 118 Grafix Utilities 2
- 119 Amiga MCAD
- 180 Pagesetter Clip Art
- 210 Icons!
- 259 Ultimate Bootblock Coll. (2)
- 343 Intromaker
- 346 TV Graphics (2)
- 348 APDC 25 (Programming)
- 353 ShoWiz 2.0
- 354 PowerPacker 2.2a
- 410 DPaint Cartoon Brushes
- 442 DPaint Fonts Disks (4)
- 456 Chet Solace Extravaganza
- 458 HAM Radio Special (5)
- 495 ClickDOS (CLI Helper)
- 516 A68k Assembler/C Compiler
- 536 Red Devil Compacting Util.
- 546 Iconmanial
- 571 Jazzbench
- 580 Dope Intro Maker
- 591 Business Card Maker
- 595 Amateur Radio Disk
- 632 MessyDOS
- 633 Analyticalc
- 642 C Manual
- 643 SID v1.06
- 661 Programming Disk
- 682 Sound Applications (2)
- 684 Video Applications (2)
- 697 Graphics Management (2)
- 901 THE Comms Disk
- 902 QED Text Editor
- 1022 AMOS/RAMOS Update 1.21
- 1023 Future Composer
- 1058 Zero Virus V3.0
- 1071 Noiseplayer V3.0

- 117 Monopoly
- 135 Classic Board/Card Games
- 195 Electric Train Set
- 251 Blizzard
- 314 Breakout Construction Set
- 315 Return to Earth
- 496 Holy Grail Adventure \*
- 648 Star Trek (USA) (2) \*
- 680 Learn & Play (2)
- 727 Star Trek (Richter) (2)
- 957 Pipeline
- 962 Dripl
- 987 Snakepit
- 991 Jeopard \*
- 1004 Games Disk 9
- 1230 Dragon Cave
- 1245 Rings of Zon \*
- 1408 A59: Super Quiz
- 1411 A62: Arcadia
- 1510 Pick Up A Puzzle (2) \*
- 1512 Picture It (2) \*
- 1517 A110: Crossfire \*
- 1520 A115: Balloonacy
- 1528 A130: Wooden Ball \*
- 1531 Simon Says/Space Maths
- 1532 A137: Tile Trial \*
- 1533 The Jar \*
- 1539 Megaball \*
- 1544 Seven Tiles
- 1558 Adventure Solutions (2)
- 1573 A142: Pair Crazy
- 1577 A146: Fruit Machine \*
- 1579 A148: Demolition Mission \*
- 1580 A149: Gobbet / Pontoon \*
- 1584 A153: Missile Command
- 1591 A160: Quizmaster \*
- 1608 A178: Mastermind/Pair Up \*
- 1610 A180: Dungeon Delver (2)
- 1612 A182: Pixie Kingdom (2)
- 1614 A184: Towers of Hanoi
- 1668 Tomtespelet
- 1670 Wheel of Fortune
- 1690 Hints Disk One
- 1700 Terror Limer 2 (X)
- 1711 Mental Image Games One
- 1715 Frantic Freddie
- 1720 Cabaret Asteroids
- 1746 Word Games Volume 1 \*
- 1747 Word Games Volume 2 \*
- 1748 Startegy Games \*
- 1749 Truckin' (2)(2 drives) \*
- 1780 Arcade Game Cheats 1
- 1781 Serene II

**WE ALSO STOCK**  
**FRED FISH DISKS**  
**AMOS P.D. DISKS**  
**T.B.A.G. DISKS.**  
**&**  
**AMIGOS DISKS**  
**ASK FOR THEM**  
**BY NAME!**

**NEW LOWER PRICES! OVER 1,800 DISKS!**

# Crazy Joe's

**DEPT. AF9, 145 EFFINGHAM ST., ROTHERHAM, S. YORKS. S65 1BL**

**P. D. PACKS      DEMOS & ANIMATIONS      SLIDESHOWS      UTILITIES DISKS      ACCESSORIES**

**8 disks for £8**  
A great way for new Amiga owners to check out what p.d. is all about. Each pack contains 8 disks and is just **£8 per pack!**

**GAMES PACK**  
37 Titles on 8 disks including Asteroids, Tiles, Bally 2, Sys, Pool, YachtC, Invaders, H-Ball, Fruit Machine, Block Off, Shoot Out, Peter's Quest, and many more!

**DEMOS PACK**  
Some of the most popular demos in the library: Coma, Wild Copper, Cebit 90, Elvira, Mental Hangover, Rebels Megademo 2, Pain Is Just The Beginning, and Popeye Meets The Beachboys!

**SOUNDTRACKER SPECIAL**  
The great PD music maker, plus instruments, songs, modules, rippers and more! Make music or just have fun!

**HOME BUSINESS PACK**  
A suite of programmes for those who want to dabble in the serious side: Nag, Bank'n, Journal, QBase, Spread, Wordwright, AmigaSpell, Inventory, MemoPad & more!

- 1400 A51: Weird Science
- 1453 More Aerotoons \*
- 1474 System Violation Demo \*
- 1477 Ecstasy Demos \*
- 1507 A100: AMOS Demo 2
- 1516 A109: Weird Science 2
- 1518 Panthorus Megademo (2) \*
- 1524 A124: Bob Maniacs \*
- 1525 A125: Benson Demo 2 \*
- 1529 Armageddon Demo \*
- 1540 Amy .vs. Walker Anim. \*
- 1541 Batman Animation \*
- 1542 Pogo Anim (1.5 meg)
- 1548 Jochen Hippel Sound Demo
- 1551 Too Much 3D \*
- 1552 Magician Anim V2.0 \*
- 1553 Steve's Anim Disk 1
- 1554 Steve's Anim Disk 2
- 1555 Steve's Anim Disk 3
- 1556 Steve's Anim Disk 4
- 1557 Steve's Anim Finale Disk
- 1560 Phenomena Enigma Demo \*
- 1586 A155: Panthorus Demo 2
- 1598 A168: Curos & Stauros (2)
- 1628 "Do The Bart, Man" Demo \*
- 1650 Crionics: Total Destruction \*
- 1664 Silents: Blue House (2) \*
- 1667 More Classy Animations
- 1692 Basketball Animation \*
- 1701 Tron Animation (2) \*
- 1703 Total Respray
- 1704 Total Recount
- 1705 Total Restyle
- 1706 Total Retrieal
- 1707 Decay: Simpsons Demo \*
- 1753 Life of Brian (2)
- 1774 Magnetic Fields Demos 90 \*
- 1775 Total Confusion \*

- 078 Vallejo Fantasy Art (2)
- 163 NASA Slideshow
- 167 Digiview Slideshow
- 171 Patrick Nagel Pictures
- 185 Escher Slideshow
- 238 TV Sports Basketball
- 282 Forgotten Realms
- 617 Neighbours Slideshow
- 725 Diggy Piggys Slideshow (2)
- 742 Madonna Slideshow
- 767 Cinemaware Slideshow
- 814 Viz Slideshow
- 831 Utopia Cartoon Slideshow
- 891 Creepshow
- 899 Madonna Slideshow 2 (2) \*
- 942 Garfield Slideshow
- 968 Gorezone Slideshow (X)
- 1051 Total Recall Slideshow
- 1062 Golems Gate Slideshow
- 1073 Fraxion Fantasy Slideshow
- 1085 Comic Slideshow (X)
- 1103 Girls of Sports Illustrated
- 1210 Turtles Slideshow
- 1272 Nemesis: Prologue
- 1277 Fraxion: Divine Visions (2) \*
- 1279 Forgotten Realms '90
- 1475 Nemesis: Chapter 1 (2) \*
- 1480 The Age of Slack
- 1523 A121: Nik Williams Demo
- 1546 Skywalker Digishow 1
- 1547 Skywalker Digishow 2
- 1549 DPaint Colour-Cycled Pics
- 1561 Demons Slideshow 3 \*
- 1666 Mages Staff
- 1693 WWF Slideshow
- 1708 Invisible World Slideshow
- 1719 Yabba Dabba Cartoons
- 1781 Reflections Slideshow

- 1095 Catalogue Workshop (2)
- 1097 DTP Clip Art (2)
- 1099 Video Graphics (4)
- 1117 Genealogy \*
- 1198 Soundtracker V4.0 (2)
- 1222 Picture Format Convertors
- 1225 Hardware Projects Mag
- 1228 ST Emulator
- 1234 Tetra-Copy
- 1253 Red Devil Utilities 5
- 1255 Opti Utilities 1
- 1265 Cryptic Utilities 17
- 1273 C-Light
- 1274 Star Trekker 1.2 Music Prog.
- 1286 Mandelbrot Generator 1.85 \*
- 1294 Chaos & Fractal Programs
- 1360 DKB Trace (Fish 397)
- 1366 Fix Disk (Fish 403)
- 1383 Menu Writer (Fish 420)
- 1385 Art of Virus Killing
- 1432 A83: AMOS Paint
- 1450 New SuperKillers Disk
- 1451 ElectroCAD
- 1452 AmiBase
- 1473 ARP 1.3
- 1534 MED V3.0
- 1535 Master Virus Killer V2.0
- 1536 North C V1.3 (packed)
- 1537 North C V1.3 (unpacked)(2)
- 1543 Quantum Tool Disk 12
- 1545 SpectraPaint V3.0
- 1550 FlexiBase V2.0
- 1569 A138: Spanish Tutor
- 1587 A156: Rippers Disk
- 1606 A176: Database Master V2.0
- 1629 ZX Spectrum Emulator
- 1663 Dynamite Cut & Paste Fonts
- 1778 Stolen Data Magazine #5

**3.5" BLANK DISKS**  
**10 FOR £4.99**  
WITH DISK BOX £5.99  
**50 FOR £22.50**  
WITH DISK BOX £26.50  
**100 FOR £39.99**  
WITH DISK BOX £44.99

**DISK BOXES**  
**FLIP-TOP**  
10 capacity . . . . £1.49  
**LOCKABLE**  
40 capacity . . . . £4.99  
50 capacity . . . . £6.99  
80 capacity . . . . £7.99  
100 capacity . . . . £9.99

**MISCELLANEOUS**  
Mouse Mat . . . . . £2.99  
Keyboard Cover . . . . £2.99  
Monitor Cover . . . . . £5.99  
Printer Cover . . . . . £4.99  
Mouse House . . . . . £1.99  
Drive Cleaning Kit . . . £2.99  
Printer Cable . . . . . £6.99  
Stereo Leads (2m) . . . £2.99  
Stereo Leads (5m) . . . £3.99  
VHS Library Cases  
£6.99 for 10

**"CRAZY JOE'S" LOGO**  
**T-SHIRTS (M / L / XL)**  
White . . . £3.99  
**SWEAT SHIRTS (M / L / XL)**  
White . . . £8.99  
(PLEASE STATE SIZE)

can change, he points out again) then that leaves you lots more colours for your pictures. Right on, Bryan Brown and Ulrich Denker. A shame the documentation is in German, but all the same it's quite easy to get the result you want.

## WORD FRENZY

### 17 BIT 1068



**QuickBase is ideal for keeping track of your nearest and dearest. And the bank manager, and the poll tax office...**

So, you have a PD text editor. What do you do for a spelling checker or simple database? You buy this disk, of course! This disk has one of the most easy-to-use databases I have ever come across. *QuickBase*, by Kevin Harris, uses just one screen with lots of colours and large text for easy reading. It's very simple and good for storing names and addresses for mailing lists, and it's an absolute cinch to use.

*AmigaSpell* (from Mike Berro) has one or two annoying quirks for a spelling checker program. The dictionary is virtually empty, so you'll spend a lot of time at first teaching it the correct spelling of words. It also can't find the same mistake twice while checking, so if you consistently misspell it's not very good. The good thing about it is the actual checking procedure – the best I've ever seen.

After *AmigaSpell* has analysed a text file for errors, it scrolls the whole file from left to right across the screen. Any errors are highlighted – you can make the program learn them or ignore them. Because you can see the words on either side, you know whether or not the word is the wrong one because it's out of context – for example, "Look over their".

XSpell lacks the good and bad points of *AmigaSpell* – again, you'll spend a while teaching it new words. However, if you register it (send a donation to Hayes Hodgen, the programmer) he will send you a 40,000 word dictionary plus a new version with an Undo command – after all, we all hit the wrong key from time to time.

The Manager series from Hal Carter is on there as well. This includes *MailManager*, *HouseHold* and *Reference Manager* (a card database) all share the same basic layout, but differ as to what they can store. However they are looking a wee bit long in the tooth now – they date from 1986!

## GOLF RECORDER V1.6



**Although of minority interest, Golf Recorder version 1.6 is very well programmed, looks nice and is easy to use.**

## AMIGANUTS 1093

Would you like to keep all of your golf scores on your Amiga? Well then look no further, because this program has been custom written to help you do just that. It will happily keep track of your course averages as well as your match play.

Using this demo is pretty easy. First, you have to tell it about the course that you want to keep records for: how long the whole course is, the pars of each hole and the length, and the scratch score (the average score for the course).

It may sound dull as ditchwater, but there are a couple of noteworthy features. For one thing, the program is very well error-trapped – if you type in a number that's a bit silly (a par one hole, or a course that's 200 yards long) then the program brings up a message saying it doesn't believe you. You can override this and have some pretty weird score cards, but more often than not you won't because most golf players like to keep honest averages.

The other factor is that all the options are controlled by clicking with the mouse – there are no menus to hunt for the correct option. You can print out the scores, of course, if you have a printer.

What really impressed me were the digitised images of professionals mixed in with the program. It's a cheap trick to jazz it up, but perfectly valid. Why don't more serious programs try to be light-hearted, rather than plain and boring? Thank you Peter Wilson.

## TSB VECTOR DESIGNER

### UNIQUE COMPUTING UT-107

The Special Brothers, Ivan and Alloc, have been working hard on this extremely interesting vector designer. If you have seen a few demos, you'll know what a vector is: a two or three-dimensional shape with straight edges that can be spun, moved, coloured and generally whizzed around the screen.

Being public domain, it's not exactly *Sculpt 4D*. There's not much on-screen help and the text used by the program is a bit too small for easy reading. Having said that, it's extremely quick – with a bit of practice you can bang out vectors quickly.

A few other points to mention are that the on-disk documentation is pretty thorough and is written in fairly reasonable English. Also included is an example demo, showing off just what you can do. The best thing is that the program can save vectors out in a form which is suitable for use with the Red Sector demo maker, for extremely fast and unprofessional-looking results (by unprofessional I mean of the best PD standards – don't take it personally, it's a joke aimed at professional programmers).

## PCQED

### AMIGANUTS 1113

PCQ is one of the few versions of the Pascal computer language available on the Amiga, and is certainly one of the cheapest. Many educational establishments use Pascal or the similar Modula-2 for teaching how to program. The name, incidentally, is just the initials of the programmer, Patrick Quaid.

One of the problems with PCQ is that it's just a compiler – usually you have to buy another disk for the linker and use a text editor (from another PD disk unless you have a word processor that can save in ASCII). Mark Meany has been working away to put a few bits together on just one disk.

Happily, this disk is all you need. It contains all the programs, the environment is waiting for you as soon as the disk has booted and it's a convenient way to start programming in Pascal. OK, so maybe it's nothing new, but I'm all in favour of hassle-free PD. The documentation is reasonable enough for a beginner in the language, and overall it's worth getting if you need to use the language as a part of your studies.

## CYAD

### AMOS PD LPD26 (1Mb needed)

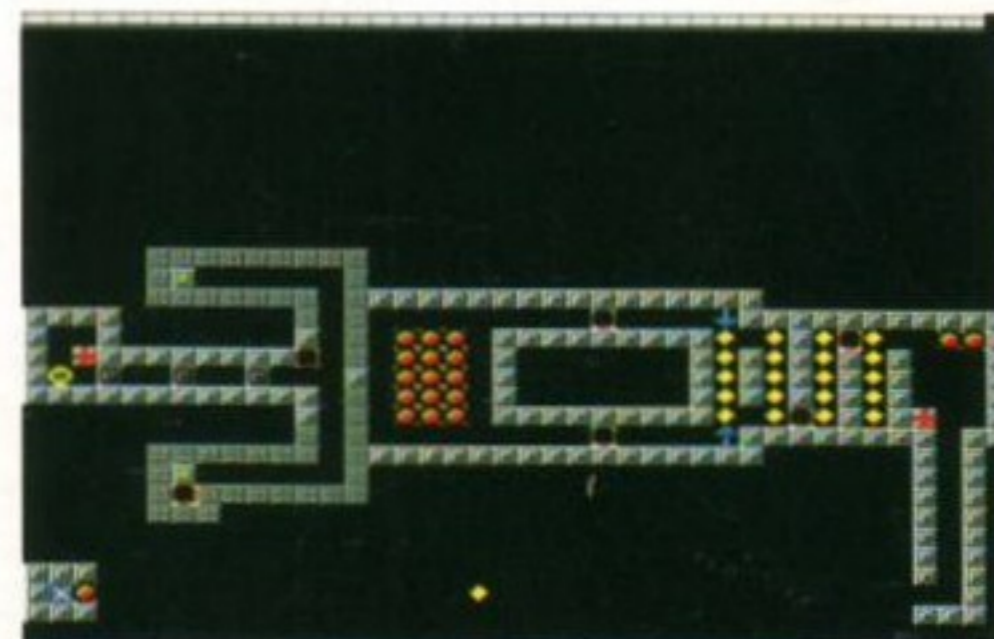

**Cyad starts off looking pretty easy, but by the time you get to this third level you realise it's going to take quite a while to suss out each screen...**

If you've read the feature on AMOS and its new additions on Page 114-117, you might like to check out what it can do: and what better way than with this excellent little game.

Jamez Newcombe is a fan of JM Jarre and it shows in the sweet little soundtrack, while the game itself is very similar to *The Power*. You control a little yellow creature who whizzes along until he is stopped by a wall. It starts looking easy, but a few levels in the puzzles get wicked. Hours of brain-bending fun follow!

## CONTACT LIST:

17 BIT, PO Box 97, Wakefield, West Yorkshire, WF1 1XX, 0924 366982

AMIGANUTS, 169 Dale Valley Road, Hollybrook, Southampton, SO1 6QX, 0703 785680

PD SOFT, 1 Bryant Avenue, Southend-on-Sea, Essex, SS1 2YD, 0702 612259

UNIQUE COMPUTING, 114 Salters Road, Gosforth, Newcastle upon Tyne, NE3 3UP, 091 284 7976

VIRUS FREE PD 23 Elborough Road, Moredon, Swindon Wilts SN2 2LS

AMOS PD 0942 495261

## PD TOP TEN UTILITIES

### LOW ALCOHOL PUBLIC DOMAIN

- 1) ProTracker V1.1
- 2) Demon Games Vol 6
- 3) ZeroVirus III
- 4) Three Player Tetris
- 5) European Charts disk
- 6) Tobias Richter Star Trek
- 7) Kefrens Utilities 4
- 8) Messydos
- 9) WellTrix
- 10) MCP V0.9

# Amiga Mouse



1400 catalogued disks

Utilities, Soundtracker modules/instruments  
art & design, games, demos etc etc.

Free updated catalogue disk sent with orders

Buy 10 PD disks and choose one free.

A small selection from our vast list:

## GAMES

Games 029 7 Titles  
Games 031 Battleforce  
Games 032 Return to Earth  
Games 033 Megaball

## UTILS

Util 067 Ultimate Virus Killer  
Util 012 Wordwright + Lots  
more  
Util 079 Red Sector Demo  
Creator  
Util 052 Pascal Compiler

## ANIMATIONS

Anim 036 The Stamp  
Collector  
Anim 037 Juggler II  
Anim 030 Vaux Killer  
1.5 Meg 3 Disks  
Anim-031 Upgrade  
1.5 Meg 6 Disks

Send 70p for Catalogue Disk.

Fast Reliable Service

£1.00 per disk 50p Post & Packing

£2.50 Europe

# Amiga Mouse

182a High Street, Margate, Kent.

Tel: 0843-228166

Credit cards accepted with orders over £10



# EdLib

The new concept in PD/Shareware

The EdLib collection - a carefully chosen selection of PD, compiled by subject to save you time, trouble and money. All disks regularly updated with the latest and best programs. Full of hints, tips and tutorials. Membership available. Unbeatable value: only £1.50 per disk!

**Flying Start:** To get you going on your new Amiga.

**Best Utilities:** The best utilities around for the new user.

**Graphics Master 1 & 2:** Why buy expensive commercial software? Convert resolutions, HAM, map images on spheres and shapes and much more. (2 disks).

**The Compleat Iconiser:** Everything you need to create ANY icon.

**SPECIAL STARTER PACK:** The above 5 disks for only £5.00

**Animator's Delight:** Animate to your heart's delight. (2 disks).

**C Disks:** Learn C without tears - a very thoughtfully designed presentation. (2 disks).

**Best Mandelbrot:** Extraordinary Mandelbrot programs all in one package.

**Fractal Laboratory 1:** A comprehensive suite of programs for exploring just about every aspect of fractals. (Fractal Laboratory 2 now also out).

**Scientific Collection 1:** PD Astronomy - for starry-eyed stargazers.

**HobbyHorse:** Family entertainment - music, puzzles, even garden design.

**All Systems Go!** Guide to Amiga operating system - save £££'s on books.

**Our Favourite Games:** Sys, Drip, Welltrix, 3 exceptional games on one disk.

**Cellular Automata:** Game of Life, Life 3D + many more.

**Also:** Super Utilities, SillyBench, ARP Library, Basic Compiler, PC-HAM conversions, PC-Disk Reader, CanDoDecks, Fully Working Prolog (2 disks).

**NOW ALSO OUT:** Science 2 - more astronomy and gravity \* Science 3 - chemistry \* Science 4 - Making Waves (physics) \* Workbench Logic Games - a collection of fully multitasking games, to keep you distracted from serious work for hours!

See our catalogue for the full list of EdLib compilations.

Large stock of other PD disks - only 89p! \* ALL the Fish disks 1 - 470

F190 Moria adventure \* F205 Chess - The best \* F283 marble Slide \* F285 Rubik \* F300 Scrolling Title Gen \* F338 SID 1.6 \* F397 DKB Ray Tracer \* F424 Turbo Titler - Subtitling \* F444 China Challenge \* F465 Text Plus (simple) & F415 UEdit (advanced) word processors \* F453 Lemmings Demo \* F456/7 updated Amiga C tutorial \* F421 Rings of Zon

A48+49 - Laurel & Hardy \* A10a+b - NASA pics \* A47 - Amy vs Walker

A14 Juggler/Juggette II - wicked new twist to the old classic demo\*

D3 Budbrain 2 \* D4 Dragons demo \* D8 Phenomena - Enigma \*

U23 Simpson Decay demo \* M34 Popeye meets Beach Boys \*

G1 Seven Tiles - Speedball clone \* P108 Master Virus Killer \*

P111 Red Sector demo creator \* P142 8 - Colour WorkBench + 300 icons \*

P144 Med 3.11 - LATEST & BEST: if you want to make Amiga music, get this! \*



Loads more: Catalogue disk available for £1.00 incl p&p (or 50p with order).

High quality disks, all virus-free and copied with verify flag.

UK customers add 60p p & p per order. European customers add £1.00, or £2.50 for registered. Rest of the world, add £1.60, or £3.60 for registered.

Cheques/Postal Orders/International M.O.'s to:  
EdLib (Dept AF2), Scotland Farm, Stockwood Road,  
Brislington, Bristol BS4 5LU. Tel: 0272 723489

ALL DISKS  
STILL ONLY  
99p EACH

# Anglia PD

NEW! - ANGLIA "PLUS" PACKS. The ultimate in PD software giving you the convenience of a commercial package at a PD price. Each "PLUS" pack includes the highest quality PD programs together with full printed instructions presented in an impressive folder. The first "PLUS" pack to be released is The Business "PLUS" Pack which contains 5 disks covering a complete range of business software and over thirty pages of instructions.

The complete package costs just £7.95...More "PLUS" packs to be released soon, phone for details.

**BUSINESS PACK 5 DISKS £4.95**  
Text-Plus v2.2E (Word pro), 4 databases including RIM, Clerk (accounts), Spreadsheet, MCAD (graphics), + 2 Spellcheckers.

**DESKTOP VIDEO PACK 4 DISKS £3.96**  
Outstanding collection for video producers, includes Rolling Credits, Slideshow, Video Backgrounds, Special Effects, Pattern Generator and more!!!

**PROGRAMMERS PACK 5 DISKS £4.95**  
Forth, Modula 2, Lisp, Logo, Pascal, North C v1.3 + C Manual disk.

**HARD DISK PACK 3 DISKS £2.97**  
Sid v1.06, HD Utilities, Easy Backup, Password, View 80.

**BEGINNERS PACK 4 DISKS £3.96**  
CLI Tutorial, Quick Copy, E.S.A. Utilities, Disk Master v3.0.

**CLIPART PACKS 1, 2 + 3 5 DISKS £4.95**  
3 different packs of 5 disks, all full of the very best clipart for DPaint etc.

**FONTS PACK 1, 2 + 3 5 DISKS £4.95**  
3 different packs of 5 disks, pack 1 contains: Publisher fonts, various fonts, fonts disk 2, Cosmopolitan fonts, large fonts (loads of great fonts for DPaint etc.)

**NEW! ANGLIA COLOURFONTS 5 DISKS £4.95**  
Contains 5 disks full of original colourfonts produced here at Anglia, ideal for captions, titles, etc. Use with DPaint III.

**ADVENTURE PACKS 1 + 2 5 DISKS £4.95**  
Pack 1: Holy Grail, Golden Fleece, Castle of Doom, Return to Earth, World, Colossal, Adventure Writer. Pack 2: Dragon Cave, Moria, Rings of Zon, Imperium Romanum, Larn v1.2.

**CARD & BOARD GAMES 4 DISKS £3.96**  
Cluedo, Cribbage, Monopoly (English version!), Mastermind and much more!

**PUZZLES PACK 2 DISKS £1.98**  
Puzzle Pro (jigsaw game), Wordsearch.

**CLASSIC GAMES 5 DISKS £4.95**  
Pacman, Space Invaders, Slot Cars, Flashbier (Boulderdash Clone), Missile Command.

**ULTRA GAMES PACK 5 DISKS £4.95**  
Seven Tiles, Balloonacy, Mayhem, Battleforce, Arcadia. (All of these games have received rave reviews from Amiga magazines).

**GAMES PACK 1 5 DISKS £4.95**  
Blizzard, China Challenge, Escape from Iovi, Paranoid, Moonbase and Drip! (Probably best game in PD).

**UTILITIES PACKS 1, 2, 3 + 4 5 DISKS £4.95**  
4 different packs with all the utils you will ever need! Pack 1 contains: Chet Solace disk (26 utils), Diskmaster v3.0, Darkstar Utilities 2, 3 & 4.

**ADULTS PACK 1 5 DISKS £4.95**  
5 disks full of "animations". 18 and over only.

**ADULTS PACK 2, 3 + 4 5 DISKS £4.95**  
3 different packs of five disks full of "slideshows". 18 and over only.

**EDUCATION PACK 1 5 DISKS £4.95**  
German, Globe, Geotime, Drawmap, Evolution, Clouds, Formula, Airfoil, Gravity Sim, Weather, Wave Maker, World Data Bank and more!! (This pack is one of our best sellers and is incredible value for money).

Please note all pack disks may be bought singly at 99p!

SINGLE DISKS AT ONLY 99p!

**BUSINESS**  
B301 Bankn (Home Accounts)  
B302 MessyDOS + CrossDOS (Read + write MSDOS)  
B303 Flexibase (Database)  
B304 Wordwright (Word processor)  
B305 Viscical (Spreadsheet)  
B306 U-Edit (Great word processor)  
B307 Journal (Good home accounts)

**UTILITIES**  
U401 Power Packer 2.3B  
U402 Master Virus Killer v2.1  
U458 Freud (Take the test!)  
U404 A-Gen v1.5 (Family Tree)  
U405 ST + C64 Emulators + MessyDOS  
U406 Jazzbench (upgraded Workbench)  
U407 WB2 (Workbench v2.0 lookalike)  
U413 Sid v1.6 (makes you a master of CLI)  
U438 Spectrum Emulator (with programs)

U465 Antiflicker (eases high-res flicker)  
U463 Multiplot (excellent graph plotter)  
U472 Commis disk (total modem control)  
U461 Cryptic utils (inc. Diskmaster)

**GAMES**  
G620 Pipeline (commercial quality)  
G659 Turn + Tricky  
G632 Tennis  
G602 Megaball  
G603 The Jar  
G605 Wooden Ball  
G607 T. Richter Star Trek (2 disks)  
G641 Star Trek (3 disks)  
G640 Frantic Freddie  
G642 Marble Slide  
G651 Eat Mine  
G652 Dynamite Dick  
G664 Yelp!  
G663 Sealance (new sub game)  
G662 Boing the Game (2)  
G655 Crossword Creator  
G660 Wordsquare Solver

**CHILDRENS**  
C701 Learn + Play (2 disks)  
C702 Train Set  
C703 Talking Colouring Book  
C704 Simon Says/Space Maths  
C705 Treasure Island  
C706 Snakes + Ladders  
C707 Pair It

**GRAPHICS**  
GR801 C-Light (Ray trace)  
GR802 DKB Trace (Ray trace)  
GR803 Slide Show Construction Kit  
GR819 Amos Paint (v. good paint prog.)  
GR805 Mandelbrot Generator v1.85  
GR821 Spectrapaint (serious DPaint rival)  
GR807 Graphics Utilities Disk  
GR826 Anglia Digifonts (superb digitised fonts)

**MUSIC**  
M901 Med v3.0  
M902 Sound Tracker Pro  
M903 14 Sample disks for above  
M919 Kefrens Jukebox  
M920 Future Composer



**PUBLIC DOMAIN SOFTWARE**

ANGLIA PUBLIC DOMAIN LIBRARY  
Anglia House, 115 Ranelagh Road, Felixstowe, Suffolk, IP11 7HU

**TELEPHONE 0394 283 494**



Simply phone your order through or send a cheque/postal order. Please add 60p to cover post and packing.





PDSOFT.(AF26), 1 BRYANT AVENUE, SOUTHEND-ON-SEA, ESSEX, SS1 2YD.



**CREDIT CARD HOTLINES**  
(0702) 466933/612259



**UTILITIES FROM OUR FAMOUS VARIOUS COLLECTION**

Our various disk collection are all UnArked, AutoBooting & Ready to go.

**V002 CLIP ART COLLECTION PACK** Eight disks packed with Page Setter ART WORK (8) Excellent

**V013 PLAY & READ EDUCATIONAL:** Black Board maths & various other programs. Ages Under 5

**V017 VC** The calculator spreadsheet There is more than one program on this disk. **Visicalc**

**V020 RAYTRACER** Excellent program to allow you to generate ray tracing images. Very Nice

**V023 APPOINTMENT CALENDAR: NAG** is an electronic appointment calendar.

**V024 BANKN** Will allow you to keep your bank account in perfect balance with ease.

**V027 QUICKBASE** A Mailbase Management utility. Keep a record of all your friends

**V028 SPELLCHECKER** Current glossary contains 9,000 words. More can be added

**V029 HOUSEHOLD INVENTORY** Provides the means of maintaining HH possessions

**V041 DPAINT ART** Contains loads of pics for to mess around with. also use with DTP

**V048 TV GRAPHICS & VIDEO GRAPHICS** Various Utilities for Video Production (8)

**V085 RED SECTOR INC DEMO CREATOR** This is the best Demo creator Program disk

**V086 VIDEO PRODUCTION (2)** Both Packed with Various video & genlock utils

**V090 D COPY & TETRACOPY** Another two disk copiers with excellent improvements.

**V108 AMIBASE V3.76** This is the Most popular Amiga Database. Very good disk

**V109 PRINT STUDIO** Excellent for printing picture or text. Printer users need this disk

**V123 RIM: LARGE DATABASE PROGRAM**

**V131 C - LIGHT** This is the most well known ray tracing program to date & is very simple to use.

**V132 (ST-15) PSYGNOSIS INSTRUMENTS** for use with any music program (samples)

**V134 PAGESETTER CLIP ART V1.9 & V2.0 (2)** Another collection of excellent clip art to use.

**V147 JR - COMM: MODEM PROGRAM**

**V156 NEW PAGESETTER CLIP ART (3)**

**V159 THE VIRUS KILLER COLLECTION II**

**V166 THE C MANUAL** These disks contain over 70 Fully executable examples. (3 Disks)

**V169 THE RIPPED MODULES COLLECTION** The Disks are full with Music & Samples (10)

**V179 CLOUD & FRACTAL PROGRAMS** Various Fractal Generating utilities. Good starting disk.

**V191 MASTER VIRUS KILLER** Virus Checker and Killer with an Excellent Search option. The Best.

**V193 THE EMULATORS** Covers various Formats which includes CBM, IBM - PC & ST (IBM & ST Programs requires two drives) **IBM Em is 2 disks**

**V194 MR BACKUP HD** An excellent Hard disk backup program & utilities for your hard disks.

**V195 GRAPHIC INTERCHANGE** Change Between Atari ST/PC Graphics to the Amiga. In GIF Format.

**V210 ARP (V1.3) WBI.3.2** Install this prog to speed up your Workbenches operations. (V37)

**V213 (ST-2) HOUSE MUSIC INSTRUMENTS Vol II** The Samples have Remixed back. More samples

**V214 STARTREKKER VERSION V1.3** This is a sound tracker like program, But much better.

**V215 DISK MASTER V3.2** Copies files from one disk to another. **DISKSALV** Corrects disk errors. Disk recommended for Hard Disk users.

**V216 SPECTRUM EMULATOR VERSION 1.0** Includes Games including loads of old classics.

**V218 VIRUS MURDERER & ZERO VIRUS V2.01,** Kills & Protects all of your disks. Virus killers.

**V232 FRACTAL CREATOR VERSION V1.2** Another excellent Generating Prog with new features.

**V256 THE SILENTS** Present: Some of the best Amiga music modules. Highly Recommended!

**V259 MED v3.10** Brand new version which includes Med songs & a New Med Player (2)

**V261 TEXT PLUS VERSION 3.0**  
This disk is not just an update but, a completely New Program. This disk come highly recommended.

**V262 NEW DISK COPIERS:** Super Duper, Turbo copy, Sanity copy & P Copy. All New updated vers

**V263 DRAWMAP3D** Generate flat Globes, Orbital & Mercator Pictures of the Earth. New Education

**V264 PD - Soft VOL8: VIRUS KILLERS,** Big Brother, Berserker, Zero Virus & No Virus. All Updated vers

**V266 FLETCHER UTLS VOL1: CONVMACF** Convert Mac fonts to the Amiga. **POST** Post Script Interpreter Program & **REDAKYU.** All Excellent Programs

**V267 FRACTALS V2.1** Fractal Generator that generates many various different Styles

**V268 AMIGA ADVENTURE** Write Your own Text adventures & swap with your friends

**V269 BUSSINESS: PENNYWISE ACCOUNTS** A CashBook control Program for the Amiga.

**V270 PRINTER DRIVERS UPDATE DISK** Contains over 80 Drivers, Inc Canon BJ Citizen 24 Swift Colour & Mono & A Printer Driver Generator prog.

**V271 MEGAFONT PROGRAM** Program to create Text fonts. Source on Fred Fish Version 2.7 (2)

**V273 FRACTAL CONSTRUCTION SET** used to generate iterated fractals, like Sierpinski & more.

**V274 DICE C SYSTEM (2)** Dillons Integrated Environment system. V2.06.15 Which includes a compiler, assembler, linker & support libs (FF466)

**V276 DISKPRINT V2.7** Prints labels for 3.5 disks. Primarily for small PD Library disks. Excellent.

**V277 FORTRAN - 77 V1.3c** Compiler, linker & run time support library. ANSI compatible. Fred Fish 470

**V278 MANDEL PANG** MandelBrot Plotter. This is the latest updated version with some new features

**V279 CROSSWORD CREATOR** A program that creates crossword puzzles. this is version 3.3

**V280 BUDGET** A program to help with managing personal finances. This is Version 1.302 (New vers)

**V281 MAND ANIM V1.2** New MandelBrot animation program which is easy to use.

**V284 BUSSINESS: MCAD PROGRAM** The Object Drawing Program for the Amiga. ie CAD program

**V285 EDUCATIONAL: TYPING TUTOR A** Simple tutor which measures your typing speed.

**V286 DKB RAY TRACING PROGRAM** New Tracer with excellent Effects, this is very complex (3)

**V289 SMAN MANDALBROT** Another new updated Fractal generating program. Very nice result

**V291 POSTSCRIPT INTERPRETER V1.5** The Software based Post script interpreter. (1Mb)

**V292 CHEQUE BOOK ACCOUNTANT V.09** Excellent way to keep track of your Cheques

**V293 NCOMM** The only communication package you will need if. Excellent Modem Program

**V294 ED'S MED MUSIC MODULES** Theres various music modules for use with MED. All new modules

**V295 C64 EMULATOR** Helps to assist C64 users upgrading to the Amiga. Full 64 basic

**V296 PUZZLES** Four different variations of word puzzle games. By Russell Mason.

**V298 NORTH C V1.3 (2)** Unpacked Version

**V301 EYE OF THE BEHOLDER HINT BOOK** Includes Maps, Strategy, Hints & Solution.

**V302 MAVERICK COPIER:** The best amiga copier to date. See your games/programs copyright notice before using this product.

**V303 CROSSDOS v4.02A** New updated version. trans Pc to Amiga or St to Amiga. (Asc Text files)

**V304 CHAOS STRIKES BACK HINT BOOK** Includes Maps, Strategy, Hints & Solution.

**V306 A-GENEV3.125** Latest version of the Family Tree program. Genealogy program

**V307 VIDEO TAPE DATABASE PROGRAM** Catalogue all your video tapes, for future reference

**V311 JACK NICKIUS COURSE DISKS** Various New courses for the Golf Game (5)

**V316 MEAN 18 COURSE DISKS** Various New courses for the Excellent Mean 18 Golf Game (2)

**V318 PRO SOUND TRACKER V1.1B** The Latest & best version of this excellent Music program.

**V319 SOUND TRACKER V2.6** Another Update of the famous Music program. New features.

**V320 THE AMOS UPDATE V1.3** The latest update for all you who use the program. (More Amos)

**V321 UEDIT** Another excellent Word processor with loads of extra features. Easy to use version.

New versions are released all the time. When you place an order you will always receive the most upto date version in stock.

**GAMES & AMOS**

Our Game disks are all AutoBooting, UnArked & Ready to Play.

**0982 MONOPOLY & CLUEDO GAMES**

**1244 MISSILE COMMAND** Fred Fish F444

**1247 RINGS OF ZON** Gauntlet style (\*)

**1248 DRAGONS CAVE** Excellent Game

**1254 STAR TREK** The Shoot Em up game

**1255 THE SIMPSONS** Control BART

**1259 TWINTRIS** Two people can play

**1328 WHEEL OF FORTUNE** One of the best Quiz's. As the series on Television.

**1335 WIZZY'S QUEST** Excellent Game

**1341 DOWN HILL SKIING** Arcade Game

**1367 BLACKJACK** The Casino Simulator.

**1370 HACKLITE** Dungeons & Dragons

**1374 TENNIS** Excellent Tennis Simulator

**1420 DTRIS** Played Tetris Well, This is the best version to Date (With 2 Player option)

**1452 AMIOMEGA** Similar to Hack/Rogue

**1454 MEGA BALL** (THE BEST ARKANOID GAME. Better than any Full Price Games).

**1509 DESTINATION MOON BASE** An improvement on the Lunar lander game

**1533 LAN II (AD&D)** Adventure Game

**1534 THE HOLY GRAIL** Text adventure similar to the inforgam games.

**1556 SEVEN TILES** Speedball Game

**1558 SHAPES** New tetris variant game.

**1559 AMIOPOLY MONOPOLY GAME**

**1561 TRITWIS 3 PLAYER TETRIS GAME**

**1563 GREYSLAYER BARABRIANGAME**

**1564 MARATHAN MINE III B. DASH**

**1580 NETHACKA** fantasy game in which your goal is to retrieve the Amulet (2, 2D)

**1597 ROLLERPEDE** A space aged version of the classic centipede game. Excellent

**1620 NIBBY NIBBLE** Music By Red Sector

**1622 LORE OF CONQUEST** War game similar in concept to the game RISK.

**1663 PROPERTY MARKET GAME**

**1664 THE CASTLE ADVENTURE**

**1665 BATTLE FORCE ROLE PLAYING**

**1684 QUIZ MASTER NUMBER II**

**1688 ESCAPE FROM JOVI III**

**1689 FAMILY SOLITAIRE GAME DISK**

**1690 AIR ACE II** THE SHOOT EM UP

**1695 NAPOLEON WARSIMULATOR**

**1702 THE STAR TREK TRIVIA GAME**

**1707 IMPERIUM STRATEGY GAME**

**1735 ASTERIODS 'THE ORIGINAL'** Another old classic. Remember that Classic.

**1747 LLAMATRON GAME** By Jeff Minter Brilliant stuff & another excellent New production look forward to more.

**1749 SCRAMBLE** The Original Remember that old classic well is now on the Amiga.

**AMOS PD**

Amos Public domain disks do not require the Amos program.

**APD115 BALLOONACY GAME\***

**APD132 FAMILY HISTORY DATABASE**

**APD146 FRUIT MACHINE SIMULATOR**

**APD151 UNDERSTANDING AMOS** The Amos Tutorial Program Disk. A must

**APD163 THE SAMPLE EDITOR V1.2**

**APD176 AMOS DATABASE MASTER**

**APD180 DUNGEON DELVER GAME (2)**

**APD182 PIXIE KINGDOM GAME (2)**

**APD190 BLACK BELT KARATE GAME**

**APD198 BOMBS FROM BAGDAD GAME**

**APD200 DUNGEON MASTER SHELL**

**APD203 FRACTAL MANIA DEMO**

**APD205 R-DRAW UTILITY PROGRAM**

**APD213 DREAMERS DISK MAGAZINE**

**APD215 FRACTAL WORKSHOP**

**APD221 AMOS BINGO GAME**

**APD222 STEVES SAMPLE DISKS (5)**

**APD230 AMOS ASTERIODS GAME**

**APD233 NEW AMOS COPY PROGRAM**

**APD234 AMOS TEXT W. PROCESSOR**

**APD237 AMOS SHAPES GAME DISK**

**APD238 AMOS IMAGE PROGRAM**

**DEMOS DISKS**

**1002 BUDBRAIN II** Still one of the best mega demos on the amiga

**1016 TOTAL DESTRUCTION** Megademo By Cronic. The Madonna Group.

**1021 USA vs IRAQ Animation\***

**1105 THE JARRE LIVE MUSIC**

**1190 THE TRASH CAN BY WIZCAT** See The dark side of Mickey Mouse

**1206 PLAYBOY JAN 1991 (2) XX**

**1233 VOGUE & JUSTIFY MY LOVE** Some more Madonna music.

**1236 VOCAL ATTACK III** Remixed house music. The Flame Arrows (3)

**1238 ANARCHY** System Violation Mega demo. Another Excellent

**1242 RED DWARF HI-RES PICTURES (2)** Some pictures from aboard the Red Dwarf

**1249 EVE OF THE WAR MUSUC**

**1250 DR. WHO & OTRUN MUS**

**1271 BAYWATCH BERKA PICS**

**1281 NODDY: MONTY PYTHON**

**1295 REBALS & SCOPEX DEMOS\***

**1332 SCHWARZENEGGER** in the Total Remix & a Washing up Advert.

**1343 THE ROB COP 2 SLIDESHOW**

**1404 EMIGMA BY PHENOMENA** This is a excellent mega demo with great graphics

**1417 STAR WARS PICTURES (2)** Excellent art work, this time pictures from Star Wars

**1427 F15 II PREVIEW** Take the chance to see one of the better games. Coming soon.

**1431 DONT MISS THE PART ZONE** House music By the Beatmaster. VERY GOOD

**1441 THE PLASMUTEX 1991** By The flame Arrows. Madonna Music & some excellent graphical effects to run along side.

**1451 JARRE CONCERTS MUSIC** Production by Jean M.Jarre. More jarre music

**1455 I LOVE TECNOLOGIA MUSIC** House music By the Beatmaster.

**1471 ACES OF THE SKY** Agatron:35 The latest animation of two planes (\*)

**1485 BASS HOW LOW CAN U GO** Another Excellent house music

**1499 TOPLESS GIRLS SHOW** Some more top less girly pictures.

**1516 ANARCHY NEW MADNEES II** Anarchy's Latest music disk

**1532 ALIENATION AURAL ECTACY**

**1547 JETSET 'OVERLOAD'** The MTV Braun European Music disk selection

**1569 DO THE BARTMAN (REMIX)**

**1578 GLOBAL TRASH BY SILENTS** A Truly superb interactive demo. This has to be one of the best of all time.

**1586 PAPANOT PREACH** Excellent sampled Madonna music. Excellent disk.

**1592 ITS ON YOU BY MC SAR** This is the best house music (2, 2D)

**1599 BUDNBRAIN III** By Flash productions. Theres some Excellent new sections

**1610 THE VECTOR DANCE** By Cult

**1618 KGB MEGA DEMO** This disk is totally brilliant & really well presented. Better sections than Budbrain II (2)

**1625 INDIANA JONES & THE LAST CRUSADE** The Hi-Res Slideshow (2)

**1627 SHADOW** Present. The Gamb-ling House totally interactive demo.

**1628 MAG. FIELD vs 3RD BASE PD**

**1629 THE SIMPSONS Animation:** By Decay. Totally excellent disk

**1669 MADONNA (2)** Shes back with more excellent pictures colour pictures.

**1671 MAGICIAN ANIM VERSION \* 2** Another Excellent ray traced Animation

**1698 REINCARNATION OF SGT (2)**

**PEPPER** Freaky colourful graphics

**1713 PLAGUE OF DOOM** The Ultimate Music selection collection disks (2)

**1715 SINKING DEMAND/VECTOR** is a cool looking mega demo with colourful effects

**1720 MANIC RAVES BY EMDLESS PIRACY** Excellent hard hitting tracks (2 disks)

**1727 ZEUS** Mega demo, stunning graphics, sound & Loading section.

**1728 MYSTICAL TUNES BY VERICAL** Superb choice of music tracks to listen to.

**1729 NO TECH BY BASS:** Loud music & animating effects. very good indeed.

**1736 MADONNA** Slideshow III Best Madonna slide show to date (3)

**1740 DRUMS & PIPES** Music collection high Quality sound not to be missed.

**1741 KLF MUSIC DISK** Sator presents this great music disk production disk.

**1742 CRUSADERS EUROCHART JULY** See what the best Mega demos are, the best games, utilities & loads more.

**1743 SWIM SUIT CALENDER GIRLS (2)** Crusaders Picture slideshow n1991.

**1746 ANARCHY INSPIRATION IS NONE** Latest & the best ever mega demo from one of the best Amiga demo groups.

**1748 SILENTS MEGA DEMO CALLED ICE** This is there latest mega demo & is totally stunning. Totally Excellent **DEMO OF THE MONTH.** Thanks go out to the silents.

**1750 PINK FLOYD THE WALL (6)** Six disks & requires one Meg & 2 drives. Reviewed.

**1756 UPGRADE ANIMATION (6)** Six Disks & Totally Excellent Anim (1.5Mb)

**WE ARE OPEN SATURDAYS**

JUST WAHT DO WE STOCK  
OVER **3,300**  
DISKS FOR THE AMIGA  
**THE LAREST UK AMIGA LIBRARY.**  
FRED FISH.....1-510+  
TBAG.....1-55+  
**AMICUS, SLIP DISK, APDC, AMOS, PANORAMA, FLETCHER FONTS, SCOPE, LICENCEWARE (POLLY),**

**ERIC SCHWARTZ**

**F413 STEALTHY MANOEUVRES II,** SWISSARMY & THE JUGGLER (1MB)

**F414 BATMAN, LATENIGHT, TERMINAL ANIMATIONS (1MB REQUIRED)**

**F423 MISS MAM 'A' SELE: POGO**

**1034 AT THE MOVIES ANIM (1MB)**

**1582 AMY vs THE WALKER (1MB)**

**1700 ANTELEMMINS ANIMATION** 2MB REQUIRED, 2 DISKS REQUIRED

**1702 THE DATING GAME ANIMATION** 3MB REQUIRED, 2 DISKS REQUIRED

**STARTREK SECTION**

**0186 ORIGINAL ANIMATIONS (2\*)**

**1029 THE USS ENTERPRISE ANIM\***

**1030 BIRD OF PREY ANIMATION\***

**1031 THE FLEET MANEUVER ANIM\***

**1032 THE WRATH OF KHAN ANIM\***

**1033 APPROACHING STAR TREK\***

**1060 STAR TREK NEXT GENERATION**

**1081 THE ULTIMATE STAR TREK (2)**

**1107 STAR TREK KINSONG (2, 2D)**

**1254 STAR TREK THE SHOOT EM UP**

**1349 AMERICAN STAR TREK** Latest with extra sound & graphics (\*2D, 2)

**1465 NCC WORKER BEE TREK\***

(N) = NUMBERS OF DISKS  
\* = 1MB MEMORY REQUIRED  
(2D) = NEEDS TWO DISK DRIVES

**FRED FISH UPDATE**

**F491 BBASE II** A simple Database that stores, sorts & searches for information.

**F492 SUPERBASE PRO** Trial version complete with sample application V1.0

**F495 ANALYTICALC SPREADSHEET** This version is now directly executable.

**F499 MATLAB A** New Fortran Package

**THE PD DATABASE SET**

These's 2 Disks contain well over  
**3,300**  
Amiga Public Domain disks,  
ALSO COMES WITH A PRE-PRINTED LIST OF ALL THE TITLES.  
only **£1.50**

**FRED FISH BOOKLET**

Ever wanted a complete description of all the Fred Fish disks on Paper? Well, the entire list is now ONLY available from PDSOFT. over 90 Pages revealing everything about every program in this range as described by Fred Fish.  
(Currently Upto Disk F510)  
This includes Sorted Index Of Every Program! Only **£2.50**

**POLLYSOFT LICENCEWARE £3.00**

**L1 - SPACE BLOB:** Platform Game similar to Manic Miner

**L2 - MR DIG (1Mb):** Eat the earth, munch the cherries.

**L3 - Q-BOID:** Shoot blocks upwards to fill the shapes before the screen falls upon you. Played Tetris when try this variant.

**L5 - SUBCULTURE:** R-Type clone where you have to shoot down waves of space ships flying towards you. All 5 Levels.

**L7 - DIZZY LIZZY (1Mb):** A Boulderdash clone with extra large graphics. Collect all the diamonds & avoid the monsters. Reviewed in CU Amiga.

**L8 - LIZZYS FUNTIME SHAPE, CLOCK PICTURE & KEYS, MONEY, SEASONS & MOUSE (2 DISKS)** Both reviewed in Amiga Format (June 1991). Educational

**L11 - TRON DIMENSION X (1MB):** Brilliant Light Cycles Game. ONE OR TWO PLAYERS

**L12 - THE ULTIMATE GRABBER:** 100 times better than the Amos Sprite grabber program. A must for Amos programmers.

**L13 - BOUNTY HUNTER (1Mb):** Take Lucky Lukethrough a Graphic adventure, Excellent arcade shoot outs where you contoll the Gun, then ride your horse & take out the bad guys. Shoot out sequences like Operation Thunder Bolt.

**L14 - CLASSROOM MATHS EDUCATIONAL PROGRAMS:** New Education programs from the creators of LIZZY'S FUN TIME 1 & 2. See Future reviews for more details.

**CW1 - BASS O MATIC (2 DISKS):** Some excellent Crusaders Music & graphics

**CW2 - TUFFENUF MEGA DEMO:** Excellent production with various Great sections. In the Crusaders Cartoon charater. Reviewed in Amiga Format July.

**VIDEO FONTS 4 £15.00**

**FLETCHER VIDEO FONTS PACK 4:** Colour Pack 4 (FFP4) Six disks packed with a varied assortment of coloured fonts. in many colours, shapes & sizes. For use with Dpoint programs or any Video production utilities. This latest has some totally outstanding fonts and for only £15 they give you over 70 fonts to play with. Have fun

**PRICES ARE PER DISK**

1-5 Disks 2.50    6-10 Disks 2.25  
11-20 Disks 2.00    21-49 Disks 1.75  
50-99 Disks 1.50    100+ Disks 1.25  
With Exception to Licenceware, Special Public domain Packs & Blank Media  
When ordering XXX Disks please state that you are over 18 Years old  
ALL ORDERS DISPATCHED WITHIN 48 HOURS  
CLEARED FUNDS ONLY

**ORDERING DETAILS**

PLEASE QUOTE THE DISK NUMBERS WHEN ORDERING BY PHONE OR POST. ALL PRICES INCLUDE V.A.T., 1st CLASS POSTAL COSTS & PACKING.

**ORDERING BY POST:**  
PLEASE SEND A CHEQUE OR POSTAL ORDERS MADE PAYABLE TO PDSOFT (DEPT AF26), 1 BRYANT AVE, SOUTHEND-ON-SEA, ESSEX, SS1 2YD  
PLEASE INCLUDE THE FOLLOWING DETAILS WHEN ORDERING BY POST, YOUR DAY TIME PHONE NUMBER & IF YOU HAVE ORDERED FROM US BEFORE.

**FOREIGN ORDERS:**  
ALL ORDERS SENT BY AIR MAIL. FOR EUROPEAN ORDERS PLEASE ADD 10% (MINIMUM £1.00). INTERNATIONAL & EUROPEAN CREDIT CARD ORDERS WILL BE CHARGED POSTAGE AT COST. ANY CHEQUES MUST BE DRAWN ON A U.K. BANK (OR CASH BY REGISTERED MAIL).

**ORDERING BY TELEPHONE:**  
TELEPHONE HOTLINE OPEN SIX DAYS A WEEK FROM 9AM - 8PM WEEK DAYS AND FROM 9AM - 8PM ON SATURDAYS.

**COLLECTING DISKS AND ORDERS:**  
PLEASE RING (0702) 466933 BEFORE CALLING SO THAT WE MAY PREPARE (OR COPY) THE PUBLIC DOMAIN DISKS THAT YOU REQUIRE.

**PRE-PRINTED LISTS (ALL ARE FREE OF CHARGE):**  
WE NOW OFFER A LASER PRINTER SERVICE. IE IF YOU WOULD LIKE INFORMATION ON ANY OF OUR PUBLIC DOMAIN DISKS JUST ASK.

# PD Demo Zone



## THE REINCARNATION OF SGT PEPPER

Amiganuts United, Disk 1105  
Requires One Meg



This demo should please all the Beatles fans. The disk contains various pieces sampled from the Sergeant Pepper album, accompanied by some wonderful psychedelic images. If Sixties imagery is your cup of tea, then this is definitely worth checking out.

## 20 SECONDS TO COMPLY

17 Bit, Disk 1143

This is what we want to see! Hard-core rap music in the PD scene! This disk contains two versions of Silver Bullet's 20 Seconds to Comply. One of them is a standard version for 512K Amigas, whereas the second mix is designed for users only with 1Mb of chip RAM available. I suggest you get hold of it, load it up and crank up those decibels.

## THE INVISIBLE WORLD

The Disk



This is one of the strangest demos to come along for some time. If you're one of those people that finds bugs and other creepy crawlies too horrible to contemplate, then this disk is most certainly not for you. The demo features some superbly digitised pictures, ranging from magnified pictures of grubs, lice and mites to freeze-frame pictures of bullets fired through objects. Although it seems to be rather text-book stuff, it makes for quite an interesting slideshow.



POP! - A brilliant flash from a strobe light, lasting twenty-five millionths of a second, captures the moment the balloon is popped.

Right. Switch off that stereo for a minute. What do you mean, you want to listen to your new record? You're better off with some of the stuff **Maff Evans** has been playing - it will knock your boots off. If it's hip sounds you want, then PD is the place to look. You've got your hip dance, your ethereal soundtracks and spiffy visuals to boot. Want to know more? Then read on...

## LANDING

Amiganuts United, Disk 1103  
4 disks - Requires 4 Meg

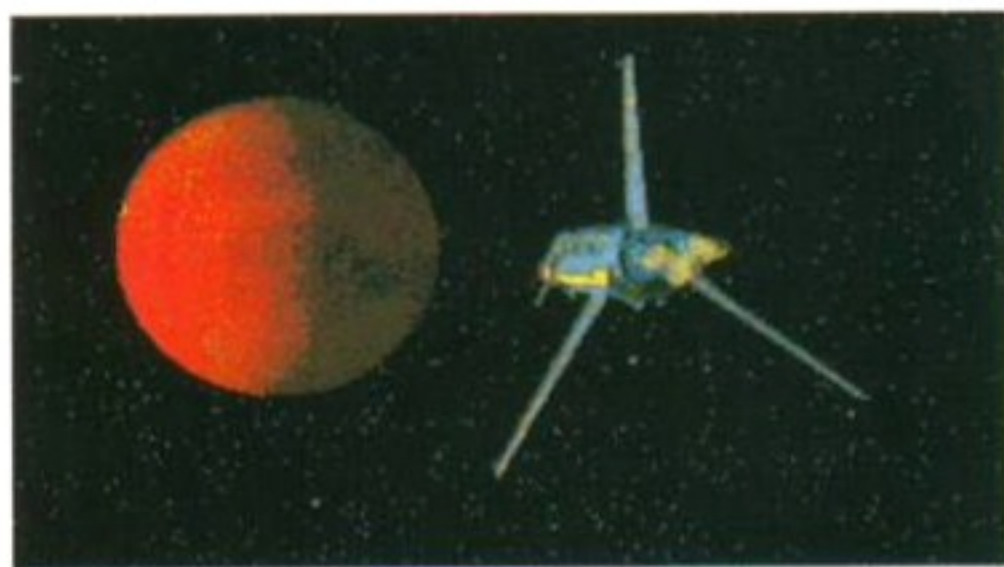

When it comes to futuristic science-fiction animations, then Tobias Richter is well in front of the field. With his Agatron label he has brought us some of the most impressive ray-traced space clips ever to be seen on a home computer, and *Landing* is no exception. It starts in a landing bay, the demo follows the launch, flight and docking of a shuttle craft. There is no sound, but this doesn't matter because the visuals are of such an incredibly high standard. The only problem is it needs an almost ludicrous amount of memory to run - in fact it's almost good enough to warrant buying a memory expansion to watch it!



## EVOLUTION SLIDESHOW

17 Bit, Disk 1070

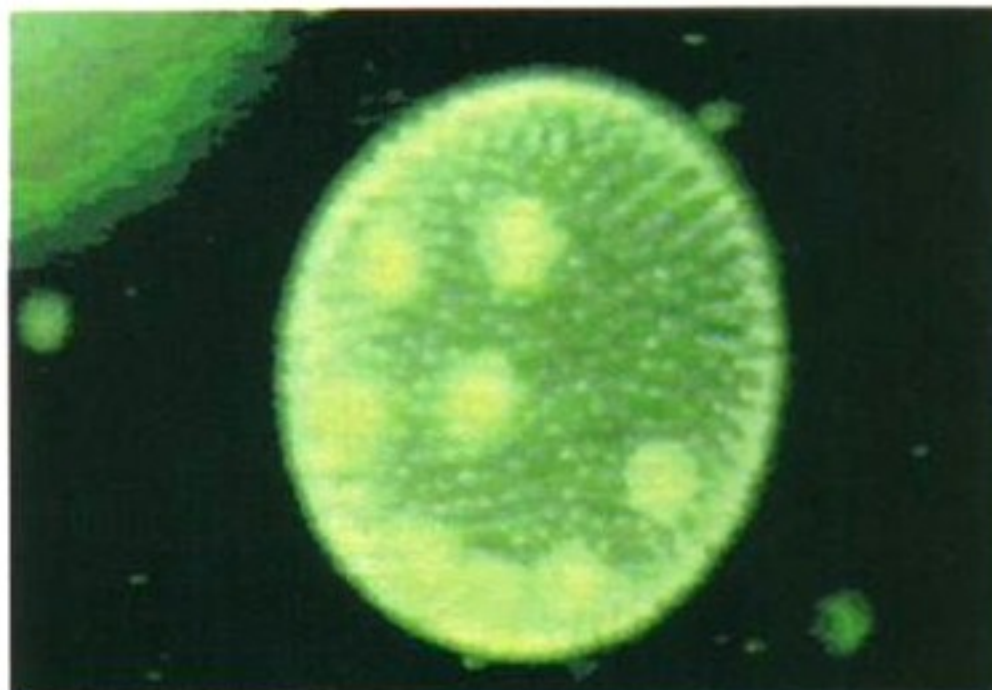

This is a strange one, make no mistake! The demo plots the evolution of life on Earth using a series of digitised HAM pictures, from a single-cell animal via fish-life to lizards and mammals. The pictures are pretty good, being clear and colourful, but it's not very interesting apart from that. Still, all you budding anthropologists may find it intriguing.

## MR POTATO HEAD

17 Bit, Disk 1091

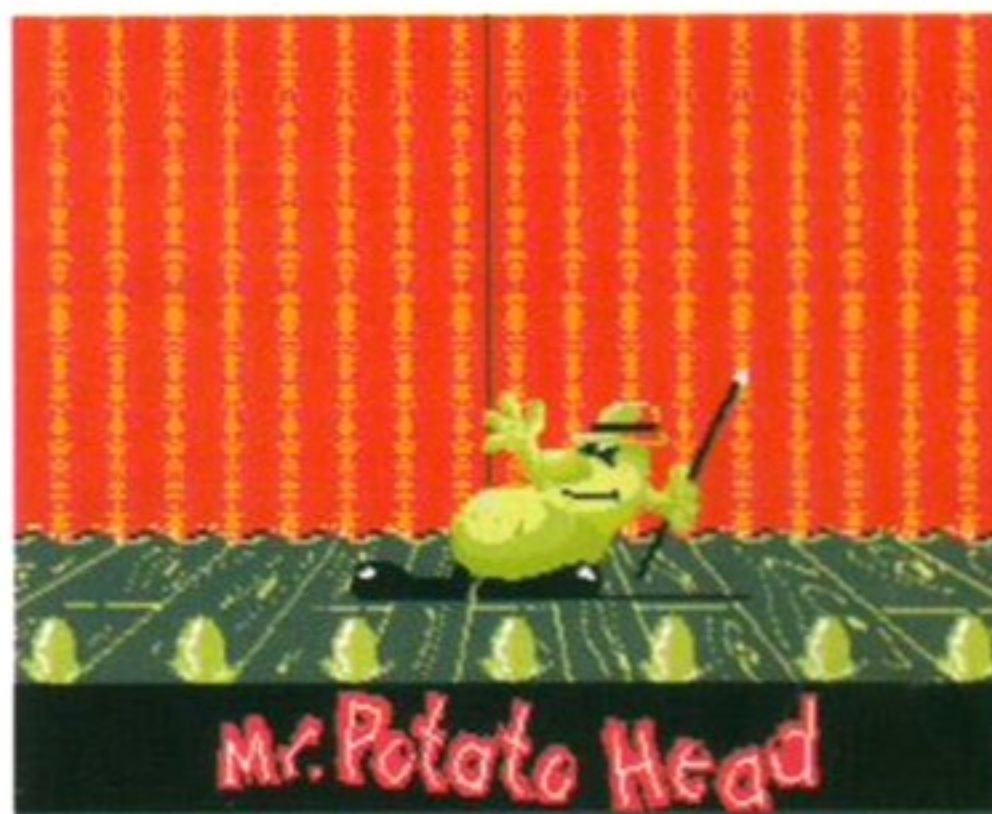

It's good to see demo coders injecting humour into their demos every now and then, and *Mr Potato Head* is a prime example of this. The vegetable star of the title makes his premier stage performance in this clip, doing his best to entertain the audience. A fact which is made difficult by his inability to dance! A funny little cartoon which will cause a smile or two.

# BLITTERCHIPS AMIGA PD

## UTILITIES

- 12 Bootbench v2.0, intro creator
- 54 Utilities disk 4 by Red Devil
- 227 T.V. Graphics, and fonts (2 disks)
- 228 Video applications (2 disks)
- 251 Blitterchips virus killer disk
- 282 Darkstar utils disk 2
- 283 Darkstar utils disk 3
- 318 Dope the intro maker
- 345 Extravaganza, 26 utilities
- 377 Red Devils utils disk 6, superb!
- 408 Audio utilities from the Warriors
- 435 ARP V1.3 with full documentation
- 445 Sydney & Friends, SID and loads more
- 471 Jazzbench, replace your workbench
- 506 DBW render, ray tracing program
- 549 Home utils, Wordwright, Scalc etc
- 573 The Clerk V3.0, Accounting program
- 613 Soundtracker Professional (Protracker)
- 616 D-Copy, very good copier indeed
- 623 C-Light, ray tracing program very good
- 636 Razor 1911 Tooldisk, loads of utils
- 640 Mobed V1.0, a Movable Object Editor
- 641 Speedbench, a faster loading W/Bench
- 647-653 Volumes 1-7 clip art by Andy Hughes (may be purchased separately if required)
- 701 P.D. Spectacular, 40 utils on this disk
- 706-715 Ten disks of instruments for MED, Soundtracker etc. ST-01 to ST-10, may be purchased separately if required
- 735 Flexi Base, a more friendly data base
- 793 Red Sector demo maker V1.0 great! (\*)
- 813 Startrekker V1.2 Soundtracker clone
- 819 NIALL V2.1, teach your Amiga English!
- 843 ICONMANIA, mess about with icons, good
- 846 Joy of Printing, 28 new Amiga fonts
- 868 Utils disk 1, By C. Palmer. V.Good.
- 877 NORTH C V1.3 please note 2 disk set
- 898 Audio Magic V1.1, full of useful utils
- 945 Graphics utils, V.Good run from W/B
- 956 C-Manual V2.0. Please note 4 disk set
- 993 Master Virus Killer V2.1, kills 124!!
- 994 Q-Base, (data base) and Spread also.
- 996 A-Genie, a Genealogy data base (\*)
- 997 Sound Applications, please note 2 disks
- 1008 Graphics Management, V.Good 2 disk set
- 1017 Deskbench, smarten up your workbench
- 1018 Bases, for use with deskbench
- 1019 Icons, all that a good deskbench needs
- 1027 Blitterchips fonts disk for the RED-SECTOR demo maker. 22 Fonts, size 32 by 32 ready for you to use, don't miss this!!
- 1060 MED V3.11b, latest bug fixed version!!
- 1061 MessySID, read PC MS DOS the easy way
- 1062 Something for nothing, great set of graphic utils etc, V.Good, note 2 disk set.

## ANIMATIONS

- 4 Walker demo 1 from Star Wars (\*)
- 5 Walker demo 2 from Star Wars (\*)
- 16 Luxor Teenager, Ray traced animation (\*)
- 43 Puggs in Space, a cute and funny demo
- 79 Education of Cool Cougar, very funny (\*)
- 101 The very famous "Gymnast" demo (\*)
- 291 The Lotus car chase from Agatron (\*)
- 313 Revenge Horror show, for psycho's only
- 394 Stamp collector, an old but good demo
- 444 Fillet the Fish, similar to Puggs demo
- 487 Magician and Jogger. Requires w/bench (\*)
- 582 Stealthy II Manoeuvres, great cartoon (\*)
- 625 Juggler II, the Juggler meets a lady (\*)
- 631 Steves animations 1, has 8 cute anims
- 632 Steves animations 2, has 6 cute anims
- 633 Batman the Movie, funny and amusing (\*)
- 762 Porky Pig animation, funny cartoon (\*)
- 763 Basketball player, superb ray tracing (\*)
- 789 Steves animations 3, has 6 cute anims
- 790 Steves animations 4, has 5 cute anims
- 791 Steves animations 5, has 6 cute anims
- 805 Franklin the Fly, hilarious and funny (\*)
- 863 Iraq demo, rather comical animation
- 865 Coyote Strikes back, poor Roadrunner (\*)
- 866 Ami versus the Walker as reviewed (\*)
- 913 Mars, smooth space fighter animation (\*)
- 917 Juggette and Juggette the revenge (\*)
- 1041 Trackball animation by Dr. Gandalf (\*)
- 1044 Chaos in motion, Mandelbrots 2 disks (\*)
- 1046 Ultra graphics anims, Ghostbusters (\*)
- 1047 Anti-Lemmings, superb anim from Eric-Schwartz. needs, 2 Meg mem, 2 drives, (2 disks)

## MUSIC

- 2 I should be so lucky by Kylie (2 disks)
- 301 Darkstar's music 9, 14 tunes (2 disks)
- 417 Electric Youth, Debbie Gibson (2 disks)
- 420 Lumberjack song, Monty Python (2 disks)
- 478 Made in Heaven by Kylie (2 disks)
- 525 Flash by Queen, superb sample (2 disks)
- 581 D-Mob music 4, good music (2 disks)
- 703 808 Remixes from the Beatmaster who else?
- 716 Bomb the Base, 8 fab tracks to listen to
- 718 Revolutions by Jean Michelle Jarre
- 722 Vocal attack the sequel, thumping music
- 723 Sounds of DOB II, 17 tracks of music (\*)
- 767 The 900/Oxygen remix, collect it now (\*)
- 770 Arcane music, 11 tracks for you to play
- 794 In a Silent Way, Don't miss this disk!
- 796 Crusaders does Genesis, superb (\*)
- 798 Doin' the doo, B. Boo (2 disks/2 drives)
- 799 Wanted-Dead or Alive (2 disks/2 drives)
- 847 The Wall by Pink Floyd, sample of hit
- 848 A kind of magic, by Queen. sampled (\*)
- 849 Do they know it's Christmas (2 disks)
- 856 The power of love, Huey Lewis (2 disks)
- 968 Followin you, by Madonna (2 disks)
- 969 Walk like an Egyptian by Bangles, sample
- 970 If only I could, Sidney Youngblood sample
- 971 Winkers song, over 18yrs only (2 disks)
- 977 Mystify, sample of INXS record
- 978 Give Me what I want, Sam Fox sample
- 980 Jarre Live, eleven good tracks of music
- 1030 Vivaldi's Four Seasons more of Rob Baxters superb classical music (2 disks)
- 1079 I love Technology by the Beatmaster
- 1080 Mean Machine, good music (2 disks)
- 1081 Groove is in the Heart, sample (\*)
- 1082 Walk this way, remix by N. Henthorn
- 1084 The Golden Stars top twenty (2 disks)

## GAMES

- 78 The Holy Grail, a very good adventure
- 223 Moria. Another adventure game (\*)
- 317 Star Trek. Please note, 2 disks
- 362 Callisto, Daleks, Puz and Pontoon
- 363 The Golden Fleece, a text adventure (\*)
- 374 Colossus, another adventure type game.
- 418 Frantic Freddie the P.D. game, good fun
- 441 All New Psuedo Cop game, a shoot em up
- 458 Castle of Doom, adventure with graphics
- 459 Buggy Commando, playable demo, good fun
- 460 Flaschbier, a boulderdash P.D. game
- 477 Return to Earth, Space Combat/adventure
- 485 Grav-Attack, 17 distinct levels
- 511 Train Construction, make your own tracks
- 551 Cluedo and Monopoly, 2 great games
- 552 Eat Mine, has 80 screens to play at
- 553 Retaliator and Pacman, 2 great games
- 555 Drip, a painter type of game, great fun
- 556 Super Off Road Racer, playable preview
- 557 Silkworm 4, Playable shoot em up demo
- 558 Murder, an adventure playable preview
- 559 Back to the Future, playable preview
- 562 Spaceblitz, 4 good games to play
- 644 Horror Zombies, playable game preview
- 646 Tennis, great game of tennis (\*)
- 665 Killing Game Show, playable preview
- 666 Plotting, 5 level playable demo, brill
- 668 Cybercon III, playable game demo
- 672 James Pond and Paratroid playable demos
- 699 Yelp, a Painter type game, Multi-levels
- 700 J.A.R. avoid the monsters, addictive
- 746 Paratroid, playable preview, fast action
- 749 Turracan, playable shoot em up demo (\*)
- 899 Wraithed One, super fast quiz game
- 900 Blizzard, fast scrolling shoot em up
- 902 Mayhem, avoid the traps, addictive
- 1012 Excalibur, great shoot em up (\*)
- 1014 Chinese Checkers, similar to solitaire
- 1015 Megaball, very good breakout game
- 1028 Rings of Zon, adventure type game (\*)
- 1029 Seven Tiles, superb ball game, get it
- 1064 Ultimate Ride, playable preview. Good
- 1066 Simpsons game, simple shoot em up
- 1067 Star Trek, another simple shoot em up
- 1068 Twintris, superb Tetris variant
- 1069 Downhill Challenge, playable demo
- 1072 Battle at the edge of time, shoot em up

**LARGE SELECTION OF ADULT GLAMOUR DISKS AVAILABLE TO OVER 18yr OLDS**

## DEMOS

- 132 Dragons demo 1, has lovely raster effects
- 22 Kefrens Mega demo 7, good multi part
- 44 Trilogy mega demo, V.Good (2 disks)
- 45 Kefrens mega demo 8, superb (2 disks)
- 66 Predators demo, plus game (2 disks)
- 95 Dexion mega demo, many varied parts
- 121 Mental Hangover by Scoopex, v. good.
- 174 Ian & Micks mega demo, 9 parts to this
- 199 Red Sectors mega demo, Brill (2 disks)
- 201 R.A.F. mega demo, superb (2 disks)
- 287 Golam Gates Mega demo II, worth getting
- 290 Red Sectors "Cebitt" great vectors
- 321 Fractal flight animation, unusual demo
- 365 Budbrain (over 18 yrs for this, 2 disks)
- 475 Dream Pack by Tom Soft, very good disk
- 516 Purple, very large vector routines
- 539 Chromium, a great new demo by Scoopex
- 547 Materealized, Cryptoburners superb demo
- 594 Hit the Road by Flash, (2 disks)
- 597 Cool Fridge, superb Plasma effects here
- 598 Fractal animation, super mandelbrots (\*)
- 599 Neverwhere by Crionics, interesting
- 614 Monty Pythons "Nudge Nudge" (2 disks)
- 617 The Byte Busters Mega demo, good
- 654 Olympia, parallax scrolling at its best
- 655 Unreal game demo, to show off your Amiga
- 656 Pussy Innership, good graphics and game
- 657 Goldfire mega demo, nice lips!
- 750 Budbrain II a new disk from Budbrain
- 751 Colour Cycling, superb effects, get it!
- 759 Amos Creator II demo, official release
- 807 Evil Dead demo, for all you Psycho's (\*)
- 982 Total Rebate, from the Steve Wright show
- 983 Total Retrial, from the Steve Wright show
- 984 Total Restyle, from the Steve Wright show
- 985 Total Respray, from the Steve Wright show
- 986 Total Recount, from the Steve Wright show
- 1095 The Undertaker, sample of Monty Python
- 1099 Substance by Quartex, super demo, good
- 1101 Enigma from Phenomena, terrific demo

## AMOS LICENCEWARE

### OFFICIAL DISTRIBUTOR

- LPD1 Colouring book (\*) for children
- LPD2 Arc Angels maths. (\*) for children
- LPD4 Thingamajig (\*) for children
- LPD5 Jungle Bungle (\*) for children
- LPD6 Pukadu & Sprites (\*) game
- LPD7 4 Way Link (\*) game
- LPD8 Learn & Play (\*) for children
- LPD9 Amos Assembler V1. (\*) util
- LPD10 Word Factory (\*) for children
- LPD11 Go Getter game (\*) game
- LPD12 Hypnotic Lands (\*) game
- LPD13 Jigmania (\*) game
- LPD14 Play it Safe (\*) for children
- LPD15 Angels Shapes (\*) for children
- LPD16 Reversi II (\*) game
- LPD17 Dogfight II (\*) game
- LPD18 Touchstones (\*) game
- LPD19 X-IT-50. (\*) game
- LPD20 Wordy. (\*) word processor
- LPD21 Quingo (\*) quiz game
- LPD22 LC10 Fonts. (\*) utils
- LPD23 ESP. (\*) game
- LPD24 Shining Way of Kung Fu (\*) game
- Please note, LPD24 is a 2 disk set. Special price £5.50
- LPD25 The Mission (\*) adventure
- LPD26 C.Y.A.D. (\*) puzzle game

PLEASE NOTE LICENCEWARE IS £3.50 a disk, which includes a contribution to the programmer £3.50 A DISK set by Amos P.D.

**LAST MONTH AT THESE CRAZY PRICES!**

**99p each disk**

PLEASE ADD 60p for P/P to your total order value U.K. orders  
PLEASE NOTE: Disks marked (\*) require 1 Meg of memory

Please note that all AMOS P.D. is £1.50 per disk. This is a selected list of the very best of the new AMOS Public Domain. This selection does NOT REQUIRE AMOS to run.

- APD100 (DEMO) Amos demo 2
- APD102 (GAME) Chainsaw death (1 Meg)
- APD103/4 (GAME) Pick up a Puzzle (2 disks, 1 Meg)
- APD105/6 (GAME) Picture it (2 disks, 1 Meg)
- APD109 (DEMO) Birds of Prey picture show
- APD110 (GAME) Cross Fire (1 Meg)
- APD115 (GAME) Balloonacy (1 Meg)
- APD123 (GAME) Deadline (1 Meg)
- APD124 (DEMO) Bob Maniacs
- APD130 (GAME) The Wooden Ball (1 Meg)
- APD131 (DEMO) Armageddon (1 Meg)
- APD132 (UTIL) Family History Data Base (1 Meg)
- APD135 (EDUC) Simon and Space Maths
- APD137 (GAME) Tile Trail
- APD143 (DEMO) Cybernetics (1 Meg)
- APD146 (GAME) Fruit Machine and Fruit Crush
- APD160 (QUIZ) Quizmaster (1 Meg)
- APD175 (GAME) Mutant Zombie Psycho Pigs (1 Meg)
- APD176 (UTIL) Database Master (1 Meg)
- APD178 (GAME) Master Mind and Pair Up (1 Meg)
- APD180/1 (GAME) Dungeon Delver (2 disks, 1 Meg)
- APD182/3 (GAME) Pixie Kingdom (2 disks, 1 Meg)

**PRICES ARE PER DISK. PLEASE NOTE: SOME TITLES ARE MORE THAN 1 DISK.**

## FRED FISH DISKS

We now have the complete library in stock from disk 1 to disk 490 only 99p each disk

## T-BAG DISKS

We stock from disk 1 to 54 only 99p each

Now over 1,800 titles in stock, full details are on our catalogue disk for only £1, or sent free with your order

Phone and collect service now available

Orders are despatched the same day

Now over 12 years of business experience behind us

Vast stocks are held so no waiting and no delays

We are open 10am-7pm, Monday-Friday and 9am-4pm Saturdays

You can Fax your order to us on **(0535) 667469** MINIMUM ORDER 3 DISKS BY CREDIT CARDS

## OVERSEAS ORDERS

please add 30p per disk Europe, 60p per disk rest of world.



### HOW TO ORDER

Write down the number of disks you require and send it with your cheque, a postal order or your Access/Visa card details to:-

**GUARANTEED**

BLITTERCHIPS, "Cliffe House", Primrose Street, Keighley, West Yorkshire BD21 4NN or you can phone our credit card HOTLINE with your order today. **(0535) 667469** VAT registration No. 181 2908 62.

**IMPORTANT NOTICE, TRADE DUPLICATING** Our commercial duplicating plant is available for trade duplication, if you want 100 copies or 5,000 then give us a ring and ask for Steve, we will gladly give you a quote, fast turnaround and high grade disks. Formats available: IBM PC, ST, AMIGA.

# MEGA BLITZ!

THE ONE STOP SHOP FOR AMIGA PD SOFTWARE

PHONE 0782 208228 FAX 0782 281506

THE DISKS BELOW ARE ONLY A SMALL SELECTION FROM OUR VAST LIBRARY OF OVER 2000 DISKS

## UTILITIES

PDU 10 Word Processing+Databasing  
 PDU 16 Air Tunnel Simulation  
 PDU 31 Fish#143 RIM Database  
 PDU 32 Fish#144 Analytic spreadsheet  
 PDU 43 Fish#203 Assembler & C eg  
 PDU 44 Fish#215 Mandelvroom V2.0  
 PDU 45 Fish#210 Scientific calculator  
 PDU 46 Fish#213 Icons(300 in 8 colors)  
 PDU 51 Fish#219 Astronomy program  
 PDU 52 Fish#52 A-Z Text Editor  
 PDU 60 Fish# 237 CLlprint  
 PDU 70 Fish 193 Keymap Editor  
 PDU 72 SID V1.06 The ultimate disk util.  
 PDU 80 Fonts and Surfaces  
 PDU 81 Disksalve 1.3  
 PDU 98 Celtics Demomaker  
 PDU 99 Ham Radio utils(5 disks)  
 PDU 101 Menu-Maker  
 PDU 102 Label designer  
 PDU 103 Icon-Maker  
 PDU 104 Icon-Mania  
 PDU 105 Crossword Creator  
 PDU 118 Various CLI utils  
 PDU 149 Icon Fun  
 PDU 151 Fixdisk-disk repairer  
 PDU 164 Games Music Creator  
 PDU 168 Vaccine-Booster(Virus killer)  
 PDU 169 QuickBase-Database  
 PDU 185 ANC22 (Excellent utils)  
 PDU 186 Falcon Bootblock Creator  
 PDU 194 Pman Virus Killer  
 PDU 200 Virus Killer Pro V2.0  
 PDU 207 PerfectSound V1.93  
 PDU 257 Fish#349 MED V 3.00  
 PDU 262 MED Modules  
 PDU 318 Red sector demo maker  
 PDU 349 Master virus killer V 2.1  
 PDU 358 Tetracopy

## DEMOS

PDD 1 Anarchy Demo  
 PDD 4 Deathstar Megademo(2 disks)  
 PDD 7 Elvira Demo  
 PDD 14 RAF Megademo(2 disks)  
 PDD 16 Robocop Demo  
 PDD 20 SAE Demo#25  
 PDD 21 SAE Demo#32  
 PDD 31 Anarchy"Ooh its obscene III"  
 PDD 51 Hacktrick#1 Arsewipe  
 PDD 52 Hacktrick#2Smashing day out  
 PDD 55 Kefrens Megademo 8(2 disks)  
 PDD 62 Northstar Megademo#2  
 PDD 70 Rebels Megademo  
 PDD 72 Red Sector Demodisk#4  
 PDD 73 SAE Demos#23  
 PDD 74 SAE Demos#36  
 PDD 75 Scoopex Demos  
 PDD 76 Scoopex Megademo  
 PDD 91 Trilogy Megademo#1  
 PDD 94 Vortex Megademo  
 PDD 96 Magnetic Fields Demo#36  
 PDD 97 Predators Megademo(2 disks)  
 PDD 107 Budbrain I (2 disks)  
 PDD 115 Magnetic Fields Demo#40  
 PDD 116 Magnetic Fields Demo#41  
 PDD 130 Chubby Brown  
 PDD 131 Crionics Demo  
 PDD 132 Giants Megademo(2 disks)  
 PDD 134 Magnetic Fields Demo#45  
 PDD 145 SAE Demo#31  
 PDD 152 Flash"NO Brain NO Pain"(2)  
 PDD 153 Billy Connally Demo(2 disks)  
 PDD 160 Hacktrick"Rave-on"  
 PDD 177 Budbrain II  
 PDD 179 Crionics Total Destruction  
 PDD 186 Flash Demos#2  
 PPD 209 Rutger Demodisk  
 PDD 212 Space Pack#32

## ANIMATION

PDA 9 Knight Animation(1 meg)  
 PDA 12 Agatron Star Trek Anims 2  
 PDA 13 Agatron Star Trek Anims 17  
 PDA 14 Puggs in Space  
 PDA 18 Miller Lite Advert  
 PDA 31 Nude Girls Anim  
 PDA 34 Basketball Anim  
 PDA 35 BFPO Slideshow(18+)  
 PDA 36 BFPO Slideshow#2(18+)  
 PDA 41 Digiviewer Slideshow  
 PDA 42 Dragons Lair Demo  
 PDA 45 Monocycle & Sportscar(1 meg)  
 PDA 47 Holsten Pils Advert  
 PDA 49 Mayfair Vol.23 no3(18+)  
 PDA 50 Mega Clean Show V1.7  
 PDA 54 NASA Graphics  
 PDA 56 Newtek Demoreel1(2)(1meg)  
 PDA 57 Newtek Demoreel3(2)(1meg)  
 PDA 56 Newtek Demoreel1(2)(1meg)  
 PDA 57 Newtek Demoreel3(2)(1meg)  
 PDA 58 Paradise Slideshow  
 PDA 61 Sabrina  
 PDA 63 Space Anims(1 meg)  
 PDA 65 Star Trek Anims  
 PDA 68 Walker Demo1 (1 meg)  
 PDA 69 Walker Demo1 (2meg,2disks)  
 PDA 70 Walker Demo2(1 meg)  
 PDA 73 Westcoast Cracker#4(18+)  
 PDA 74 Bodeans Bordello#1(18+)  
 PDA 75 Bodeans Bordello#4(18+)  
 PDA 76 Playboy(18+)  
 PDA 77 Sam Fox(18+)  
 PDA 78 Utopia#1(18+)  
 PDA 79 The Final Ecstasy#1(18+)  
 PDA 80 Walker Demo 2(2 meg,2 disks)  
 PDA 81 Ray Trace Art.DBW Render util  
 PDA 86 Utopia#4(18+)  
 PDA 89 Bodeans Bordello#9(18+)  
 PDA 90 Bunsen Burner-JetFighter anim  
 PDA 92 D.Landers Sci-fi Show#1  
 PDA 93 D.Landers Sci-fi Show#2  
 PDA 110 Bruce Lee Enter the Dragon  
 PDA 11 Bruce Lee Slideshow II  
 PDA 112 Dragons Lair II Demo  
 PDA 114 Neighbours Slideshow  
 PDA 116 Terminator

## MUSIC

PDM 5 MFI'Electric CLI IV'  
 PDM 6 Winkers song(2 disks)  
 PDM 9 Ride on time & Batdance  
 PDM 19 Bad-M.Jackson  
 PDM 20 Bat Dance  
 PDM 27 DMOB Megamusic III  
 PDM 28 Enemies Music III  
 PDM 30 Digital Concert II  
 PDM 31 Digital Concert III  
 PDM 33 Helloween'Follow the Sign'(2)  
 PDM 35 Think were alone now-Tiffany  
 PDM 36 Land of Confusion-Genesis  
 PDM 38 Miami Vice Theme (4 disks)  
 PDM 40 MFI Vangelis Demo  
 PDM 65 Digital Concert IV  
 PDM 72 Popeye meets the Beachboys  
 PDM 80 Digital Concert VI  
 PDM 82 Freddy Kruger  
 PDM 83 Kefrens Jukebox  
 PDM 84 Madonna-Hanky panky  
 PDM 85 Miami Vice-Croquets Theme  
 PDM 87 RIP Eruption  
 PDM 88 Slab Music  
 PDM 91 100 Most Remembered C64 tunes  
 PDM 95 Hi-Fi Demo  
 PDM 104 BassX#5 Power Remix  
 PDM 105 BassX#6 Sydney Youngblood  
 PDM 106 Betty Boo  
 PDM 109 Depeche Mode  
 PDM 110 DMOB Music I  
 PDM 111 DMOB Music II  
 PDM 112 DMOB Music IV(2 disks)  
 PDM 117 Flash Gordon (2 disks)  
 PDM 118 Hacktrick 'Loadsamoney'  
 PDM 120 Laurel & Hardy (2 disks)  
 PDM 128 NASP V2.0  
 PDM 131 Petshop Boys Remix#1  
 PDM 132 Petshop Boys Remix#2

## BLIT - A - COPY MKII

### THE ULTIMATE BACKUP UTILITY !!!

BACKS UP ALL KNOWN SOFTWARE-EVEN THE ONES OTHERS WON'T  
 THIS DEVICE IS PROBABLY THE MOST POWERFUL AVAILABLE  
 COMPLETE HARDWARE AND SOFTWARE PACKAGE

ONLY 29.95

(THIS DEVICE REQUIRES AN EXTERNAL DISK DRIVE)

## DISK PRICES

1-9.....£1.50  
 10-19.....£1.25  
 20+.....£1.00

FREE CATALOGUE DISK

POSTAGE AND PACKING FREE  
 ON ALL ORDERS OF 3 DISKS  
 OR MORE,UNDER 3 DISKS  
 PLEASE ADD £1.00.UK MAINLAND ONLY  
 EUROPE ADD 25PPER DISK  
 REST OF WORLD ADD 50P PER DISK  
 PLEASE NOTE  
 ALL OUR PUBLIC DOMAIN IS  
 SUPPLIED ON TOP QUALITY  
 KAO BRANDED DISKETTES

## GAMES

PDG 1 Star Trek-Final Frontier(2 disks)  
 PDG 2 Star trek (3 disks,2 drives)  
 PDG 5 Card & Board Games  
 PDG 18 Marble Slide  
 PDG 19 Destination Moonbase  
 PDG 21 Boing the Game (2 disks)  
 PDG 26 Treasure Search  
 PDG 31 Moria  
 PDG 32 Legend of Farghail  
 PDG 33 Arcadia(Breakout style game)  
 PDG 34 Dynamite Dick  
 PDG 35 Pair It  
 PDG 36 Snakes & ladders/Reversi  
 PDG 37 Super Quiz

## CLIP ART

There is a total of 13 disks in the clip  
 art range.All are in IFF Format & are  
 ideal for DTP.There are loads of  
 images to choose from,ranging from  
 fancy borders to special occasions  
 & from people to animals etc etc.

All 13 disks for only £15.00

### PACK 1

**Home Buisness Pack**  
 This 8 disk pack contains:-  
 Spreadsheet  
 Word Processor  
 Amiga Spell  
 Memo-pad  
 Inventory  
 Database etc etc  
**A must for home accounts!**  
**£10-00**

### PACK 2

**Demo Pack (10 disk pack)**  
 Budbrain 1 (2 disks)  
 Budbrain 2  
 Scoopex mental hangover  
 Crionics "neverwhere"  
 Horizon "sleeping bag"  
 Palace "pulling the trigger"  
 Quartex "substance"  
 Phenomena "interspace"  
 Decay "simpsons demo"  
**A great starter pack**  
**£11-00**

### PACK 3

**Music Pack (10 disk pack)**  
 Vision music masters  
 Crusaders "bacteria music"  
 Crack music disk  
 Jetset overload music disk  
 Raf megamix 1  
 Flash digital concert 6  
 Flashing bytes "sweet songs one"  
 Alcatraz "panic voices of energy"  
 Crusaders micro concert  
 Archaos music disk  
**£11-00**

### PACK 4

**Adult pack (10 disk pack)**  
 Sabrina,Sam Fox (2 disks)  
 Bodeans Bordello #2  
 Bodeans Bordello #3  
 Bodeans Bordello #10  
 Bodeans Movies  
 West Coast Cracker  
 BFPO #1,BFPO #2  
 Utopia #1  
**£11-00**

### PACK 5

**Music makers pack**  
 Protracker  
 Noise tracker  
 Star tracker  
 Songs disks (3 disks)  
 Insturment disks(4 disks)  
**A must for music makers**  
**£1100**

### PACK 6

**New release pack**  
 This is a 10 disk pack  
 containing all the latest  
 demos form all the best  
 groups e.g LSD,lpec Elite  
 Flashing bytes etc. etc.  
 This pack changes on a weekly  
 basis,so is kept bang up to date.  
**A must for only**  
**£12-00**

WE ACCEPT ALL MAJOR CREDIT CARDS PLEASE MAKE CHEQUES AND PO'S PAYABLE TO P.D DIRECT  
 AND SEND ORDERS TO:-

UNIT 3 DEPT ASH, RAILWAY ENTERPRISE CENTRE, SHELTON NEW ROAD,STOKE ON TRENT, ST4 7SH

# Vally PD

PO Box 15, Peterlee,  
Co Durham, SR8 1NZ.  
Tel: 091 5871195.

Just a small selection of thousands of titles in stock, send for catalogue disk for full list of PD, only 75p inc P&P! Disks are only £1.10 for under 10 disks, for 10 disks or over only 95p! Please add 50p p&p to total. You get a FREE disk over 10! Please make cheques/PO's payable to "Vally PD" or phone in your Access or Visa number (only 5 disks or over) for the quickest, cheapest, high quality service possible! Why pay more?

\*  
1 Mg!



Quality Amiga PD.

Disks as low as

# 95p

for 10 disks  
or over!



Now over 2200 disks in stock inc, Fish 1-490, Tbag 1-54, Amigos, Snag, Slipped disk, Panorama, Amicus, the Amos library 1-240 and the Amos Licenceware 1-26 as well as our own library! All are priced the same except Amos Licenceware which will be £3.50! (Standard price). Please note that EEC prices are £1.25 per disk, rest of world £1.40 per disk! Why not send your cat disk back with a 22p stamp for a FREE update?



## Greatest Demos:

- 015 Crionics mega inc. Madonna animation!
- 026 Crusaders Bacteria: Fabulous!
- 032 Technotronic demo: Amazing music!
- 026 Crusaders Bacteria: Excellent demo!
- 041 Popeye meets Beachboys: Funny!
- 047 Wrath of the Demon demo: Fab!
- 091 Puggs in Space: Quite an amusing demo!
- 112 Digital Concert VI: Excellent music disk!
- 203 Slipstream demos: inc follow me + impact.
- 367 Epic preview: Fab game preview!
- 487/488 Monty Python Lumberjack Song! (2)
- 518 Crusaders Space delenia & much more!
- 556 Elvira demo: Excellent demo of game!
- 607 Total Recall demo: Good Amie demo!
- 614 Budbrain 2: New, excellent!
- 654 Evil dead demo: This is weird!
- 674/5 Laurel + Hardy: Lonesome pine! (2)
- 764 System violator: from Anarchy!
- 765 Hysteresis demo: Excellent demo!
- 830/1 M Python: Policemans ball (2)
- 864 Phenomena Interspace: Brilliant, a must!
- 865 Beatmaster 808 state: 4 tracks!
- 872 Prodigy Tribute to the Gulf!
- 888 Pure metal coders II: Guitar: Fab!
- 890 Sleeping bag demo: Great megademol!
- 891 Chaos Rock: Superb fractals demo! \*
- 887 Good Morning Vietnam demo: Good!
- 940 Phenomena Enigma: Fantastic, get it!
- 963 Analogia Megademol: Good!
- 999 Bartman remix: Quite Good this one!
- 1000 Silents Global Trash: Superb demo!
- 1016 Hip hop pack 33: V Good!
- 1020 Technoflight megademol: Fabulous!
- 1043 Aurora megademol: Another good one!
- 1044 Light Megademol: Nice multipart demo!
- 1055/6 Laurel and Hardy animations: Great!
- 1065/6 Star Trek: Takes the micky of Strk! 2
- 1093 Plasmutex: An excellent plasma demo!
- 1105 Pendle 81: Simpsons Decay & more! \*
- 1118 Pixelated Pleasures: Very nice demo!
- 1119 Tomsoft Virtual World: An Epic, Get it!
- 1120 PMC Alpha Omega: Amazing!

## Animations & Slides:

- 001 Juggler & Walking cat: 2 classics!
- 003 Probe demo: Been on TV!
- 004 Vangelis demo: Superb demo! \*
- 005 Enterprise leaves dock: Great! \*
- 011 Newtons cradle & 2 more: Brill!
- 012 The Run Anim: Fab car chase demo! \*
- 034 Cool cougar demo: Great cartoon type! \*
- 044 Super Ham Cars: Stunning pictures!
- 050 Walker demo 1: Great! \*
- 051 Walker demo 2: Excellent! \*
- 052 CX1: Fab ray traced anim! \*
- 058 Ghostpool & Drip: Excellent anims! \*
- 059 Magician & Jogger: Good! \*
- 067 Dynamic Hires: Unbelievable quality!
- 078/9 Agatron 6+8: Ray traced pics, fab (2)
- 097 Read 3d: Mega ray traced pictures!
- 360 Stealthy Animation: Amusing Anim! \*
- 370 Colour cycling: Nice slideshow!
- 409 Fractal flight: Superb 1Mg \*
- 411 Busy bee anim: Brill ray traced anim! \*
- 492 Basketball Boing etc: good \*
- 493 Agatron anims: F15, Star trek!
- 608 Dragons Lair II (Timewarp) Fab!
- 624 Batman the Movie: Amusing anim! \*
- 692 Miner Anim: Good little Anim! \*
- 775 NWilliams Dynamic Hires: Jawdropper!
- 825 Zeus bust anim: good rotating bust! \*
- 866 Lambourghini Countach: Car pictures
- 879 Franklyn Fly: Brilliant animation! \*
- 978 Agatron30: Hyperspace+Landing \*
- 979 Agatron33: Probe & Klingon hit! \*
- 914 Agatron 12: Another fab slideshow!
- 920 Born to be free: Fab wildlife pictures!
- 1003 Pentagon+Drifters b+w fantasy!
- 1005/6 Sci-fi fantasy pics: Great (2)
- 1013 Tolkien slideshow: Nice fantasy pics!
- 1025: Rick Parks art: Fab Dpaint pics!
- 1045 Coyote II: Brill roadrunner needs 1.5 Mb!
- 1088-90 Buzzard: Fabulous but needs 2 Mb!
- 1101 German ray traced slide: Superb pics!
- 1121 Army Squirrel anim: Great anim! \*
- APD 202-3 Great slideshow various subjects!

## Music & Music Utils:

- 055 Flash music: Dance music disk!
- 060 100 64 tunes: Brill disk, a must!
- 108/9 Halloween demo: Superb! (2)
- 110/11 Quiet Riot demo: Great guitar! (2)
- 156 Soundtracker: Several versions!
- 157/158 Loads of Tracker samples! 2 disks
- 190 Games music Creator: Good!
- 245 Mididisk Lots of synth progs!
- 246 Fish 323: Casio CZ patch editor!
- 248 Amiga chart III: Black Box & Queen!
- 317 Fish 300: Realtime pitch convertor!
- 322 Perfectsound sampler & samples
- 428 TSR music 5: Technotronic type music!
- 483 Music: several progs & mid!
- 510 Burning Independence 2: Brilliant!
- 513 Depeche Mode music: Good disk!
- 534 Dmob 3: Over 4 minutes dance music!
- 562 Dead dance thrash: Metal music & pics!
- 587 Amigadeus: Mozart on Amiga!
- 589 Classix 2: Bach, Handel etc Excellent!
- 599 Audio Magic: All the soundtrackers!
- 705 Crusaders play Genesis: Brilliant disk!
- 763 Zarch music 3: Another goodun!
- 769 Prologue music: 5 good music tracks!
- 801 Get wicked/Oxygene remixes!
- 803 Groove in the heart! Dancemusical!
- 854 Digital Debussy: Clair de Lune etc: Fab!
- 894 Digital Debussy II: Arabesque etc!
- 870 Med V3.11: Latest version inc mid!
- 869 Partners in crime music 2: Lots of tunes!
- 941/2 Silents blues house: Great (2)
- 960 Patricks music: Some great tunes here!
- 961 Patricks music II: Some more great tunes
- 964 Axis music: Excellent music disk!
- 971/2 Goldfire celebrat delights! Fab! 2 disks
- 997/8 Vivaldi 4 seasons: Great Classics! (2)
- 1026-8 House music samples: 3 disks full!
- 1029/30 Made in Heaven: Good! (2)
- 1063 Talk to the trees music: Hilarious!
- Fish 356: Algorithms, midi program!
- Fish 403: Kawai K4 editor + more!
- Fish 481: Kawai K1 editor + more!

## Business & Serious:

- 057 Chet Solace: 26 utilities on this disk
- 117-20 TV graphics 4 disks for £3.50.
- 153 Jazzbench: Alternative Workbench!
- 154 Iconmania: Great to make icons!
- 228 Dope Intromaker: Make your own intros!
- 271 Rim Database: Good Database prog!
- 272 Flexibase: Easy to use database.
- 273 Home utilis: Wordwright Labelprint etc!
- 274 Analyticalc: Spreadsheet! \*
- 303-305: Scanned clipart: good stuff! 3
- 309-11 C Manual on 3 disks £2.85
- 316 Sid v1.6: Excellent directory utility!
- 448 Powerpacker 2.3b: The best cruncher!
- 489 Graphics disk: many useful progs here!
- 544 Dcopy: Good copy utility disk!
- 600 A64: Commodore 64 Emulator + progs!
- 601 Clerk: Accounts type program + Jeopard
- 616 Pascal compiler: self compiling!
- 617 Mcad: Cad design program uses Hires! \*
- 636 Clight: Excellent ray tracer program!
- 669 Master virus killer: Detects 124 viruses!
- 694 Biorhythms, Starchart etc: Good!
- 698 Exile fonts: Great coloured fonts!
- 699 Dynamite fonts: More fab fonts!
- 720 Electrocad PCB demo: Good! \*
- 805 North C v1.3: Latest C Compiler!
- 808-814 7 disks of clipart: only £6.50!
- 860 Agene Genealogy program! \*
- 861 ST emulator & utilities disk!
- 862 Spectrum emulator & utilities!
- 926-8 Deskbench/Icons/bases: 3 disks
- 957 Spectrapaint V3: Fab art program! \*
- 991 Hard drive utilities: Great programs!
- 992-5 Holy Bible: Packed on 4 disks!
- 1007 Messydos + Sid: Easy PC-Amiga!
- 1009 Hamlab: VGA pics-Amiga ham, Fab!
- 1071 PC Emulator: At last CGA graphics! \*
- Fish 375 Textplus 2.2: Wordprocessor!
- APD 132 Family history database! \*
- APD 176 Database Master: Database prog!
- APD 205 R-Draw: New paint program! \*
- Amigos 8/90 Anti flicker etc.

## Games & Leisure:

- 043 Holy Grail: Text adventure \*
  - 368/9 Star Trek: Brill 2 disk: Great!
  - 424/5 Learn & play: Fun for kids! 2
  - 426 Amigaman games pack: 10!
  - 451 Tennis game: Good shareware! \*
  - 555 Amigaman 2: Drip, Chess etc.
  - 582 Castle of Doom: Adv game!
  - 583 Flaschbier: More than 200 levels!
  - 584 Frantic Freddie: Platform game!
  - 613 Pacman 87 Retaliator & Sorry!
  - 626-30 Education pack: 5 disks £4.50.
  - 721 Battleforce: Strategy game!
  - 905 7 Tiles: Super futuresport game!
  - 909 Wizzys Quest: Aroade adventure.
  - 969 Zeus: Great block puzzle game!
  - 1011 Megaball: The best breakout game! \*
  - 1014 Tanx Amigoids Rollerpede etc!
  - 1060 Hollywood Trivia: Excellent quiz game.
  - 1106 Serene shoot em up: A great blast!
  - 1109 Llamator: Fab Jeff Minter game!
  - APD 85 Reversi + Snakes & Ladders!
  - APD 96 Pair it: Match the cards! \*
  - APD 110 Cross Fire: Great kids game
  - APD 135 Simon says & Space maths
  - APD 180/1 Dungeon Delver: 2 disks
  - APD 182/3 Pixie Kingdom: (2 disks)
  - APD 230 Amos Asteroids: 4 versions! \*
- Amos Licenceware (£3.50):**
- LPD1 Colouring book: pre school art \*
  - LPD5 Jungle Bungle: Adventure program! \*
  - LPD8 Work & Play: 3 educational games!
  - LPD10 Word Factory: Spelling aid! \*
  - LPD11 Go Getter: Good game! \*
  - LPD14 Play it safe: Safety for kids! \*
  - LPD17 Dogfight: Shoot em up game! \*
  - LPD19 X-it-50: Good game! \*
  - LPD20 Wordy: Nice wordprocessor!
  - LPD23 E.S.P.: Collect the letters!
  - LPD24 Way of Kung fu! (2) 5.50\*
  - LPD25 The Mission: Fab adventure! \*
  - LPD26 Cyad: Collect the diamonds! \*



# AMIGANUTS UNITED



169 DALE VALLEY ROAD, HOLLYBROOK, SOUTHAMPTON, SO1 6QX.

Tel enquiries: 0703 785680, Mail Order only.

DISTRIBUTORS OF THE FANTASTIC AMIGA CODERS CLUB DISKS

Here is a selection from our licenced programs, they are only available from us:

- Bug-Bash: Kill the bugs, clean up the trash in the garden.
- A great kids game.....£3.00
- Nucleus: A budget shoot-em-up that will keep you occupied for hours.....£3.00
- 1036: Amibase Professional II (v.1.2). The new additions to this database make it a must have. It includes a nice picture addition facility. (1Mb).....£3.50
- 876: Quizmaster, think you know it all? Well now you can prove it. With save and re-load facility. For 1 to 4 players. Great fun, excellent value.....£3.00
- 877: 1 Across 2 Down. A fully fledged crossword program. (Data disk No: 1 is supplied free!). For only £5.00. Data disks 2, 3 and 4 are now ready at £2.00 each.
- 1038: Super Amidash. Do you remember that good old Commodore 64 game Boulderdash? Well here is your chance to have that fun again 1Mb.....£3.00
- 1068: MOD Processor v1.92. make picture and/or music progs, adjust pic height/width. This version will load the new 8 channel octamed music and is excellent!.....£3.50
- 1075: Intuimenu. The easiest way to run all your programs.....£3.00
- By Nicholas Lewis.....£3.00
- 1077: Clear. A very good, (but mind-bogglingly hard), game from PH Software.....£3.00
- 1083: Copper Writer/Screen Designer. By Frank Tout. (For programmers only).....£3.00
- 1088: Weird in Edgways. This is a good puzzle game.....£3.00
- By Chris Banks 1Mb.....£3.00
- 1100: School Timetable Creator. (Print your timetable).....£3.00
- By Keith Grant. 1Mb.....£3.00
- 1102: The Sprite Designer. A good way to draw/save sprites. By Frank Tout.....£3.00
- 1106: The Block Designer. Use with disk 1083 and design 16 x 16 pixel squares.....£3.00

Listed below are the latest additions to our public domain & shareware section

- 1101: Darkstaff. A spectrum emulated text adventure game. (Not bad).....£1.50
- 1103: A very special 4 disk animation from the famous Tobias Richter. 5Mb.....£6.00
- 1104: Scum Haters. Get those baddies! A good fun game by Brazzle Atkins.....£2.00
- 1105: Reincarnation of Sgt. Pepper. A two disk music/pic extravaganza 1Mb.....£3.00
- 1111: PCQ Pascal Front End, (Assembler). This is a must for PCQ fans.....£2.00

Many new programs have arrived, but there is no space to list them all!

Into coding? - Want to learn? The Amiga Coders Club is for you! ACC 1-4 is the first four compressed issues of an excellent series for coders, even if you are new to the Amiga. If you want to learn Assembly, using DevPac, (or our own new ACC special assembler disk), this is the club for you! ACC 1-4 (compressed) £1.50. The Amiga Coders Club disks are packed with source, hints, tips, advice from many of the well known coders that are on the Amiga scene today. Issue numbers 5-15 are now available. Please note, (excluding the compressed introductory disk (ACC 1-4), and no. 12) the price for each issue of the ACC disks is only £3.00. ACC 12 is our birthday issue, it is a 2 disk set, and therefore the price is £6.00. Amiga Coders Club Special! Here is a low priced assembler package for all you coders out there in Amigaland. By Mark Meany & Steve Marshall £5.00

NO MORE WAITING! SUBSCRIBE TO THE AMIGA CODERS CLUB NOW!

If you would like to get hold of the Amiga Coders Club disks as soon as they are published, why not send £33.00 and ask to go on the ACC mailing list now? We will send you each issue as soon as it is ready.

(Applies to issue 15 onwards. Issues released prior to ACC 15 must be purchased separately.)

AMIGANUTS ARE PROUD TO ANNOUNCE THAT WE ARE NOW THE EUROPEAN DISTRIBUTORS FOR MERLIN SOFTWARE PROGRAMS, WHICH INCLUDE THE WORLD FAMOUS T.BAG DISKS.

T.BAG DISK NUMBERS 1 TO 49 ARE £2.00 EACH

£3.00 EACH FROM ISSUE 50 ONWARD.

SUBSCRIBE TO THE WORLD FAMOUS TAMPA BAY AMIGA GROUP DISK OF THE MONTH SERIES.

If you would like to take out a year's subscription for the T. Bag disks, (applies to issue 50 onward), simply send £33.00 and we will send you each issue well in advance of them becoming available from any other supplier. (Issues released prior to T. Bag 50 must be purchased separately @ £2.00 each).



# LOOK



THE EXCELLENT (1Mb) EIGHT OR FOUR CHANNEL MIDI COMPATIBLE Octamed v1

AMIGANUTS hold the worldwide copyright to this program and it will not be available through any other stockist.

You can purchase this great program for only £10.00 within Europe. (£15.00 for non-European). The price includes return post and packing. Payment in pounds sterling only, if ordering from overseas, send a bankers order/eurocheque etc. (Credit card orders will not be accepted).

A full instruction manual for this program will become available later, but due to the high costs involved, it will be quite expensive!

Free disks + free progs + free membership over a thousand detailed progs plus some games to play, on the main catalogue disk for only £1.00  
Main catalogue disk sent is "FREE" with orders above £15.00

- please remember to ask for your free copy if you send an order above £15.00 as we tend to forget.

Prices quoted include return post and packing. Make cheques etc payable to: Amiganuts United (no credit card orders).

Also available is the 1991 update to our main catalogue for only £1.00. (The update contains only the 1991 additions to the library).

Please note that we are closed from 18th to 26th August and no orders will be dealt with during these dates.

Many customers keep asking us why we will not accept credit cards, the simple answer is that we do not like encouraging young people to get into debt!!

## LEGAL NOTICE

Postal PD/Track Computer Systems have advertised our copyrighted programs, (OCTAMED - QUIZMASTER etc.) and PD Soft are advertising Amibase Professional. These programs are not legally available from them, or any other stockist.

**MORE ARNIE CLIPS**

17 Bit, Disk 1146



After reviewing a couple of sample disks last month featuring some of Steve Wright's humorous versions of Arnold Schwarzenegger, here is yet another one! The disk plays two clips over a set of pictures digitised from *The Terminator*. If you're a Radio One fan or you want a quick laugh then it's worth having a look.

**KGB MEGADEMO**

PD Soft, Disks 1618 and 1619

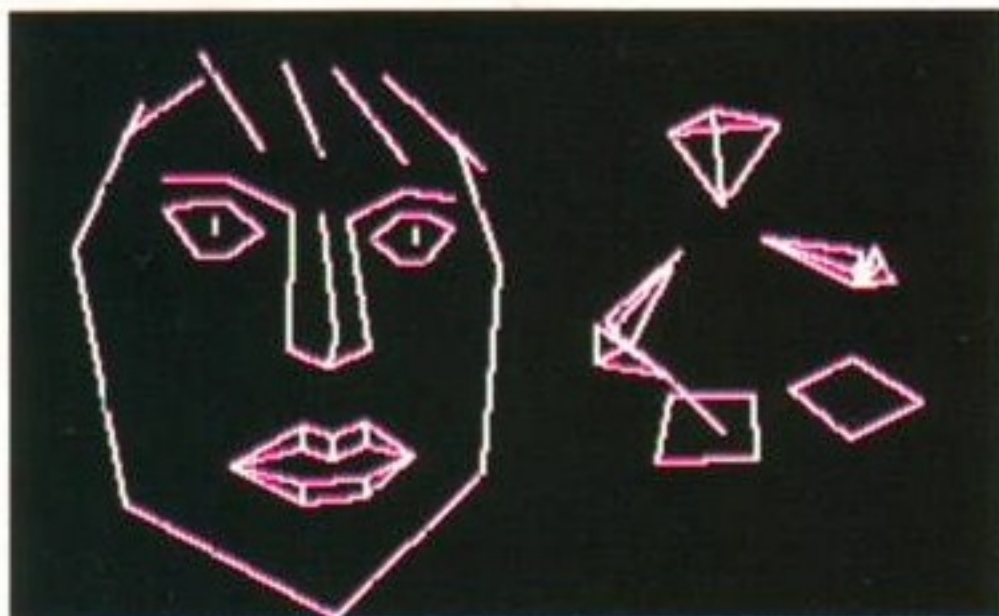

I know that megademos are usually pretty repetitive and boring, but this one is put together with a touch more class than most. After a strange test-card intro, the demo continues with some superb wire-frame images and flash-frame effects over a groovy acid track. Sound dull? Well have a look for yourself and you'll be impressed.

**ANIMATIONS**

17 Bit, Disk 1095

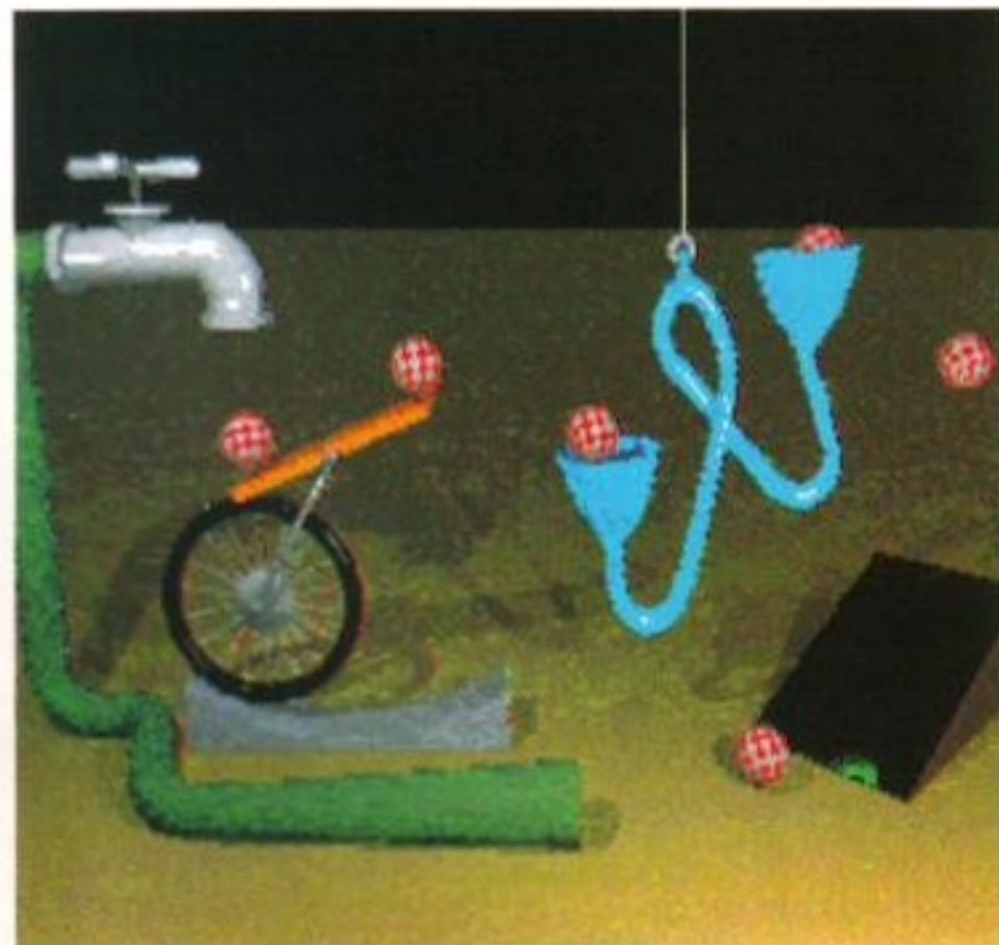

Featured on this disk are three ray-traced animations. Two of them, *Bird* and *Radio II*, you may have seen before since they have both been featured in previous editions of Demo Zone. The other animation is a strange clip featuring balls flying out of a tap and over various obstacles. Ah yes! We like our weird animations to be *very weird* around here!

**MORE CLASSY ANIMATIONS VOL. 5**

NBS, Disk D613

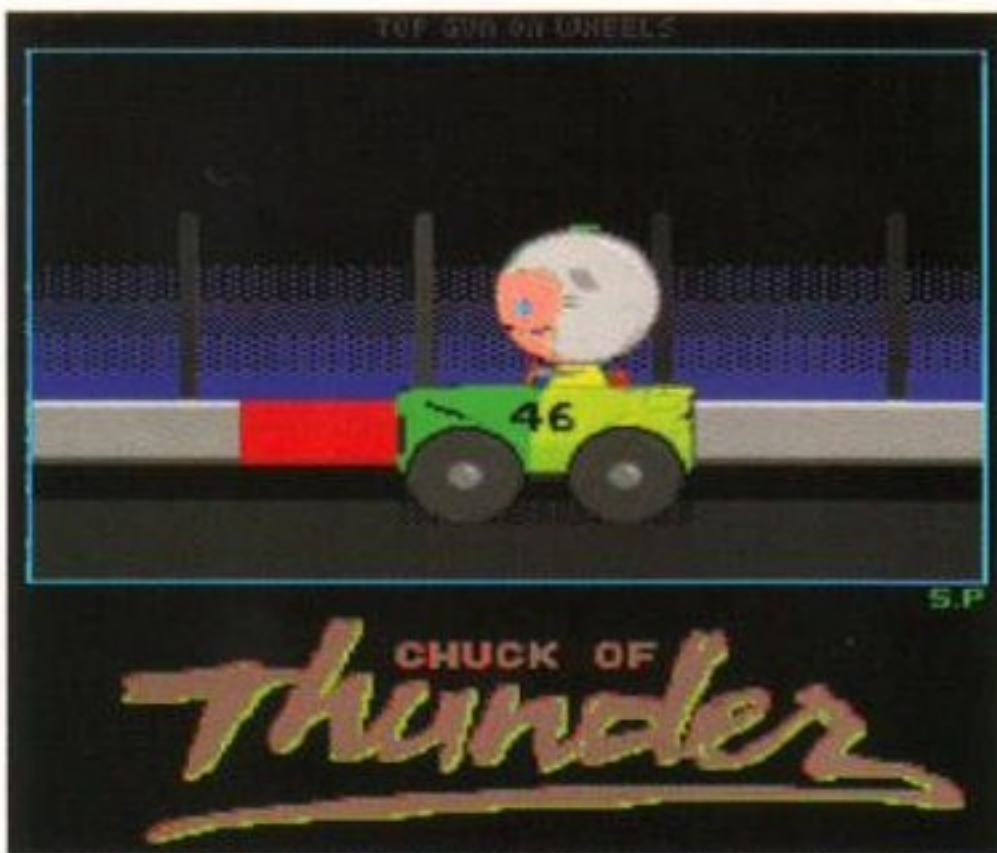

Yes he's back! That cute little fella called Chuck has returned in some more short but entertaining little cartoons. The subject matter ranges from skiing, to *Days of Thunder* through to intense violence. Also included is another superb rendition of one of the torture screens from the *Creatures* game.

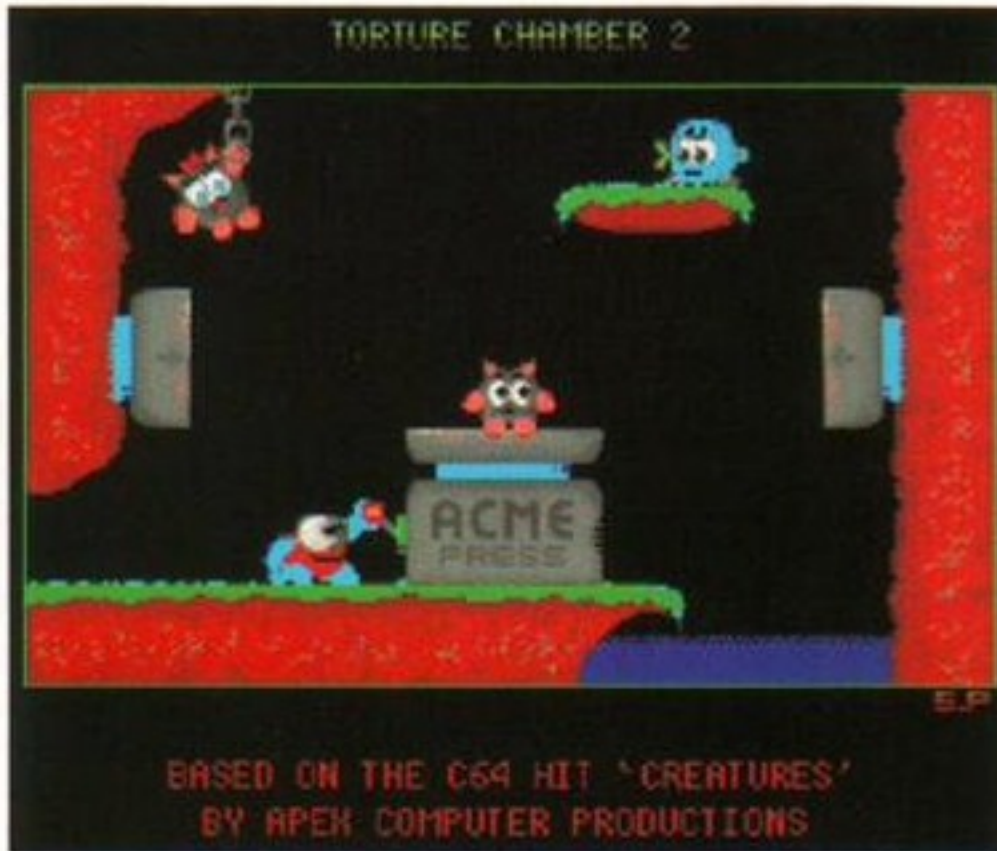

**3D ANIMATIONS**

17 Bit, Disk 1188

This disk contains two little ray-traced animations. The first clip is pretty dull, featuring a spring with a ball bouncing inside it (holding down the mouse button causes a nice strobe effect though). The second piece is pretty sweet though, featuring two traffic cones juggling three trucks between them. Sound weird? It is!

**NOTECH DEMO**

17 Bit, Disk 1149



This is a pretty standard whizzy demo, but the graphics are quite pretty! The main feature is the powerful dance-music backing, which will have your toe tapping along to the beat. All techno-freaks have a look and decide for yourself.

**THE DATING GAME**

Public House, Disks 1103 and 1104



No issue of Demo Zone would be complete without an Eric Schwartz animation. This one has to be loaded from Workbench and it takes a pretty long time to get going. Still, it's worth being patient, since the cartoon is an excellent *Tom and Jerry*-style farce, featuring a rather harassed frog on route to his dream date. If you haven't seen a Schwartz cartoon before, then this little gem is a pretty good place to start.



**PD TOP TEN DEMOS**

LOW ALCOHOL PUBLIC DOMAIN

- 1) ProTracker V1.1
- 2) Demon Games Vol 6
- 3) ZeroVirus III
- 4) Three Player Tetris
- 5) European Charts disk
- 6) Tobias Richter Star Trek
- 7) Kefrens Utilities 4
- 8) Messydos
- 9) WellTrix
- 10) MCP V0.9

**CONTACT:**

**Amiganuts United:** 169 Dale Valley Road, Hollybrook, Southampton SO1 6QX. Tel: 0703 785680

**NBS:** 132 Gunville Road, Isle of Wight PO30 5LH. Tel: 0983 529594

**PD Soft:** 1 Bryant Avenue, Southend, Essex SS1 2YD. Tel: 0702 612259

**Public House PD:** Flat 85a Woodfield Road, Benfleet, Essex SS7 2ES

**17 Bit Software:** PO Box 97, Wakefield WF1 1XX. Tel: 0924 366982

**The Disk:** 6 Stubbing Brink, Hebden Bridge, West Yorkshire HX7 6LR. Tel: 0422 844215

# FREE!

## FREE DISKS FREE CATALOGUE FREE DISKS FREE CATALOGUE

### BUSINESS

- BU1058 VC Spread Sheet Calculator
- BU1059 RIM V5.0
- BU1188 Bankn V1.5
- BU1288 UEDIT
- BU1344 Visicalc
- BU1348 amicron V2.4
- CO1067 4 Comms Programmes V1.34
- Co1175 Star term V3
- CO5265 Access V1.3
- ED3052 German Language
- ED3053 Draw Map
- ED3054 EVO
- ED3056 World Dbase

### GAMES

- GA7007 The Prisoner Plague
- Ga7064 Deep Sky V5
- GA7073 Backgammon & More
- GA7076 Moria
- GA7077 Empire
- Ga7078 Amoeba Invaders
- GA7083 Cosmoroids
- GA7088 Shanghai
- Ga7089 Tunnel Vision
- GA7098 Car
- GA7099 Dragon Cave
- GA7103 Tennis
- GA7105 The Holy Grail Adventure
- GA7106 The Golden Fleec Adventure
- GA7107 Callisto
- GA7171 Laser Strike
- GA7175 Gravity V2.2
- GA7186 Escpae from Jovi
- GA7204 Stone Age V1.2
- GA7323 Chinachallenge
- GA7338 Snakepit
- GA7204 Stone Age

### GRAPHICS

- GR2026 Ham Pictures
- GR2027 Boris Vallejo vol3
- GR2049 Nasa Pictures
- GR2110 Graphic Utilities
- GR2111 Amiga Mcad
- GR2112 lff to Pieces Jigsaw Program
- GR2164 Sky Paint
- GR2325 Amigafox
- GR2349 Fonts

### MUSIC

- MU8037 POP TUNES
- MU8043 Technotronic Music Disk
- MU8047 TSB The special Brothers
- MU8050 Crocketts Theme
- MU8206 Oktalyzer
- MU8216 Sonix Scores Player
- MU8218 Soundtracker Instruments

### UTILITIES

- UT4001 Vlabel
- UT4005 DME
- UT4006 Word Count
- UT4011 Geotime
- UT4016 Tag The BBS
- UT4022 Banner
- UT4023 Compress
- UT4045 Amcat
- UT4114 Mandelbrot Explorer
- UT4115 Aco Face Maker
- UT4135 Sozobon C
- UT4146 P2C V1
- UT4159 Text Reader
- UT4136 Crossdos

### PRICES

**£2.49 PER DISK  
+ £1.95 P&P**

**Akore Shareware brings you the most comprehensive range of shareware and P.D. in the U.K.**

**We are now offering you a FREE copy of our 96 page catalogue plus a FREE Disk with your next purchase.**



Separate payments must be made to authors where requested, if shareware disks are found useful. Public Domain disks require no further payment.

Please rush me my FREE catalogue and disk to: AM/01

Name

Address



Postcode  Tel:

The disks I require at £2.49 (+£1.95 P&P)each are:

code	price	code	price	code	price
					TOTAL (inc p&p)

To order post to  
Freepost, Akore,  
Nottingham, NG1  
1BR or telephone

**0800 252221**

**99p**  **Sagittarian PD**  **99p**

99p per disk (or 59p per disk if you supply a blank). Add 50p P&P per order.  
Overseas orders please add £2 per order. CATALOGUE disk 70p  
(including tips on buying video equipment, plus hand drawn portraits and digitised pictures.  
Overseas please add £1).  
For a membership fee of £5, you can buy disks for 80p each (40p if you supply a blank) and have the same percentage discount on future prices.

**UTL36** - Antiflicker (with English documentation), Biorhythms, Messy DOS, Noclick (stops drives clicking), Spectrum Emulator, Better Speech (improves pronunciation of some words), Disk Salvage, Kick RES (allows you to use a kickstart disk as on the A1000).  
**GAM14** - Technoball, playable demo of this TLK games release. A breakout/snooker crossover with 4 bats, corner pockets and various options.  
**GAM15** - Air traffic control, Star Trek Trivia, Monopoly.  
**GRA12** - Dr Who digitised slideshow 1. Featuring all 7 doctors.  
**GRA13** - Dr Who digitised slideshow 2. Featuring the 4 most recent doctors.  
**GRA14** - Star Trek: The Next Generation digitised slideshow 1.  
**GRA15** - Star Trek: The Next Generation digitised slideshow 2.  
**GRA17** - Blakes Seven "Stardrive" digitised slideshow from this final series episode.

**GRA23** - Doctor Who Gallifreyan slideshow from the Doctor's home planet.  
**UT131** - Includes ST EMULATOR that runs loads of non crunched software (needs 2 drives). Powerpacker v2.36. Noisetracker v2.0, Virus X4.4.  
**FISH337** - The C Manual (1 disk archived or 3 disks unarchived for single drive users, please state).  
**FISH344** - ROM Kernel Reference Manual Companion.  
**FISH Disks 95, 110, 143, 161, 295, 328, 340 and 347 also in stock.**  
**DEM74** - Cerberus "Copper Scroll" Demo, Scoopex "Glenzvector" demo, Concept's New Intro, Anarchy's "Shape Change" Demo, Coma "Werks" Demo, Anthrox "Bobby The Ball" Demo with a storyline.  
**DEM75** - Magnetic Fields Hysteresis Demo, Anarchy Madness Demo Part II.  
**UTL26** - (2 disks). Video Applications. Numerous programs for use with a Genlock.

Technical Help: Phone or write with your problems about the Amiga - 50p per answer.

Please address mail to: Paul Brown (AF8), 104 Wood Street, London, E17 3HX.

Telephone: 081 509 9565, International +44 8 15 09 96 56

Cheques/P.O.'s/Eurocheques/Bankers Drafts payable to: P.A. Brown.

**MAKE YOUR AMIGA EARN!**

Yes, making money with your AMIGA becomes incidental when you know how! Your AMIGA is, if only you knew it, a gold mine. The size and make is irrelevant. Make the initial effort NOW by starting your own HOME BASED BUSINESS.

*This may be the most important move you will ever make!*

**REMEMBER:** You'll never get rich by digging someone else's "ditch".

Anyone in the country, including YOU, can become very rich in a relatively short period of time just by doing a few basic things! It's more rewarding than playing games. The benefits are many and varied. Full or part time.

For FREE DETAILS SEND S.A.E. to:



**Home Based Business.**

31 Pilton Place, King and Queen Street, AF26  
Walworth, London, SE17 1DR.

**LIVE IN LEEDS?**

See local press for details!

Unlike the majority of advertisers in this magazine, we are dedicated to serving the needs of our local customers.

They know we offer great advice, service and deals on all things Amiga. Our city centre showroom is packed with the latest software and hardware covering DTP, GRAPHICS, VIDEO, MIDI & BUSINESS applications plus those 'hard to find' items like PC Emulators, Scanners, DIGITIZERS, GENLOCKS, REPLACEMENT DRIVES & MEMORY UPGRADES.

Our local 'Price Match' means you won't have to sacrifice service to save a few pounds and we often have special offers available only to personal callers or through our adverts in the Y.E.P. - Hence 'See local press for details'!

So even if you normally shop somewhere else, or prefer mail order, come in to see us. We think you'll be surprised at what we can offer!



**MIDITECH**

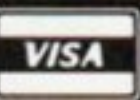

54, The Balcony, The Merrion Centre,  
Leeds LS2 8NG Tel (0532) 446520

We are open 9-30 to 6.00 Mon-Fri 9.00-5.30 Sat  
Est. 1988



Can you afford *not* to join?

**THE** *Amiga* **CLUB**

**PUBLIC DOMAIN**

**CLUB**

Yes that's right, you can now get Amiga PD for an amazing 39p per disk (Free if you supply the disk), once you have joined our friendly, fast growing and extremely popular Amiga PD Club. It must surely be the Public Domain buyers dream come true!

Lifetime membership to the club costs only £19.95. Much of this, however, will go straight back into the club to provide you with an even better service. Members will be able to choose as many PD titles as they like from our detailed catalogue disks, listing many of the Classic and Latest titles. We will bring you the very best in Demos, Utilities, Music, Art, Business, Animation, Games, Slides and much more. Just send us the blank disks & return postage and we will despatch your order to you the same day. It just couldn't be easier. As an added bonus, members not wishing to supply their own disks - don't have to. We will send your order on our own high quality disks for just 39p per title. We can't say fairer than that!

Members will also enjoy many other benefits including:

- ★ Many new titles to choose from every month!
- ★ Massive discounts on other Amiga Products!
- ★ All catalogue disks are constantly updated and are available FREE!
- ★ Superb disk magazine, FREE every month. (News, Reviews, Competitions, Letters, Classifieds and much more!)
- ★ A FREE games compilation to welcome all new members! A FREE mystery gift worth £14.95!
- ★ No minimum or maximum order!
- ★ Members can even request titles that we don't have at no extra cost!

Membership is usually priced at £29.95 a year, so apply now and take full advantage of this extra special offer. Remember, you can have LIFETIME membership for an incredible £19.95! Even your first order could save you £££s!

To become a member, simply fill out the form below and send with a Cheque/Postal Order to:

**P.A.S. Enterprises, Amiga PD Club, 3 St. Johns Walk,  
St. Ives, Cornwall TR26 2JJ, England.**

Join now. We promise you will not be disappointed

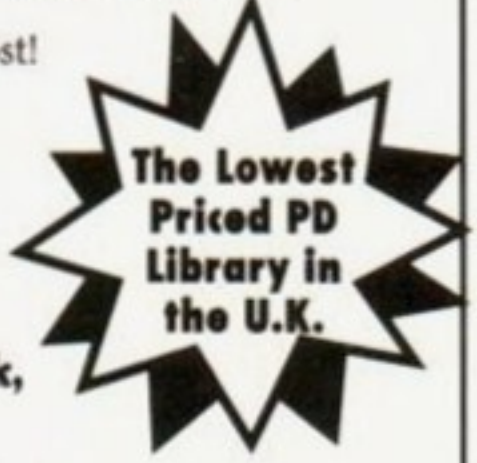

Please enrol me as a member of the AMIGA PD CLUB and rush me my members pack and membership number. I enclose a Cheque/Postal Order for £19.95 payable to P.A.S. Enterprises.

Name..... Address.....

Postcode..... Telephone.....

Why buy an ordinary sound sampler - when you can buy a recording studio?

**TECHNOSOUND Turbo**  
SOUND SAMPLING SYSTEM FOR THE  
**AMIGA**



- ★ SONG SEQUENCER
- ★ MIDI SEQUENCER
- ★ VARIABLE DIGITAL DELAY
- ★ VARIABLE CUT BUFFER
- ★ FULL MULTITASKING
- ★ 57 RECORDED SAMPLES

- ★ STATE OF THE ART TRUE STEREO CARTRIDGE
- ★ OVER 100 INTERACTIVE FUNCTIONS
- ★ SIMPLE TO USE TUTORIAL AND USER GUIDE
- ★ STUNNING REAL TIME EFFECTS INCLUDE:- Echo - Reverb - Hall - Voice Synthesis - Phaser and Vibrato.
- ★ EXTENSIVE EDITING AND LOOPING FACILITIES

**UPGRADE AVAILABLE  
TO EXISTING USERS  
FOR ONLY**

**£6.00 + £1.00 P&P**

**NEW  
DIMENSIONS**

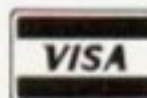

BROOKLANDS HOUSE  
BRYNGWYN, RAGLAN  
GWENT NP5 2AA  
0291-690933/690901

**£35.99**

+ £1.50 POST AND PACKING





**ONLY  
£1  
PER DISK**

Buy six disks or more and choose another FREE!  
Branded blank disks only 55p each

**NRG PD. PO BOX 2290, KINGS  
NORTON, BIRMINGHAM,  
B38 8RP. TEL: 021 486 1195**

UK postage add 65p per order.

**BUSINESS**

NB101 RIM DATABASE Complex  
NB102 WORDWRIGHT Wordpro + Check  
NB103 AMIBASE Good Database  
NB104 JOURNAL Bank account record  
NB105 ANALYTICAL Spreadsheet

**DEMOS**

ND111 ALF DEMO Hear Alf rap!  
ND112 ADDAMS FAMILY DEMO  
ND148 APPELUS ANIMATION (1Meg)  
ND226 AMY VS WALKER (1Meg) Ace!  
ND114 BATMAN Brill movie sequence  
ND115 BUDBRAIN DEMO (2 disks)  
ND116 BUDBRAIN 2 Madonna murderer!  
ND149 BASKET BALL ANIM (1Meg)  
ND225 BOOK KNIGHT ANIM (1Meg)  
ND151 CHUCK ANIMS Funny cartoons  
ND118 CAR & UNICYCLE Brill anim  
ND119 ENTERPRISE LEAVING DOCK!  
ND120 EVIL DEAD DEMO Creepy stuff!  
ND121 EDUCATION OF COOL COUGAR  
ND123 FRAXION FUTURE VISIONS  
ND125 FILLIT THE FISH DEMO  
ND126 GARFIELD DEMO Cool Cat!  
ND127 IRAQ DEMO (1Meg) Great!  
ND128 KYLIE DEMO (2 disks) Cor!  
ND129 KYLIE LOCOMOTION Yummy!  
ND130 LAUREL & HARDY (2 disks)  
ND223 MAGICIAN & JOGGER (1Meg)  
ND132 MADONNA DEMO 2 (2 disks)  
ND133 MONTY PYTHON (2 disks)  
ND134 NEIGHBOURS Hilarious Pics!  
ND146 PHENOMENA ENIGMA (1Meg)  
ND224 PUGGS IN SPACE Funny demo  
ND137 ROBOCOP DEMO 5s to comply!  
ND150 STEALTHY ANIMS \*3 (1Meg)  
ND139 SPACE FIGHTER (1Meg)  
ND140 STAR TREK ANIMATIONS V17  
ND141 SCULPT 3D ANIMS inc Newton  
ND145 SIMPSONS DEMO (1Meg) Brill!  
ND234 STEALTHY/COMA DEMO (1Meg)  
ND142 TEENAGE MUTANT TURTLES!  
ND143 TOTAL RECALL Mars Mania!  
ND144 VIZ SLIDESHOW Fat Slags etc  
ND152 WINGS ANIM (1Meg) long anim

**MUSIC**

NM151 AMAZING TUNES 2 (3 disks, 1Meg)  
NM152 BETTY BOO Terrific Tunes!  
NM154 DIGITAL CONCERT 3  
NM155 DIGITAL CONCERT 4 Leila K etc

NM157 DIGITAL CONCERT 6 House Music  
NM228 EQUIMANIA II Super Music!  
NM159 GAMES MUSIC CREATOR  
NM160 GROOVE IS IN THE HEART!  
NM161 GENESIS Phil & the rest!  
NM227 GET TO THE SAFEHOUSE Good!  
NM163 IROM MAIDEN Rock! Rock! Rock!  
NM175 MYSTERONS SOUNDS DISK  
ND164 MADONNA VOGUE (4 disks)  
ND165 MADONNA HANKY PANKY!  
NM166 MICHAEL JACKSON BADI AAWWI  
NM167 MIAMI VICE REMIX hot stuff!  
NM168 PET SHOP BOYS hi NRG!  
NM169 PINK FLOYD THE WALL Classic!  
NM170 QUEEN FLASH (2 disks)  
NM174 SYNTHETIX MUSIC Lovely!  
NM171 TECHNOTRONIC MEGAMIX  
NM172 VANGELIS DEMO (1Meg)  
NM173 WALK THIS WAY

**UTILITIES**

NU181 BIORHYTHMS Emotions monitor  
NU182 INTROMAKER Create demos!  
NU184 TV GRAFFIX (2 disks) Fonts  
NU187 MASTER VIRUS KILLER V2.1  
NU185 NOISETRACKER 2.0 MIDI  
NU186 FUTURE COMPOSER Make music!  
NU230 SPECTRUM EMULATOR Nostalgia

**GAMES**

NG192 ARCADE GAMES Tons of fun!  
NG195 BIONIX Fast shoot em up!  
NG196 BLIZZARD Shoot em up!  
NG197 COLLOSUS ADVENTURE GAME  
NG198 EAT MINE Super fun!  
NG199 FRANTIC FREDDY! Platform fun  
NG200 GRAVATTACK  
NG202 JUMPY Arcade fun  
NG203 MONOPOLY Brill classic!  
NG204 MEGA GAMES 2 (2 disks)  
NG205 MARBLE SLIDE Madness!  
NG217 MEGABALL arkanoid clone!  
NG220 MENTAL IMAGE GAMES Buy it!  
NG207 NEW STAR TREK GAME (2 disks)  
NG208 PACMAN Gobble Gobble!  
NG209 PSEUDO COP Arcade action  
NG210 QUIZ MASTER Brain food!  
NG219 RINGS OF ZON (1Meg)  
NG212 SNAKE PIT  
NG218 SEVEN TILES Great game!  
NG213 2 PLAYER SOCCER LEAGUE  
NG215 THE HOLY GRAIL Adventure

**PCS INTERNATIONAL PD**

The Northwests Biggest PD Library  
FREEPOST WN5157F HINDLEY, WIGAN, LANCS, WN2 3BR

**0942 521577**

**NEW IN SCOPE PD**

The UK's third biggest supplier of Amos Licenseware,  
now called Deja Vu Professional Licensed Software  
NOW SUPPLIED WITH ITS OWN LABELS

**NEW AMOS PD**

APD 198 Bombs of Baghdad  
APD 199 Amos Progs 14  
APD 200 Dungeon Master  
APD 201 Slideshow  
APD 202 Slideshow Disk B  
APD 203 Xenomorphs Fractal Demo  
APD 204 Robots Mega Demo  
APD 205 R-Draw 1.48  
APD 206 Depeche Mode  
APD 207 Madness Week Demo  
APD 208 Madness Week Disk B  
APD 209 Frantix Demo 1  
APD 210 Frantix Disk B  
APD 211 Boris Vallego Slides  
APD 212 Boris Disk B  
APD 213 Dreamers 5.1  
APD 214 Hanissis Five  
APD 215 Fractals Workshop  
APD 216 Frantix Megademo 2  
APD 217 Frantix Disk B  
APD 218 Amos Progs 15  
APD 219 Jigmania Data Disk 2  
APD 220 Jigmania Data Disk 3  
APD 221 Amos Bingo  
APD 222 Steves Samples 1  
APD 223 Steves Samples 2  
APD 224 Steves Samples 3  
APD 225 Steves Samples 4  
APD 226 Steves Samples 5  
APD 227 Welcome & Robots Demo  
APD 228 Welcome Disk 2  
APD 229 Amos Multipaint  
APD 230 Amos Asteroids  
APD 231 Antok  
APD 232 Music 35  
APD 233 Amos Progs 16  
APD 234 Amos Text  
APD 235 Music 36  
APD 236 Music 37  
APD 237 Shapes  
APD 238 Amos Image Manipulator  
APD 239 Frantix Music 1  
APD 240 Frantix Disk B  
QUICKBENCH V1, V2, V3  
WORKBENCH REPLACEMENT  
PUBLIC DOMAIN ENCYCLOPEDIA FOR BEGINNERS NO NEED FOR  
CONTAINING A LISTING OF PUBLIC EXTERNAL DRIVES PLEASE STATE  
DOMAIN SINCE 1987 NOW AVAILABLE MEMORY SIZE WHEN ORDERING

ALSO AVAILABLE FROM US:  
Amos, Amicus, Amigos, Fish, TBag, SD-Disk,  
Snag and now Scope. Our catalogue disk now  
contains over 2000 disks and Sid V1.6 and M.V.K  
2.0 only £1.00

**T-BAG 1-54  
NOW IN STOCK**

**COMPETITION RESULTS NEXT MONTH  
EUROPE ADD 25p R.O.T.W. ADD 60p**

**DemX**

Public Domain Library & Mail Order Company

**Blank Disks:**

1- 19 .....30p ea.\*  
20+ .....28p ea.\*

\*Please add £1.00 P & P.

**Memory Upgrades:**

0.5 Meg with Clock.....£24.99\*  
0.5 Meg no Clock.....£22.99\*

\*Please add 50p P&P

**PD Competition!!!  
What you have to Do**

Simple, we want you to write either a Demo, Animation, Intro or a Music Disk and send it in to us at the address below. All entries must be received by 31 October 1991.

We will judge the entries in the 4 separate categories. The winners of each category will all receive £25!!!

We will then enter the 4 winning entries into another competition, the winner of which will receive a further £100, making a total of £125 for the overall winner!!!

Please write which category you wish to enter on the Disk Label.  
Also remember to write your name and address on the Disk Label.

**Conditions**

1. There is no limit to the number of times a person or group may enter.
2. All Entrants must agree to indemnify both DemX and Future Publishing from prosecution due to any copyright infringements.
3. Entry into this competition is deemed as an acceptance of these conditions.
4. All entries must be written for the competition, no previously released Public Domain disks will be entered.
5. Disks will be returned if accompanied by an S.A.E.
6. All entries will be placed in the DemX Public Domain Library
7. The Judges decision is final.
8. No correspondence will be entered into.

**DemX**

Dept (AF), 61 Derby Road, Hilton, Derbyshire, DE6 5FP.

**Telephone:  
(0283) 734626  
For a free Catalogue Disk.**

# EVEN HOUDINI COULD NOT CONJURE UP THESE PRICES

**WE'VE STACKED THE DECK IN YOUR FAVOUR**



You will not have to dig deep into your pocket to afford this product. RE-INK, the product taking the ribbon world by storm. One can will Re-Ink your fabric ribbon up to 50 times.

Available NOW only

**£12.95**



Why not **CLUB** together and take advantage of some superb offers we have. Here's a few accessories to entice you.

BANX Stackable Boxes .....£8.95  
 100 Cap 3.5" lockable box .....£8.95  
 Pack of 5 3.5" library cases .....£4.95  
 Deluxe Mouse Mats.....£2.95  
 Head Cleaner.....£2.95  
 Universal Printer Stand.....£6.95  
 Roll of 100 3.5" labels.....£12.95

plus lots lots more  
 (Ring for free catalogue)



**HOUDINI'S SPECIAL OFFER**  
**400 DS/DD 3.5"**  
**PLUS 4 x 100 capacity lockable boxes**  
**only £139.95**



**DOUBLE SIDED, DOUBLE DENSITY 880K**

You will not be **HEART** broken by these prices, and you'll love the quality.

50 for only.....£26.95  
 100 for only.....£42.95  
 200 for only.....£64.99

Supplied with labels and unconditional lifetime guarantee

**YOU CANNOT BUY BETTER**



**HIGH DENSITY 1.44MB 3.5"**

A **DIAMOND** amongst diskettes, superb quality, 100% certified, tested.

25 for only.....£29.95  
 50 for only.....£39.95  
 100 for only.....£62.95

Supplied with labels and unconditional lifetime guarantee

**JOKER** No **JOKING** a  
 100 Capacity  
 3.5" or 5.25"  
 lockable box only

**£3.50\***

\*only if purchased with disks

**JOKER**

**ALL DISKETTES SUPPLIED BY US ARE 100% CERTIFIED AND GUARANTEED. OUR PROMISE IS SIMPLE, SATISFACTION OR MONEY BACK.**

**The price you see is the price you pay**

Send in this ad and receive an extra £3 off your DD disks

Send in this ad and receive 1 disk box absolutely FREE when you buy 200 disks or more.



**MAJIC COMPUTER**

**MEDIA SUPPLIES**

**18 CRESCENT WAY, FARNBOROUGH, KENT BR6 9LS. TELESALES HOTLINE: 0689-861400**

(All prices quoted are inclusive of VAT and carriage UK Mainland only) E. & O.E.

EDUCATIONAL & GOVERNMENT ORDERS WELCOME

Majic Media is a trading division of MD Office Supplies



# If you have an Amiga, **You need this!**

● **Easy-access introductions** will help you to get creative

● **Software and hardware guides** show you what to buy

● **Interesting features** can tell you more about your machine

● **Public Domain explained** so you can get free software

● **Workbench 'serious' advice** solves your problems

● **Gamebusters games advice** helps you lick the sticky bits

**PLUS**  
two disks packed with incredibly useful software for only £4 more!

**All these topics covered - and more:**

Accelerator Cards, Accounts, Agnus, AMAS, A-Max, Amiga - launch of, history of, AmigaBASIC, AMOS, Animation, Assembler, Bad disks, Basic, BBC emulator, Beginners' Guides, Bootblocks, Bulletin Boards, C, C64 emulator, CAD, Scanners, CDTV, Chips: Inside the Amiga, CLI commands, Clock, Commodore's history, Comms, Copper Lists, Daisywheel Printers, Databases, Datalink cables, Deluxe Paint, Desktop Publishing, Desktop Video, Directories, Disk copying, DiskDoctor, Digitisers, Disk Drives, Display modes, Dot Matrix Printers, DTP, ECS chip upgrade, Fax machine emulator, Fatter Agnus, Files, Fonts, Forth, Fortran, Frame Grabbers, Gamebusters, Genlocks, Graphics, Graphics tablets, Guru Meditation, HAM, Hard Drives, Hardware, Hints and Tips, IFF explained, Inkjet Printers, Interlace flicker, Intuition, Joysticks, Keyboards, Kickstart, Laser Printers, Lazarus explained, Logo, Macintosh emulator, Modelling in 3D, Monitors, Multimedia, Music, Music for Games, Music X, NotePad, Null modem cables, On-line games, Paint packages, Pascal, Paula, PC Bridgeboards, PC emulators, Preferences, Printer Drivers, Printer advice, Programming Languages, Protecting data, Protex, Public Domain, RAM disks, RAM expansions, Ray-tracing, Rude messages, Samplers, Scanners, Scoring, Screen-grabbing, Self-booting disks, Setting the time when booting, Sequencers, Spectrum emulator, Spreadsheets, Start-up Sequence, Superbase, Talking Amigas, Teletext emulator, Thermal Printers, Three-dimensional art packages, Trackballs, TV modulators, User groups, Video Digitisers, Video production, Video titling, Viruses, Voicing, Word Processors, Workbench, Workbench Extras, Workbench Masterclass **AND MUCH MORE BESIDES!**

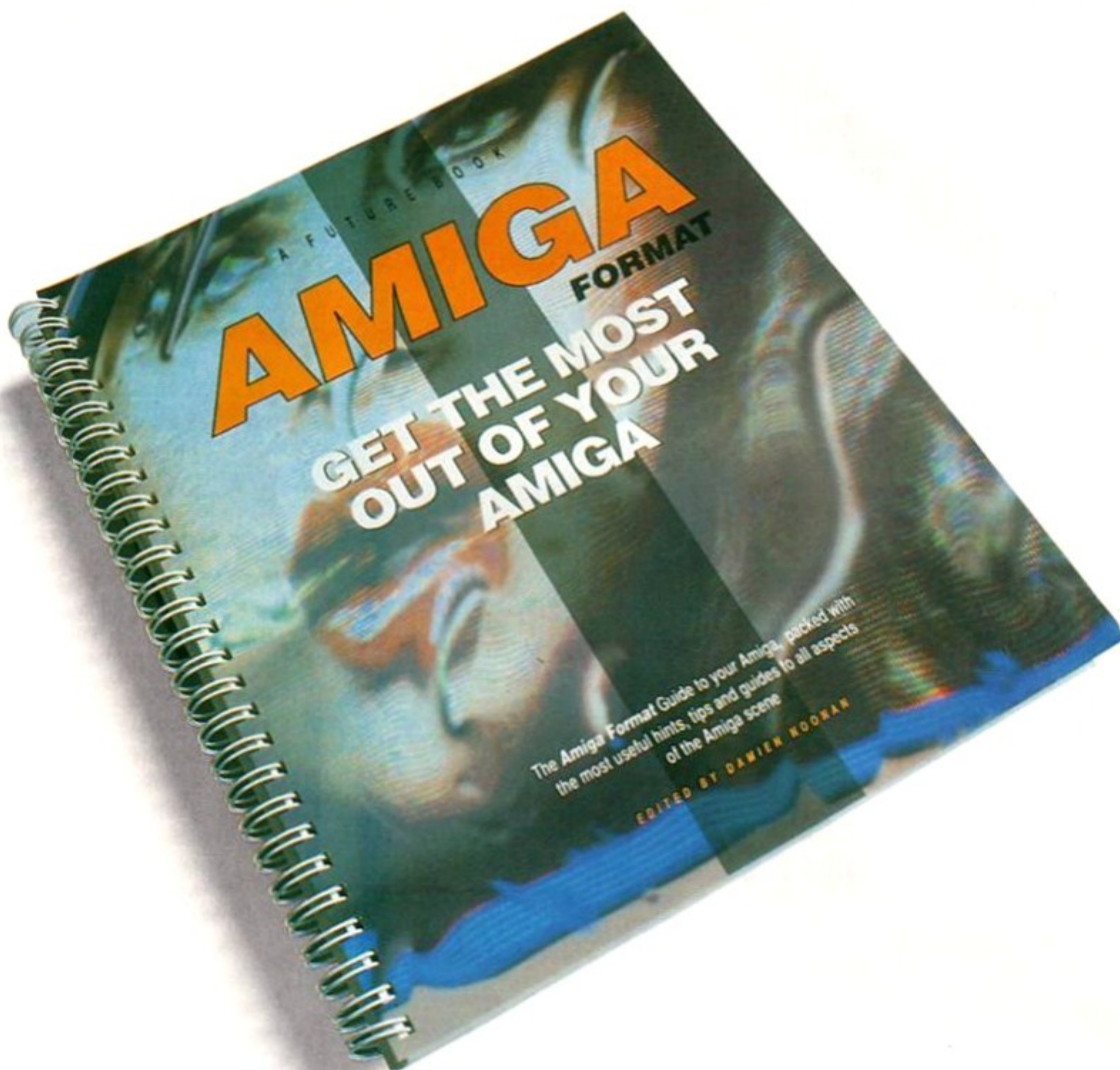

Put together by Editor **DAMIEN NOONAN** and costing £9.95, this book is the ideal guide for the beginner as well as containing stacks of advice for the more advanced user. You can't go wrong!

**Order form**

I would like to order \_\_\_ copy/copies of GET THE MOST OUT OF YOUR AMIGA at the price of £9.95.

(please add £1.45 per copy to cover p&p.)

I would like to order \_\_\_ copy/copies of GET THE MOST OUT OF YOUR AMIGA plus two disks at the price of £13.95.

(please add £1.45 per copy to cover p&p.)

If paying by cheque please send payment with this order form in a sealed envelope to:

**AMIGA FORMAT GTM book offer  
FREEPOST**

**Future Publishing Ltd, The Old Barn,  
Somerton, Somerset TA11 7BR**

No stamp required if posted in the UK  
Please allow 28 days for delivery

Name \_\_\_\_\_

Address \_\_\_\_\_

Post Code \_\_\_\_\_

Telephone \_\_\_\_\_

I enclose a cheque/PO for £ \_\_\_\_\_

Please debit my Access/Visa card:(Delete as appropriate)

My card no is: \_\_\_\_\_

Expiry date: \_\_\_\_\_

Signature \_\_\_\_\_

ALL Prices Include Postage & V.A.T.  
Prices Effective until September 2nd 1991

↑  
Double  
Sided  
Double  
Density

**3 1/2"**

100%  
**ERROR  
FREE  
WITH  
LABELS**

Quantity	Price	Quantity	Price
10	£4.30	80	£27.60
20	£7.80	100	£32.90
25	£9.95	120	£39.40
30	£11.50	150	£48.95
35	£12.95	200	£61.95
40	£14.25	300	£91.90
45	£16.00	400	£119.90
50	£18.25	500	£149.75

Full No Quibble Replacement Guarantee

BOXES (with keys, labels & dividers)

10	40	50	80	100	120
0.94	4.95	5.60	6.30	6.80	8.75

CUMANA CAX354 3 1/2" External Drive £59.95

Armour-Geddon	15.75	Lemmings	15.75
Chuck Rock	15.96	Monkey Island	15.96
Eye Beholder	18.95	PGA Tour Golf	15.96
Gods	15.96	Speedball 2	15.96
Killing Cloud	15.96	Supercars 2	15.96

Credit Card Orders: (9am - 10pm 7 days)

**0 7 1 6 0 8 0 6 2 4**

Cheque/Postal Orders to: Showroom OPEN  
DataGEM Limited 10 am - 6 pm  
Dept AF 23 Pitfield St. Monday - Friday  
LONDON N1 6HB Exit 2 Old St Tube

## SNOOKARD!

The exciting game for parents and kids, of TRIVIA,  
SKILL AND LUCK!

SNOOKARD is THE animated snooker board game  
for all the family.

Available for AMIGA - NOW (Requires 1 meg & mouse)  
Only £10 including post & packing (overseas add £1.50)

EXCLUSIVELY FROM: KEYPHASE SERVICES LTD (AF2)  
26 BLAKE HALL DRIVE  
WICKFORD ESSEX SS11 8XJ

*Psst....Dad, now's your chance to beat the kids on their  
machine - that's got to be worth a tenner!*

## Colour Laser Printing

at 300 x 300 dpi. No horizontal bands  
or pale lines, just pure, solid colour.

IFF/HAM files from DPaint, Photon Paint, DigiPaint etc,  
other file formats please phone.

**£5.00 per file printed on A4.**

(please specify portrait or landscape)

Price includes VAT & U.K. postage.

Please make cheques payable to Studio 101.

**Studio 101 Tel. 0827 280884**

**101 Sudeley, Dosthill, Tamworth B77 1JU**

Visitors by appointment only.

## SEASOFT COMPUTING

The Business Centre, 80 Woodlands  
Avenue, Rustington, West Sussex  
BN16 3EY Tel: 0903 850378



CUMANA  
CAX354  
EXTERNAL  
DISK DRIVE  
**£64.99**  
WITH SWITCH  
AND  
THROUGH-PORT

**SONY**  
3.5" DSDD  
BULK DISKS

10.....£4.99  
50...£22.50  
100..£39.99

Guaranteed 100% error  
free (prices include labels)

1/2 MEG  
UPGRADE  
WITH SWITCH  
ONLY  
**£24.99**  
OR  
**£29.00**  
WITH CLOCK

### 16-BIT POCKET POWER COLLECTION

**£2.99**

PLUTOS - LAS VEGAS  
HOT SHOT - PROTECTOR  
WARZONE - MOUSE TRAP  
QUANTOX - FROST BYTE  
THAI BOXING - FLIGHT PATH 737  
SECONDS OUT - ARTIFICIAL DREAMS  
FIRE BLASTER - FOOTBALL MANAGER  
SPACE STATION - KARTING GRAND PRIX

**£2.99**

### BARGAIN BASEMENT SOFTWARE

(Limited stocks available)

**£4.99**

Blasteroids - Challenger  
Eye of Horus - Flipit Mangose  
Dr Fruit - Ice Hockey  
Prospector - After Burner  
Star Goose - Trained Assassin - Archipelagos - Baal  
Bad Company - Ballistix - Deflector - Dark Fusion  
Hate - Dugger - GFL Golf - GFL Baseball  
Gravity - I, Ludicrous - Jump Jet - Matrix marauders  
Menace - Quadralien - Raider - Star Ray  
Trivia - GFL Football - Yollanda - Space Harrier 2

**£4.99**

### ACCESSORIES

Mouse Mat .....£2.99  
Amiga Dust Cover.....£3.99  
Monitor Cover.....£4.99  
3.5" Head Cleaning Kit.....£3.99  
3.5" DISK STORAGE BOXES  
10 capacity .....£0.99  
40 capacity .....£4.99  
80 capacity .....£6.25  
100 capacity .....£7.50  
150 capacity Posso .....£18.50

#### ★ SPECIAL VALUE STARTER PACK ★

10 X SONY BLANK DISKS  
10 CAPACITY STORAGE BOX  
3.5" HEAD CLEANING KIT  
A500 DUST COVER  
MOUSE MAT  
P.D. LIBRARY DISK  
NORMAL PRICE £17.70

★ OFFER PRICE - ONLY £13.99 ★

## AMOS LICENSEWARE - £3.50

Authorised distributors of Amos Licenceware. These titles are NOT P.D. and  
must not be re-copied. A portion of the price is passed on to the author.

LPD1 Colouring Book	LPD6 Pukado	LPD26 CYAP*
LPD5 Jungle Bungle*	LPD9 Amos Assembler	LPD4 Thingamajig*
LPD8 Work and Play*	LPD12 Hypnotic Land*	LPD7 4 Way Lynx*
LPD11 Go-getter*	LPD15 ArcAngles Shapes*	LPD10 The Word Factory*
LPD14 Play it Safe*	LPD18 Touchstones*	LDP13 Jigmania*
LPD17 Dogfight 2*	LPD21 Quingo*	LPD16 Reversi 2*
LPD20 Wordy - WP*	LPD24 The Shining Way of Kung Fu (2 disks £5.50)	LPD19 X-it-50*
LPD23 ESP		LPD22 LC10 fonts
LPD25 The Mission		
LPD2 Arc Angles Maths		

\* = 1 Meg required.

### QUALITY PUBLIC DOMAIN - £1.00 PER DISK

Library Disk 75p with full details of our collection including  
Postage and packing

(Send stamped addressed envelope for list of titles).

ALSO Seasoft P.D. Packs for greater value, 6 disks per pack  
see list for full details.

### 24 HOUR CREDIT CARD HOTLINE (0903) 850378

**MANNED 6pm to 11pm**

(Answering service at other times)



These items are available by mail order only - No callers please.  
Prices include postage & packing (U.K. mainland) on orders of £10.00 or more.  
Please add £1.00 for orders under £10.00.  
Goods will normally be despatched within 24 hours (subject to availability). Orders under 1Kg are  
sent by first class post. Faulty software will only be exchanged with the same title.  
All prices subject to change without notice. Full terms & conditions of sale available upon request.

## LOYAL CUSTOMER

I am sure that if Nick Cole of Loughborough (August Issue) was to take an 11-mile trip to Leicester, and visit Dimension Computers in the High Street, he would get all the help he needs from Neale – their Amiga salesman. I have dealt with this firm over a number of years and find them only too willing to demonstrate things before I buy them. It's an idea to telephone them first and arrange a time and date, because they're busy people.

JE ROBERTS, LEICESTER

Always a good idea to phone first before visiting a computer shop – if they know when a customer is coming, they can make arrangements.

## CUSTOM ICONS

**£50** Until reading the letter from SS Basel in your August issue, I hadn't used the *IconMerge* program. In a fit of pure recklessness I thought, "What would happen to the solar system if the sun disappeared with the blink of an eye?". So I set about making some split icons for use with my Workbench disk.

After successfully creating a new split System icon, I started on the Trashcan icon. This single icon worked fine until I tried to split it into two different icons. I got error message 212, although my disk did have the Trashcan.info file and the Trashcan directory containing the .info file.

After much messing about and hair pulling, I finally managed to sort it out this way. All clicks are with the left-hand mouse button:

- 1) Start the Workbench disk running as usual (a working copy of course).
- 2) When the disk stops and the Workbench and RAM icons have appeared, remove the disk and put in the Extras disk.
- 3) Then double click on the RAM disk icon to open up its window.
- 4) Double click on the Extras disk icon and double click on the Tools drawer icon.
- 5) Click once on the IconEd icon, hold the button down, and drag the icon onto the RAM disk window. This copies the program into the RAM disk. Do this again with the *IconMerge* program.
- 6) Close the Extras window and the Tools window (click on the small box at the top-left corner of each window). This saves some memory.
- 7) Take out the Extras disk, and put in the Workbench disk again.
- 8) Then double click on the IconMerge icon in the RAM disk.
- 9) When the computer asks if you want to merge or split, simply type s.
- 10) At "Icon 1:", type df0:Trashcan.
- 11) At "Icon 2:", type Trashcan1.
- 12) At "Icon 3:", type Trashcan2.
- 13) Now close the Workbench window, then double click on it again to open it. You should have icons for Trashcan1, Trashcan2, IconEd and IconMerge. You may have to click and drag, to rearrange them and see them all.
- 14) Double click on the IconEd icon.
- 15) Select "Load Data", and type Trashcan1.
- 16) Highlight another editing box (click on it) select "Load Data" and type Trashcan2.
- 17) Edit them to your heart's content.
- 18) When you have finished, save both icons under

# Workbench

Time for the monthly questions-and-answers session, hosted as usual by **Pat McDonald**, our part-time circus clown and Amiga guru.

their original names (Trashcan1 and Trashcan2).

19) After you have saved the icons, close IconEd to get back to Workbench.

20) Close the RAM disk window, and reopen it again. You may have to rearrange the icons, but you should see your new ones there.

21) Double click on the IconMerge icon in the RAM disk window.

22) This time, when the computer asks if you want to merge or split, type m.

23) At "Icon1:", type Trashcan1.

24) At "Icon2:", type Trashcan2.

25) At "Icon3:", type df0:Trashcan. Make sure that that Workbench disk is write-enabled, that is you can't see through the hole in the corner of the disk.

26) Double click on the Workbench disk icon. You should now be able to see your new Trashcan Icon!

27) Double click on the Trashcan icon to see if it works – which it should, if you've followed these instructions correctly.

I hope that this tutorial on splitting, editing and merging icons is of some use to your other readers. It has taken me ages to go through and work it all out, but the actual operation doesn't actually take more than about five minutes to do, (except for the actual icon editing).

HYWEL JENKINS, NEWPORT

Thanks for your excellent step-by-step guide Hywel – have a £50 mail-order voucher, please!

## BAD DISKS

Most of the PD disks and Coverdisks that I possess now won't load! I keep getting the message, "Volume has a read/write error". Can you please explain to me what this means? Also, what is the Diskdoctor? Where can I get one? Sometimes I get the message, "Disk is corrupt, use Diskdoctor to correct it".

G MCKEE, SOMEWHERE

Getting that message means, quite simply, that your Amiga can no longer read the disk. For it to appear occasionally (and I mean occasionally) is no worrying thing, but it sounds like you've either got a badly knackered disk drive or a serious case of virus infection. I suspect that it's the latter.

A computer virus has two functions. Firstly, to copy itself to different disks automatically, and secondly, to activate itself after some time and perhaps wipe disks clean, display a message or even move a large amount of money into a Swiss bank account! Usually, they screw up disks.

Here's what you do. Give Amiganuts (0703 785680) a ring and ask them how much a copy of *Master Virus Killer* version 2.2. This is the best virus killer around for going through a disk collection and wiping out the computer viruses. It recognises 153 different types of virus.

Unfortunately your disk collection is probably now useless. Removing a virus with a virus killer is one thing, but it has already struck. Some viruses merely

## PRINTING MATHS

I am a science student and I often have to write out reports. Next year I will have to type up a rather long project and I want to use my Amiga. Could you please recommend a word processor, or a similar program, which allows the import of graphics and more importantly allows me to use special scientific characters. Ideally, I would like to design them myself.

I was very impressed with the *Wordworth* demo on your Coverdisk, and all-round it seems exactly what I'm looking for, but can it handle the special symbols?

JOHN NUNEZ, LONDON

Creating special characters (or fonts, as they are more commonly known) is pretty easy to do. You can use the Fed

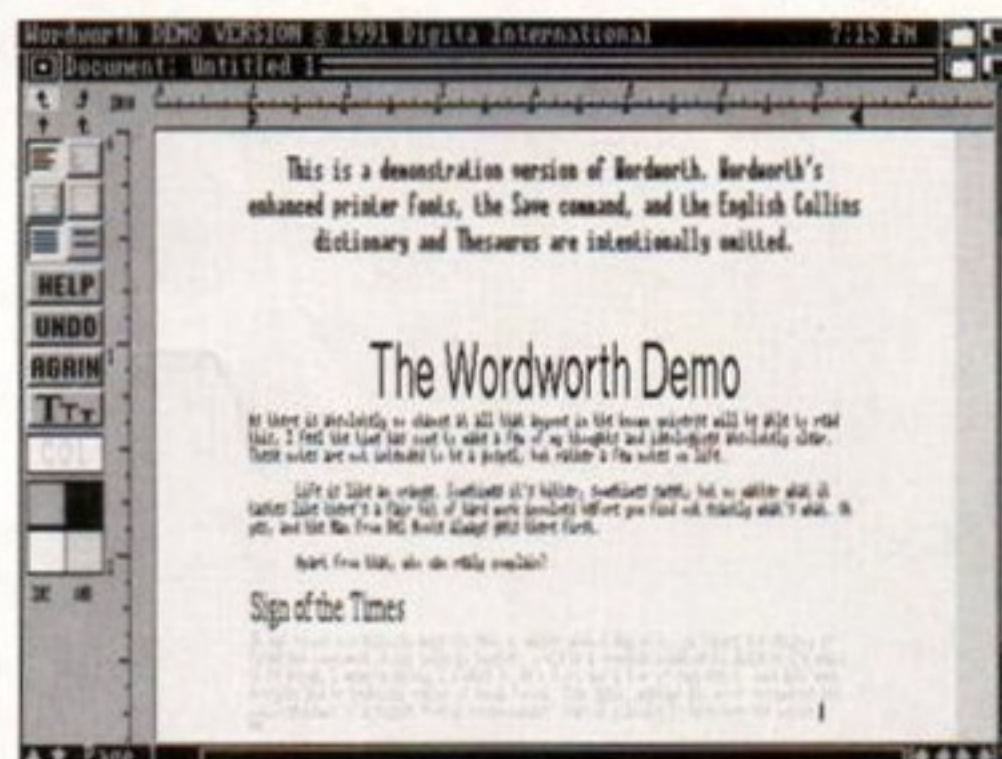

*Wordworth*, which was on AF24's Coverdisk, has a special facility for choosing characters from a loaded font – ideal for specialist characters.

program that is on your Extras disk, plus there are many PD font editors too, which can be used to create scientific symbols, or just about any other kind of character.

The pitfalls occur when you try to print them out. Unless the printer program knows how to translate what you see on the screen in to what your printer can reproduce on paper, then you might indeed have a few problems – some printers are stuck with their own built-in fonts, and so they cannot handle the Amiga graphics fonts (which look like characters but are actually printed as graphics).

Happily, all but the very cheapest printers can print graphics, and so I advise you to go to it if your printer is a nine-pin dot-matrix type or better. As for *Wordworth*, I think you will find it's one of the best programs for laying out designs, and using fonts with odd characters.

prevent a game from working. Your case is probably different – your disks just got destroyed. See the Answerfile advice on getting replacements for games. As for your Coverdisks, you should have backed them up which I advise everyone to do each month.

To safeguard against acquiring any future viruses use MVK 2.2 on every new disk that comes into your possession. Also write protect your disks (move the tab in the corner so that you can see through the hole) no virus can get past this.

Using Diskdoctor: switch on your machine, start up a copy of your Workbench disk, double click on the Workbench icon with the left button, again on the Shell icon, and type:

DISKDOCTOR DF0:

The computer will then prompt you to insert the disk to be corrected in DF0: (the internal disk drive) and to press the Return key once it is in the drive. For the program to work though, the write-protect tab must be off (this means that you cannot see through the hole in the corner of the disk). It reads all of the information off it that it can, and then puts it back on again. Don't bother using it with games disks that produce the "Not a DOS disk" message – it almost certainly will not work. Similarly, do not try to use it on original disks – only use it on copies.

If Diskdoctor is unable to repair a disk then it will mask out the bad bits of a disk, and rename it Lazarus. It is fairly pointless really, but then again Diskdoctor rarely manages to fix a disk.



MVK 2.2 is now very hard-drive friendly, and it can find and kill 153 viruses and has had the bugs taken out – well done, Xavier LeClerq (the author).

### NO FASTMEM

Chaos Strikes Back doesn't work on my A1500. The company (Mirrorsoft) say that it was written before the release of the machine, but *Dungeon Master* and other games work. What's wrong?

M BENNETT, WEST WICKHAM

I'm guessing, but... the A1500 comes with 1Mb of memory as standard. Unfortunately, this memory is all accessible to the graphics chips – so called chip memory. The A500 is set up to have 0.5 Mb of chip memory, and 0.5Mb of fast memory (only the processor chip, the 68000 "decision maker" can access this).

So I guess *Chaos Strikes Back* (and probably some other 1Mb games) need some fast memory to work properly. I advise you to get a memory expansion of some kind, if you really want to play the game.

A similar problem occurs when you modify an A500 to have 1Mb of chip RAM. If no fast memory is available, then animation is impossible on early releases of *Deluxe Paint III* and lots of other programs become similarly changed.

And the moral of the story is: having plenty of chip memory for graphics and sound is all very nice, but having no fast memory is far too high a price to pay. The problem is that it makes your computer less useful, and A1500s or B2000s suck without having any extra memory.



Chaos Strikes Back – it's a lovely looking game, but not on an A1500.

### NON-COMPATIBLE

I am having difficulty with compatibility between my KCS Bitcon PC Emulator and my oldish Supra Sesi hard drive. It's not the 500XP version – the hard drive is in a separate box. If the hard drive starts up, then the Amiga freezes after displaying a lot of hex digits. If I leave it off (don't assign it) then the board works fine.

I've talked to Bitcon many times, and now I'm writing to you to see if you can help. Maybe anyone with a similar setup could write in (A500, KCS, SupraDrive 500XP).

ROBERT BEATTIE, HARROGATE

The problem with older hard drives is that they are often incompatible with new products. Rather than depending on Bitcon, it might be an idea to call Supra (0101 503 967 9081) to talk about how much an upgrade would be to a better hard drive, or perhaps just some new software. Have your computer handy when

you phone up. The KCS board is sold in North America, so I dare say they'll have some ideas – the 500XP is a far cry from the hard drives of old.

### BETTER COVERDISKS

How do I get the utilities to autoboot from your Coverdisk? I would like to have them on a separate disk so that I wouldn't need to use Workbench. For example I think the Hacktrick.60Hz program is really good, but I don't want to load Workbench every time I use it. The same goes for TextEngine.

Sometimes you include icons to install programs onto other disks. Could you please do this more often? Workbench takes so long to load, and surely it's largely unnecessary.

Please print this letter, because my friend and I have made a bet as to whether or not this letter will be printed, and I stand to lose cash over it.

MICHAEL GODBER, BURNTWOOD

Hmm. Sometimes Workbench is necessary, sometimes it's not. Here's what you do. On the backup that you make of the Coverdisk (and you had better – old Coverdisks are irreplaceable), write the names of the programs on the label.

Now, bootup with the Coverdisk, and keep the Control and D keys held down. The startup-sequence to load the main game demo should stop, and you will be left with a little prompt (1>).

Type in the name of the program, for instance HackTrick.60HZ, and press Return. It should load and run. Some programs will not work, because they need some bits from Workbench (which I can't always put on the disk because they take up space – space on the Coverdisk is rare).

Do not despair, I have taken note of your criticism, and I will try to make the programs less dependent on Workbench. It's always a fine edge between usability and usefulness – it could be simple city to use but there wouldn't be anything worthwhile on it.

Any chance of a cut of your winnings? Only joking.

### TINY TIPS



In case the internal disk drive lets you down and your computer is out of warranty, the following is well worth testing before you send it away to be repaired.

Open up your computer and swap around the two 8502A chips, then put the Odd chip where the Even chip is and vice versa. If the disk drive starts working again, then even you're CIA 8502A chip has died on you, and you know exactly what to replace.

However, do not attempt to tamper with your machine if you're not fully confident.

If you use NewZap to peek at binary files, you will often find that there isn't any useful information. This is because these files are often compressed with *PowerPacker*, and need to be uncompressed with the same program to be comprehensible to the human eye.

PowerPacker 3.0a by Nico Francois



PowerPacker is now a licenseware product, available from Softville PD (0705 366509) for £9.20. It compresses/decompresses programs and data so that they take up less space on a disk.

If your word processor (usually *KindWords*) keeps printing odd letters at the top-left of the screen, then make sure that there are two versions of the printer.device file. This lives in the Devs directory.

The good version is 26,904 bytes long, while the bad (version 35.563) is 26,962 bytes long. Look through your floppy collection – you'll probably find a few copies of each.

ANON.

Thanks very much for the tips. Sorry for not printing your name – either I've lost it or you didn't say what it was in the first place. In either case, please write in again to claim your £50 mail-order voucher. I'll be checking handwriting.



# DATAPLEX COMPUTERS LTD.

129 Bath Road,  
Slough,  
Berkshire,  
SL1 3UW

19 High Street,  
Old Town,  
Swindon,  
Wilts

Tel: 0753 535557 Tel: 0793 488448

**SHOWROOM**  
open:  
Mon - Fri  
9.30 - 5.30  
Saturday  
9.30 - 4.30  
**MAILORDER**  
Consumables  
£1.50  
Hardware  
£8.00  
Prices  
excluding VAT

## AMIGA A500 HARDWARE

- Amiga A500 Screen Gems + 1 Meg Pack .....£309
- Amiga A500 Screen Gems Pack + free disks + 10 extra games pack.....£345
- Amiga A500 1 Meg Class of 90's .....£459
- Amiga A500 1 Meg Class of 90's (First Steps) .....£459

## CARTOON CLASSIC PACK

- Amiga A500 including 1 Meg Ram + FREE 10 blank disks, mouse mat **£309**
- (Software includes Lemmings, The Simpsons v Space Mutant, Captain Planet, Deluxe Paint 3)

## SPECIAL OFFERS

- A1500 Base plus software .....£549.00
- A1500 + Philips CM8833 Mk2 Colour Monitor .....£725.00
- A1500 + Commodore 1084S Colour Monitor .....£735.00

## AMIGA/ATARI DRIVES

- 1 Meg 3 1/2 External (Dataplex) £50.00 1 Meg 3.5" internal .....£49
- 1 Meg 3.5" external (Cumana) .....£60
- 1 Meg 5.25" external .....£90

## ACCESSORIES

- 512K Ram + clock .....£30
- Joystick .....£10
- 10 Blank disks in library box .....£8
- Mouse Mat .....£3
- Amiga/Atari Mouse .....£29
- 1 1/2 Meg Ram + Clock .....£99.00
- A500 Power Supply Unit .....£39.00

## INTRODUCTORY OFFER

Screen Filter for your monitors. Protect those precious eyes **£15** (Woven nylon fibre, flare reduction 90%, cuts ultra-violet reflection by 85%)

## MONITORS

- Philips CM8833 MK II Colour Monitor + FREE Lead .....£189

## PRINTERS

- Star LC10 Mono .....£129
- Star LC200 Colour (9 pin) .....£180
- Star LC24 200 (24 pin) .....£210
- Star LC24 200 Colour .....£245
- Panasonic KXP1124i + lead .....£239
- Panasonic KXP 1123 .....£179
- Panasonic KXP1624 .....£329
- Citizen 120D + .....£120
- Citizen Swift 24 + Colour Upgrade .....£249
- Citizen Swift 9 + Colour Upgrade .....£180
- Epson LX400 .....£126
- Epson LQ400 (24 pin) .....£199
- HP Deskjet 500 + Leads .....£349

## AMIGA HARD DRIVES (PROTAR)

- These hard drives come with a 1 year replacement warranty.
- 20Mb External .....£279.00
  - 30Mb External .....£349.00
  - 50Mb External .....£429.00
  - 60Mb External .....£542.00
  - 80Mb External .....£599.00
  - 100Mb External .....£639.00
  - 160Mb External .....£939.00
- All disks come complete with software

Supra  
Amiga

# MODEMS

Supra Modems are guaranteed for 4 years and are auto-dial, auto-answer and fully Hayes compatible.

- Supra 2400** £120 (2400 baud)
- Supra MNP 2400** £165 (2400 baud error correcting)
- Supra 2400 Plus** £220 (The ultimate 2400 baud modem, 9600 baud throughput)

**NEW!**  
Supra  
**9600 Plus** £495  
(V32 9600 baud)

FREE computer cable with every modem

Supra approved distributor  
Open till 7pm

**081-566 3639**

SUPPLY SOLUTIONS,  
PO BOX 2136, LONDON, W13 8QJ



## COMPUTERWISE BRIGHTON

If you live near Brighton you should visit the shop with knowledgeable and friendly staff. A large range of software, hardware and peripherals, most at discounted prices, and with a comprehensive stock you will find what you are looking for...probably.

We are the only dedicated 16 bit computer shop in the South, unless you know different.

We are open 10.00am to 5.30pm  
Monday to Saturday at

**44 George Street, Kemptown,  
Brighton, East Sussex**

Phone: Brighton (0273) 674626

Authorised dealers for Protar Hard Drives.



# SUPER SUMMER SAVERS FROM BCS

NEW AMIGA PD

ASK FOR FREE CATALOGUE DISK

AMAZING DEALS

LOWEST PRICES

- BULK BUYERS**  
**2 FOR 1 DISK GUARANTEE**
- 50 3.5" DS/DD .....£21.75
  - 100 3.5" DS/DD .....£33.00
  - 150 3.5" DS/DD .....£49.00
  - 200 3.5" DS/DD .....£62.00
  - 400 3.5" DS/DD .....£122.00
  - 500 3.5" DS/DD .....£139.00
- 1000+ Call for latest prices  
Prices include VAT/p&p

- GENUINE SONY BULK**
- 50 3.5" DS/DD .....£22.00
  - 100 3.5" DS/DD .....£40.00
  - 200 3.5" DS/DD .....£78.00
  - 500 3.5" DS/DD .....£162.00
- Prices include VAT/p&p

- 3.5" DS/HD**  
**63p EACH**
- 50 3.5" DS/HD .....£30
  - 100 3.5" DS/HD .....£58
  - 200 3.5" DS/HD .....£114
  - 500 3.5" DS/HD .....£280
- Add £3.65 p&p

- SONY BRANDED**  
**3.5" DS/DD**
- 10 3.5" DS/DD .....£6.50
  - 50 3.5" DS/DD .....£32.00
  - 100 3.5" DS/DD .....£64.00
- Add £3.65 p&p

- DISKS & BOXES**  
**2 FOR 1 DISK GUARANTEE**
- 50 3.5" DS/DD + 80 box .....£24.00
  - 100 3.5" DS/DD + 80 box .....£36.00
  - 150 3.5" DS/DD + 80 box .....£51.00
  - 200 3.5" DS/DD + 2 x 80 boxes .....£65
  - 400 3.5" DS/DD + 4 x 80 boxes .....£138
  - 500 3.5" DS/DD + 5 x 80 boxes .....£155
- Prices include VAT/p&p

FREE LABELS

- 5.25" DS/DD**  
**21p EACH**
- 50 5.25" DS/DD .....£10.25
  - 100 5.25" DS/DD .....£20
  - 500 5.25" DS/DD .....£98
  - 1000 5.25" DS/DD .....£190
- Add £3.65 p&p

- 5.25" DS/HD**  
**39p EACH**
- 50 5.25" DS/HD .....£19
  - 100 5.25" DS/HD .....£35
  - 200 5.25" DS/HD .....£67
  - 500 5.25" DS/HD .....£165
- Add £3.65 p&p

- TDK BRANDED**  
**3.5" DS/HD**
- 10 3.5" DS/HD .....£11.00
  - 20 3.5" DS/HD .....£21.50
  - 50 3.5" DS/HD .....£50.00

- Posso Box 150**  
**stackable**  
**£14.95**

- 5.25" DISK BOXES**
- 50 cap. ....£5.10
  - 100 cap. ....£5.90

**PHILIPS MONITOR**  
**CM8833 MKII**  
**£205**

**PAPER**  
**PAPER!**

- 11 x 9.5 60gsm
- 100 sheets .....£2.50
  - 500 sheets .....£10.00
  - 200 sheets .....£4.50
  - 1000 sheets .....£17.00

**AMIGA REPLACEMENT**  
**MOUSE**  
**£14**

**AMIGA DISK DRIVE**  
**£57.50**

- 3.5" DISK BOXES**
- 3.5" 40 cap. £4.10
  - 3.5" 80 cap. £4.50
  - Posso 150 cap. stackable .....£14.95

**STAR LC-200**  
**COLOUR PRINTER**  
**£205**

## AMIGA SPECIALS

- A500 .....£299
- Cartoon Classic Pack .....£360
- Amiga 1500 .....£650
- Screen Gems 1Mb .....£355
- Class of the 90's .....£460
- First Steps .....£499
- Amiga 1500 + 1084S monitor .....£895
- Tenstar Games Pack .....£30

- Cumana drive .....£60
- 1/2Mb + clock .....£30
- 1/2Mb no clock .....£27
- A590 hard drive .....£290
- A590 hard drive + 2Mb RAM .....£380

## AMIGA ACCESSORIES

- Naksha mouse .....£22.50
- Star LC10 Ribbon .....£3.65
- Colour ribbon .....£6
- 4-play games adaptor .....£5
- Mouse mat .....£2.75

- Printer lead .....£8.00
- 1000 labels .....£8.00
- Port ext. lead .....£5.00
- J/stick ext. lead .....£5.00
- 1000 Tractor labels .....£9.00
- Cleaning Kit .....£2.00

## JOYSTICKS

- Quickshot Turbo III .....£7.50
- Zipstick .....£11.00
- JetFighter .....£12.00

Add £3.65 p&p. Add £4 3 day delivery. Add £10 next day. Cheques will be held for clearance

**Call or send cheques/postal orders to: BCS Ltd, 349  
Ditchling Road, Brighton, East Sussex, BN1 6JJ.  
Telephone: 0273 506269/0831 279084.**

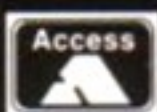

All offers subject to availability. E.&O.E. Trade, Government and Education orders welcome.

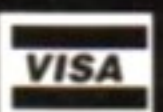

LOTS OF QUESSIES

- 1) I've managed to create a stand-alone version of the Text Engine program (nice one Nick Harvey – hope you don't mind) but I have encountered a few small problems. When it boots, I am left with the Commodore Amiga copyright message and a "1>" prompt to type at. When I type TextEngine and it loads fine – but how do I make the startup-sequence to run the program without typing its name?
- 2) I've included a copy of the Preferences program on the stand alone TextEngine disk, but I still can't access the printer. Help.
- 3) The A690 CD-ROM drive for the A500 – will it play ordinary music CDs, what upgrades will be required for the computer, will it need 1MB of memory and a new processor, plus how much will it cost?
- 4) What are the technical specifications of your average arcade machine compared with an A500? (Processor, memory, speed).
- 5) Can you turn off trap-door 512K memory upgrades without touching the switch, that is use a program?
- 6) Suggest a good-quality and cheap 3.5-inch external disk drive.
- 7) Is there an emulator which costs less than £40 which lets you use IBM PC programs, or Nimbus programs, or Mac programs?
- 8) Do you know how to wire up a CUB 452 BBC monitor to an Amiga?

JOHN SMITH, PORTGLENONE

1) Very easy! Boot up with Workbench, double click on the Shell icon and type:

```
makedir NameofTextEnginedisk:s
ed NameofTextEnginedisk:s/startup-sequence
```

You are now in Ed, the Workbench text editor. Type:

```
TextEngine
```

Press Esc, then X, then return, and it should work OK. NameofTextEnginedisk refers to what the stand alone TextEngine disk is called – avoid using DF0:, DF1: and so on, always use the name of disks before the colon.

2) You need some other files and directories from Workbench. Start Workbench, double click on the Shell, and type in the following:

```
copy all from Sys:devs to NameofTextEnginedisk:devs
copy all from sys:l to NameOfTextEnginedisk:l
copy all from sys:libs to NameOfTextEnginedisk:libs
copy all from sys:c to NameOfTextEnginedisk:c
```

After several thousand disk swaps, you'll be there! Actually, you only need to type the first line for your problem, but Workbench really needs five directories: c, devs, l, libs and s (but you've already got the startup-sequence answer). If you don't want to have to keep doing this, make one disk with those directories on, and copy it when you want to make a stand-alone program. Alternatively, buy an extra disk drive.

3) Yes it will play CDs and no upgrades are required but they are useful (the CDTV has 1MB of chip memory as standard, the A500 does not), it's unlikely to need a new ROM chip inside the Amiga because it will probably be inside the A690, yes it will probably need 1Mb, no you don't need a new processor and it will cost you about £300 or maybe less.

4) It really depends on the arcade machine. Recent arcade games have lots more memory (15 Mb plus stored on ROM chips rather than disk), faster processors (16 MHz) and lots more custom graphics hardware. Of course, a suitably expanded Amiga knocks spots off anything (40 Mb RAM, 24-bit graphics, 68040 processor, read/write magneto-optical hard carts and so on).

5) Yes: lots of custom bootblocks that are in the public domain can do this. Ask a PD library for a disk with such a bootblock, and *VirusExpert* or *Zero Virus III* to copy the bootblock onto your disks.

6) I've never actually seen a duff expensive extra floppy drive. Look out for the Power Computing series (Power Computing 0234 843388) and the Cumana CAX354 (lots of people stock it – check the adverts).

7) No. They cost more than that.

8) If you had sent me the wiring diagram I'd have worked it out for you. Does anyone else know?

ALARMING LACK

I have written a program in Amiga BASIC for an alarm, and whilst wiring up a switch to pins six and eight of the joystick port was easy enough, and they worked OK, it won't, unfortunately, work in the background while *Deluxe Paint III* is running. *Photon Paint* doesn't cause any problems, so do I have to redirect a file or something?

IAN AIRLEY, ANON

When *DeluxePaint III* loads, you may notice two options: 'Load all' or 'Swap'. Normally, you would select Load all, which saves *DPaint* the hassle of having to load different bits from disk as it needs them.

If you select Swap, then it will do this. The problem is that *DPaint* is a very memory-hungry program, so it closes down your program before starting itself. You may find this doesn't work – if so, a bit more memory added to your computer should cure the problem.

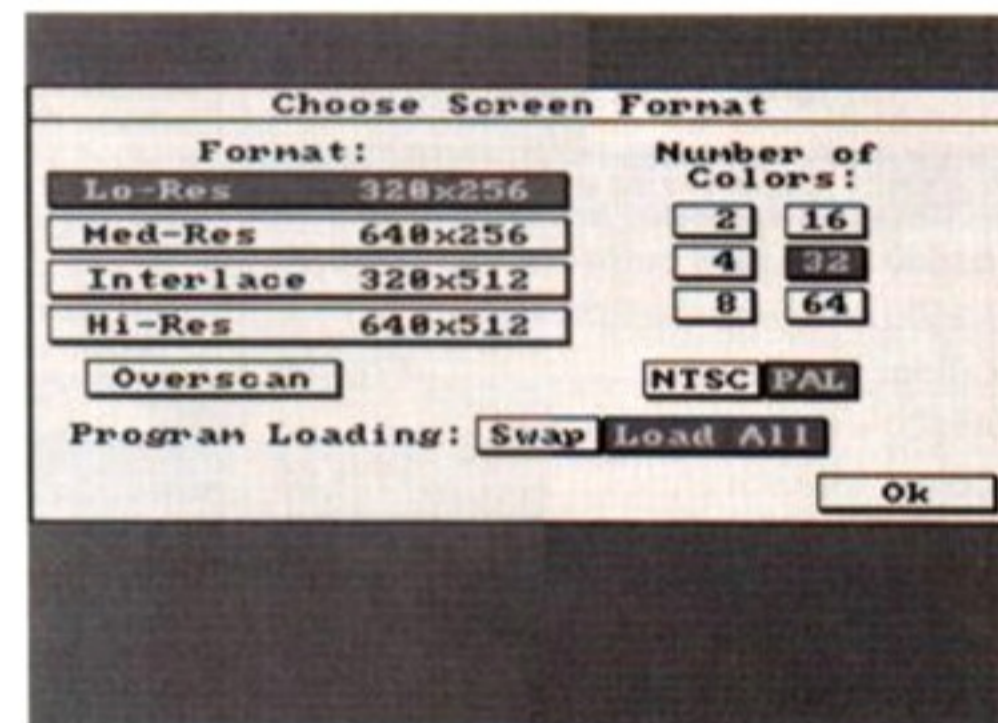

This is a familiar sight to *DeluxePaint III* owners: click on the Swap option to conserve memory.

LOTS MORE MEMORY

I was most interested in your reply to M Hillerby (AF25) regarding the replacement of existing memory chips with larger memory chips, especially when your reply explained that this will work with the A5000 accelerator card.

Could you possibly clarify, though, whether your comment: "you populate all the sockets at once," is in fact correct or can I increase the memory in stages? I realise that I cannot mix the two kinds of chip. (Your *SupraRAM* review says it is added in 2Mb increments). Also, what type of chips do I need?

MIKE LEACH, GOSPORT

Going from memory (it's the weekend, Solid State Leisure are unobtainable and this page is being printed Monday morning) the A5000 does need to have all of the sockets populated at the same time with large capacity RAM chips.

The reason I believe this to be the case is that the memory addressing is fooled by having 16 Mb of RAM available, rather than the maximum four. Normally the board will not take very large RAM chips, unless the whole board is occupied.

It's a bit of gimmick really, but if you really want to splash out on 16 Mb of extra RAM (accelerators boost the Amiga's RAM potential amazingly) then I suggest you telephone Solid State Leisure on 0933 650677 for further information because I'm afraid I honestly don't know.

As for the *SupraDrive*, well you can't mix the type of RAM chips that are on that either – you can use either 256 X 4 chips and expand in 0.5Mb increments, or 1Mb X 4 chips and expand it in 2Mb increments. The sample reviewed was the latter.

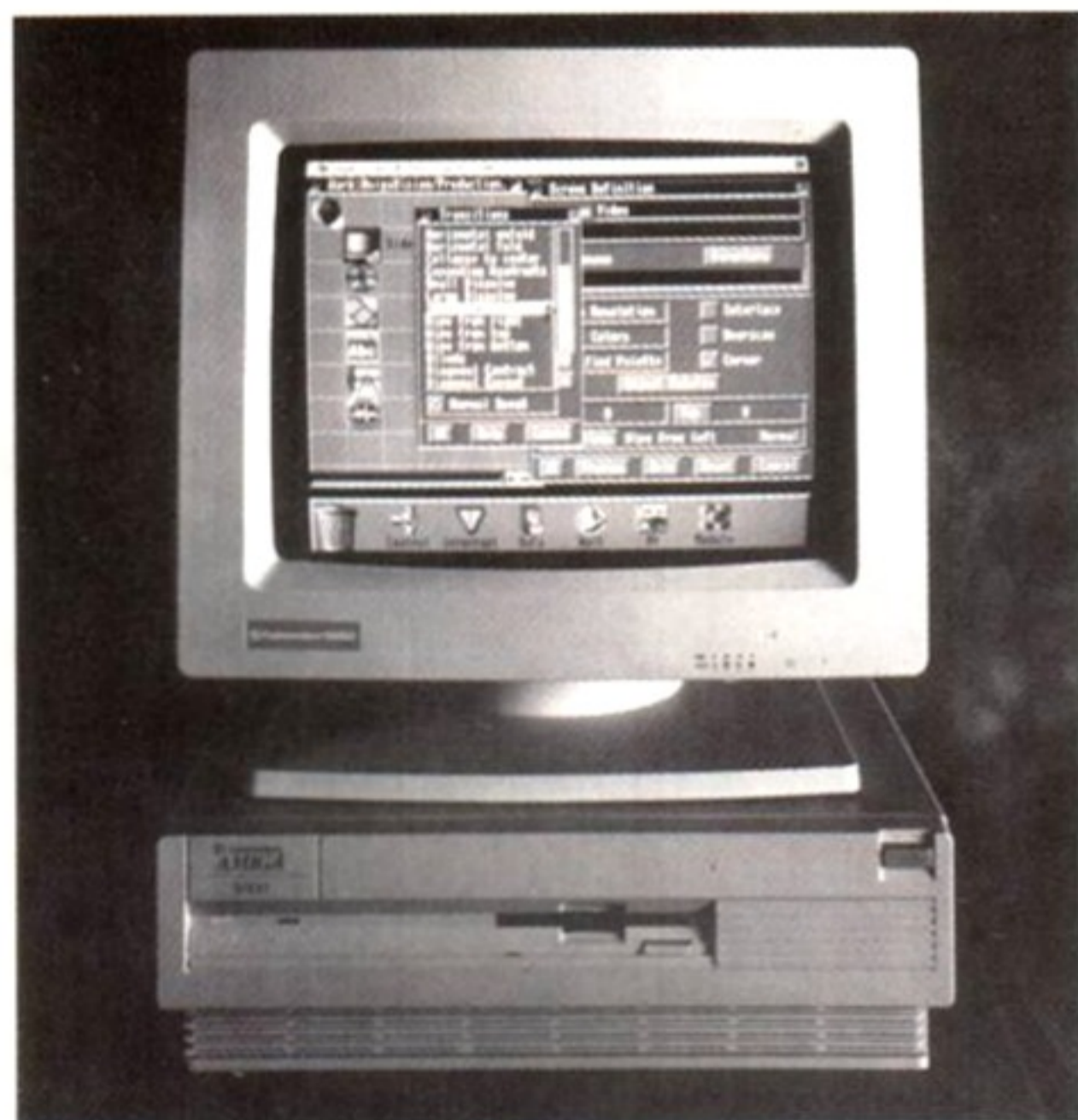

The A3000 is a machine comparable in performance to present-day arcade machines, and at £2,700 plus it's a fraction of the cost to own one.





# AMIGA FORMAT BACK ISSUES

Please use the subscription order form below. Prices per issue include cover disk, packing and postage. UK – £4.00 (issues 18, 23 and 24 £5) Europe – £5.35 Rest of World – £7.65. Sorry issues 1 – 11 are sold out. See panel for issue 18, 23 and 24, which all came with complete games. What an amazing offer!



**13** The glamorous story of how movies become games, plus programming, AMOS in full and ProDraw 2. Bitmaps Brothers' *Cadaver* on the Coverdisk.



**14** Public Domain special issue: what it is, and how to make the most of free software. Plus *Yolanda* demo and a complete PD game on disk.

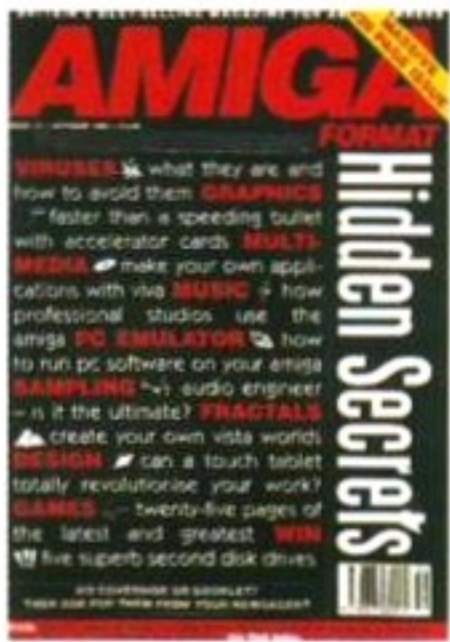

**15** *Flipit and Magnose* makes a brilliant playable demo from Imageworks. How to protect yourself from viruses. Amigas and professional music studios.



**16** Huge feature on the CDTV, the future of home entertainment. Four Format Gold games including *Rick Dangerous 2* – and *Captive* is on the disk.



**17** 24-bit graphics put 16 million colours at your command. Guides to word processors and hard disks plus *Indy 500* and *Killing Game Show*.



**19** If you're buying a new Amiga, new software or new hardware our 'Know your Rights' feature helps you avoid the pitfalls. Adventure ambitions with *Champion of the Raj* in demo.



**20** Get the answers to all your software problems with AF's complete guide to creative and serious software. Puzzle game *The Power* on disk, plus big news DTP and animation reviews.



**21** If you've ever wanted to get into graphics, this issue is the place to start. Details of all the best packages, plus Amiga artists and their tips. Big disk demos *Moonshine Racers* and *Hyperbook*.



**22** Sample it, scan it, grab it: take the world and change it! A spectacular complete guide to taking sounds and images from the outside world. PLUS the Bitmap Brothers' *Gods* on disk.



**25** Discover the secrets and the techniques behind DTP, from making a fanzine to creating a full-colour glossy magazine. Play the amazing *Mega-lo-mania* on a very packed Coverdisk!



## NOT FORGETTING... AMIGA POWER BACK ISSUES WITH COMPLETE GAMES!

- 1** Who do Renegade think they are?; Work In Progress: *Birds Of Prey*; The game I wish I'd written – veteran coders speak; *Rainbow Islands* Players Guide; over 40 new games reviewed, including *Exile*, *Gods*, *Cybercon III*, *Eye Of The Beholder*, *Railroad Tycoon*... **Plus!** On the disk: *Bombuzal* – the complete game!
- 2** *Creation*, 'Bob', *Populous II* – Bullfrog interviewed; 20 Amiga classics for £10.99 or less; Eric Matthews; *Rainbow Islands* continued; over 40 new games reviewed, including *Monkey Island*, *Switchblade II*, *Hero Quest*, *Wonderland*... **Plus!** On the disk: *Kid Gloves* – the complete game!

## Subscribers Club

You not only receive an excellent gift when you subscribe – you can also take advantage of our exclusive subscriber offers! An extra bonus or what? Just take a look! This month's special offer to subscribers is...

### AH-73M THUNDERHAWK Subs Club Price £20.99 Save £10 on the RRP £30.99

Fly a Thunderhawk chopper in the very latest 3D flight sim to hit the Amiga. Programmed by Core Design, this is a game with the emphasis on combat action rather than bogging you down in the tiny dull details. It's easy to play, controlled mainly from the mouse with very few keyboard commands needed to keep you airborne. The excellent 3D graphics will keep you locked into the on-screen action. With its careful blend of realism and playability, this is one for the action fans and the flight sim freaks too!

**SAVE £10**



## Amiga Format issues with complete games!

**18** 300 page Christmas special Games of the year revealed; Top coders make their predictions for games of the future; All the big Xmas games reviewed. Plus! Two disks! *Interphase* – the complete game! *Total Recall* – playable demo! *Lemmings* – playable demo! And more! £5.00



**23** 236 page giant! 3D special: How 3D games are created – The Assembly Line tell all, massive guide to 3D graphics, and more! Plus! Two disks! *Balance Of Power* – the complete game! *Atomino* – playable demo! *3D Construction Kit* – useable demo! And more! £5.00



**24** 220 pages! CDTV special – is this the future of home entertainment?; Graphics special report, and more! Plus! Two disks! *Archipelagos* – the complete game! *Vaxine* – the complete game! And more! £5.00







**WEST YORKSHIRES PREMIERE  
AMIGA AND ATARI COMPUTER STORE**  
AUTHORISED DEALERS FOR STAR CITIZEN COMMODORE ACORN & AMSTRAD

**Come and visit our show-  
room. Most of our products  
are on demo**

**OPENING HOURS :**  
OPEN MON-SAT 9.00AM-5.30PM  
SUNDAY OPENING 11.00AM-3.00PM  
THURSDAY NIGHT LATE TIL 7.30PM

### CLASS OF THE 90'S A500 FIRST STEPS

With 1 Meg of RAM plus over  
£300 worth of software  
**only £469.99**

### ROCTEC 3.5"

1 meg external drive, high quality  
low noise mechanism  
**only £59.99**

### CUMANA 3.5"

1 meg external drive, high quality  
low noise mechanism  
**only £59.99**

### NAKSHA MOUSE

The superior Hi-res mouse with  
mouse mat, holder, and Operation  
Stealth, 2 year guarantee  
**£24.99**

### NEW AMIGA A500 CARTOON CLASSICS

inc Lemmings, The Simpsons,  
Captain Planet, Deluxe Paint 3 and  
One Meg of RAM

**ONLY £379.99**

### AMIGA A500 PACK

Inc Workbench 1.3, Mouse, TV  
Modulator, Leads, Extras disk,  
Manuals and Tutorial

**ONLY £309.99**

### NEW AMIGA A500 MEGA PACK

inc Sim City + Terrain Editor,  
Populous + Promised Lands,  
Their Finest Hour, Battle Chess  
Deluxe Paint 3 and  
One Meg of RAM

**ONLY £384.99**

### CDTV IS HERE!!!

**ONLY £559.99**

**ON DEMO NOW!!!**

WE ARE A COMMODORE  
AUTHORISED DEALER  
OF CDTV

### AMIGA 1500/2000 NOW FROM ONLY £589.99!!

**AMIGA 1500** With DPaint III, Platinum  
Works, Battle Chess, Their Finest Hour,  
Sim City + Terrain Editor,  
Populous + Promised Lands Plus  
The Amiga Tips Book

**Only £679.99**

**AMIGA 1500** With  
Commodore 1084SD moitor, but no  
entertainment or utility software

**Only £839.99**

All our Amiga 1500 packs come complete with two 3.5" floppys, Workbench  
1.3, Mouse, Manuals and Separate Keyboard.

**Full Amiga 1500 package**  
including 1500 base unit, 1084 SD monitor  
and ALL software

**Only £919.99**  
or £904.99 with Philips 8833  
monitor

**QUANTUM 52 MEG** Hard drive

**Only £359.99** fitted  
**Microbotics 8 UP Board** with 2 meg  
of RAM expandable to 8 meg

**Only £179.99**

### SQUIK MOUSE

Hi-res, hi quality micro -  
switched mouse (290 DPI)  
**only £18.99**

### SUPER SOFTWARE BUNDLE

Their Finest Hour, Sim City + Terrain Editor  
Populous + Promised Lands  
and Battle Chess

**only £39.99 !**

### DELUXE PAINT III

The incredible paint and animation  
package

**Now only £39.99**

### FLEXIDUMP

**Printer Driver Utility**  
for really stunning results in colour printer  
dumps.

**only £35.99**

### STAR PRINTERS NEW LOW PRICES!

inc free Std Centronics lead  
**LC10 Mono 9 pin 144/36 cps.....£139.99**  
**LC24-10 24 pin Mono 180/60cps.....£199.99**  
**XB24-10 24 pin Colour 240/80cps,**  
1 year on-site maintenance.....**Only £349.99**  
**LC24-200 Mono 24 pin 222/67 cps.....£249.99**  
**LC24-200 colour 24 pin 222/67 cps.....£309.99**  
**LC200 Colour 9 pin 222/45cps.....£214.99**

### EPSON EPL7100 LASER PRINTER

Now with 1 Meg of memory as standard, expandable to 6 Meg.  
300 \* 300 resolution, 6 pages per minute,  
small footprint, 1 year on site warranty and free lead.

**NEW LOW PRICE only £869.99**

### CANON BJ10e BUBBLE JET PRINTER

Near Laser quality output at a fraction of the price.  
Low noise, portable, and fast (83 cpi letter quality), inc free lead.

**NEW LOW PRICE only £259.99**

### CITIZEN PRINTERS inc Free Lead

**124D Mono (24 pin) 144/40 cps.....£199.99**  
**Swift 9 Mono (9 pin) 192/40 cps.....£184.99**  
**Swift 24 Mono (24 pin) 192/64 cps.....£279.99**  
**Swift 24X (24 pin 136 col).....£389.99**  
**Swift 9/24, 124D auto sheet feeder.....£85.00**

**SPECIAL OFFER: colour upgrade FREE while stocks  
last (RRP £34.99) when you buy any Swift printer**  
2 Year guarantee on all Citizens

### AMIGA PERIPHERALS

#### ICD FLICKER FREE VIDEO

get rid of that irritating flicker from your monitor  
**only £249.99**

#### AMIGA A590 20 Meg For A500 Inc

2 Meg of Unpopulated RAM.....**£289.99**  
inc 2 MEG of ram **only £345.99**

**Vortex 40 Meg for A500..... £299.99**

#### GVP hard disk controller card

card for the Amiga 1500/2000  
**only £149.99**

**MICROBOTICS** hard disk controller  
card for 1500/2000 **only £119.99**

#### QUANTUM hard drives

52 Meg.....**£239.99**

105 Meg.....**£369.99**

Please add the price of a controller card for the full system.

#### THE COMPLETE COLOUR

**SOLUTION BY ROMBO**  
incredible value with RGB Splitter, Vidi  
Amiga and Vidi Chrome.

**only £149.99**

#### RENDALE 8802 GENLOCK the

original high quality genlock

**only £179.99**

Mode switch box for 8802 or HBM **£34.99**

#### HBM GENLOCK similar in spec to

the Rendale 8802 but with  
free Home Titrer software

**only £159.99**

#### NEW NAKSHA

**HAND SCANNER**

Hi-res (400 DPI) inc Daatascan software

**only £149.99**

### NEW LOW PRICES ON 3.5"QUALITY BULK AND BRANDED DISKS

All our disks are **GUARANTEED FOR A  
LIFETIME** and are **CERTIFIED 100%  
ERROR FREE**. Both Verbatim and KAO  
double sided, double density disks are  
recognised as being of the highest quality  
in magnetic media.

#### VERBATIM BULK KAO BRANDED

10.....	£4.99	£6.99
25.....	£10.99	£13.99
50.....	£19.99	£25.99
100.....	£36.99	£44.99
200.....	£69.99	£84.99
300.....	£99.99	£124.99
400.....	£123.99	£159.99
500.....	£144.99	£189.99
1000.....	£269.99	£329.99

Disk Labels.....500.....now only..£6.99  
Disk Labels.....1000.....now only..£9.99

### RAM CHIPS

**256\*4** ideal for A590 & 1 MEG by 1  
chips suitable for 8 up boards & others.

QTY		<b>1 MEG by 8/9</b>
4+.....	£4.99	SIM boards
8+.....	£4.79	<b>only £39.99</b>
16+.....	£4.49	

### EMULATORS

**KCS Power Board** PC/XT Emulator inc  
Dos 4.01. Will not invalidate your warranty

**only £218.99**

#### AT ONCE PC EMULATOR

Turn your Amiga into an IBM AT compatible with this  
easy to fit emulator

**A500 version.....£174.99**

**A1500 version.....£229.99**

### SUPRA RAM EXPANSION

The ultimate Amiga A500 expansion  
Take your A500 up to 9 Mb Fits  
onto the side expansion port Auto  
configured, no software patching

**8 Mb pop to 2 Mb..£194.99**

**8 Mb pop to 4 Mb..£294.99**

**8 Mb pop to 8 Mb..£489.99**

#### ASHCOM 1.8 MEG RAM

Take your A500 up to 2.3 megs total RAM  
with this easy to fit board

**UNPOPULATED .....£34.99**

**512K POPULATED..... £52.99**

**1 MEG POPULATED..... £89.99**

**1.5 MEG POPULATED..... £106.99**

**FULLY (2 MEGS)..... £124.99**

\* Additional Gary board supplied with  
One meg expansion or above \*

#### 512K RAM EXPANSION

Top quality memory expansion for the A500  
inc battery backed clock and on/off switch that  
can be mounted internally or externally

This RAM expansion will not void your  
Amiga warranty.

**ONLY £29.99**

### MONITORS

**SAMSUNG VGA MONITOR**  
WITH FLICKER FIXER  
**ONLY £499.99**

#### COMMODORE 1084 SDI

640 \* 256 Lines Resolution  
Green Screen Facility, Stereo sound  
**£254.99**

#### PHILIPS CM8833 MK2

640\*200 Lines Resolution  
Stereo sound, Green Screen Facility  
**£234.99**

One year on-site warranty

### DISCOUNT SOFTWARE

Imagine the ultimate 3D animation  
rendering system 2 Meg Rec.  
**only £174.99**

**Platinum Works** powerful integrated  
business pack inc Scribble W/P, Analyse  
Spreadsheet with graphics, Database,  
Telecommunications and sideways  
printing **Only £59.99**

**Wordworth** the latest highly  
acclaimed WYSIWYG wordprocessor  
multiple fonts, powerful thesaurus,  
large spellchecker  
**only £89.99**

**Penpal**, this best selling W/P  
incorporates many features found in  
DTP Also includes a database.  
**Now only £64.99**

**Pro Video Plus**, probably the best  
video titling package available  
**only £149.99**

**Page Setter Version 2**, powerful DTP  
at an affordable price  
**only £49.99**

**New AMOS games Compiler**  
now you can supercharge AMOS  
programs **only £24.99**

**Pagestream Version 2**  
Powerful professional DTP package.  
**£139.99**

Deluxe paint III.....	now only £39.99
AMOS the Games Creator.....	£38.99
Sequencer One.....	£74.99
Music X Version 2.....	£109.99
Digiview Gold Version 4.....	£109.99
Protext Version 5 W/P.....	£109.99
Home Accounts.....	£24.99
GB Route Journey planner.....	£34.99
Superbase Personal 2.....	£39.99
Superplan spreadsheet.....	£34.99
3D Construction Set.....	£41.99
3D Text Animate.....	£19.99
Text Scroller.....	£19.99

### MAIL ORDER ?

Order by telephone quoting your credit  
card number. If paying by cheque please  
make payable to **FIRST CHOICE**

**TEL. 0532 637988**

**FAX. 0532 637689**

Please address all  
correspondance to:

**DEPT AF, UNIT 8, ARMLEY PARK  
COURT, OFF CECIL ST, ARMLEY,  
LEEDS LS12 2AE**

### WHY FIRST CHOICE?

- \* All prices include VAT and fast delivery
- \* All products are genuine UK spec.
- \* Free postage UK mainland
- \* Next day delivery only £3.00 extra !
- \* Goods despatched same day as order unless otherwise stated.

Personal Cheques Will Require  
Clearance Before We Can Despatch  
Your Goods. All Prices Correct At  
Time Of Going To Press. All Items  
Listed In Our Advertisements Are Ex  
Stock Ready To Ship Unless We Advise  
Otherwise. Computers Are Always  
Tested Before Despatch.

**\*\*\* NEW! - LIFE ORGANISER - NEW! \*\*\***

This package will really make a difference to the efficiency of your life. "Life organiser" is beautifully designed, easy to use and yet sophisticated, powerful and intelligent. This program is skilfully structured to take everything you wish to remember and present it in a useful and friendly way. Calendars (Any year/month from 1AD to 3000AD!), address book, label/address printer, diary, reminders, birthdays, anniversaries, bills, payments, record of spending, appointments, meetings, notes, memoirs, daily timetable, set up your own system etc. etc. Powerful search facilities will automatically hunt down the information you want. Cassette recorder type controls allow you to step through your information. Powerful MDE facility (Minimum Data Entry) allows you search, cross reference and copy information between entries. Entries only need to be entered once for regular events e.g. weekly, monthly etc. Ideal for business or home use. Once you have used "Life organiser" you will be lost without it! Every package comes with a tutorial booklet and example files. Quality software at **£19.95**

**THE NEW - "BEGINNER'S GUIDE TO AMIGADOS"**

This is a clear and well thought out guide to AmigaDOS. It is a highly effective way to take you from a beginner to an expert on AmigaDOS. It takes you by simple steps, with many examples through the powerful AmigaDOS commands. The emphasis is on learning through experience and doing - not just reading like most other books. In no time at all you will master a fast, powerful and customised operating system...you can easily include your own pictures, messages and programs. This very popular package has now been COMPLETELY updated to cover all AmigaDOS versions. The package consists of a guidebook, a tutorial DISC, a crib card and many other exciting and interesting programs. The guide includes an incredibly fast picture loader, a password system, a gallery of high quality pictures, a variety of boot up sequences, other high quality programs and much, much more...Guide book, Disc, Cribcard etc. only **£13.95**

**WIZARD'S GUIDE TO BASIC**

This guide is a quick, effective and enjoyable way to learn Basic. Your confidence and skills will rise rapidly. In no time at all you will be writing impressive programs. The guide has a sophisticated electronic book - You can get help in the form of text, moving demonstrations, graphics, sound or speech with just a touch of a button. The course starts at beginner level and carefully rises to expert level. You will learn to master graphics, colour, sound, movement, speech, windows, menus, dataprocessing etc. Hundreds of example programs and demos are included on the two discs. This is a value packed package which will leave you with a wealth of knowledge and expertise - **£13.95**

**MASTERPIECE**

The great paintings of the world are displayed on your Amiga using thousands of colours in pictures of outstanding quality. "THE BEST PICTURES I HAVE EVER SEEN ON THE AMIGA" reported a recent review. Two discs packed full of pictures and comprehensive notes take you on an enriching trip into the world of art. Outstanding value - **£8.95**

**\*\*\* NEW DIMENSIONS \*\*\***

Some of the most impressive effects yet seen on an Amiga. You will find that graphics and pictures float before your eyes in front of your screen! The depth of the pictures extends up to ten feet into the screen! These fantastic effects have to be seen to be believed. Included on the disc are generous numbers of 3D pictures, 3D graphics, 3D games and a 3D art program. We even provide a tutorial to help you design your own 3D effects on a paint package or write your own 3D programs. Included in this excellent package are two pairs of 3D specs. Normal price £13.95 **This month only £11.95**

**EXTRA VALUE!**

Buy two or more of the above products and benefit from the following discounts.... 2 products - **£2 discount**, 3 products - **£3 discount**, 4 products - **£4 discount** etc. Discounts are given on the TOTAL value of the order.

UK P&P - FREE and by FIRST CLASS post. Overseas orders welcome - Europeans please add 50p Outside Europe please add £1.50 for airmail. All payments in pounds sterling please.

Cheques / P.O. 's to: **Wizard Software** (Dept. LAF5)  
20, Hadrian Drive, Redhills, Exeter, Devon. EX4 1SR



**HAMMERSOFT**

VISA

**MAIL ORDER SOFTWARE SPECIALIST**

**HARDWARE U.K. ONLY**  
(free delivery, courier £5.00)

**AMIGA PACK 1: (1 Meg of memory)**  
AMIGA A500 SCREEN GEMS:  
TV modulator, Beast II, Days of Thunder,  
Nightbreed, Back to the Future II, Deluxe Paint II, mouse mat & 22 PD games.....384.99

**AMIGA PACK 2: (1Meg of Memory)**  
A500 Cartoon Classics: TV Mod  
Cap'n Planet, Lemmings, Bart Simpson,  
DPaint III, Mouse Mat.....384.99

**AMIGA PACK 3:**  
Basic A500 Plus 10 games.....339.00

**AMIGA PACK 4:** Basic A500.....319.00  
ATARI LYNX GAME CONSOLE.....79.90  
PHILIPS MKII STEREO MONITOR.....249.90  
CBM NEW 1084S MONITOR + LEAD.....264.00  
A590 HARD DRIVE.....274.99  
1/2 MEG EXPANSION/CLOCK.....34.99  
Commodore 1/2Meg Ram/Clock.....59.00  
EXTERNAL 3.5" DISK DRIVE.....69.99  
ATONCE PC Emulator.....199.99  
CITIZEN 120D + PRINTER.....144.99  
CITIZEN SWIFT-9 COLOUR.....235.00  
CITIZEN SWIFT-24 COLOUR.....335.99  
Star LC-200 Colour.....235.00

**SPECIAL OFFERS** (while stocks last)

Amegas (Arkanoid clone).....5.99  
Art of Chess.....5.99  
Back To The Future II.....9.99  
Barbarian (palace).....5.99  
Battle Valley.....8.99  
Burmuda Project, KStart 1.2 only.....7.99  
Data Storm.....5.99  
Days of Thunder.....9.99  
Dungeon Quest.....5.99  
E-Motion.....6.99  
Explosion.....8.99  
Gauntlet II.....8.99  
Grand Monster Slam.....5.99  
Heroes of the Lance 1.2 only.....7.99  
Kid Gloves.....5.99  
Netherworld.....5.99  
Mercenary.....4.99  
Microprose Soccer.....6.99  
Powerplay.....5.99  
RVF Honda.....7.99  
Shufflepuck Cafe.....5.99  
Slayer.....8.99  
Terrorpods.....4.99  
Tower of Babel.....6.99  
Zynaps.....7.99

**LEISURE**

AMOS Game Creator.....36.90  
Altered Beast.....15.50  
Armour-Geddon.....17.99  
A.T.F.II.....15.99  
A.W.E.S.O.M.E + T-Shirt.....22.99  
BATTLE CHESS.....17.99  
Battle Command.....15.99  
CENTURION.....17.99  
Chase HQ II.....15.99  
Chuck Rock.....17.49  
Corporation.....14.50  
Cybercon 3.....17.99  
DAMOCLES.....16.39  
Deuterios.....17.49  
Elite.....17.49  
G.O.D.S.....17.49  
Golden Axe.....17.99  
Interphase.....9.99  
Kick Off II League version.....13.49  
Kick Off (1 meg).....16.49  
Killing Game Show.....17.99  
Lemmings.....17.49  
Lotus Turbo.....16.99  
Mega Lo Mania.....17.99  
PGA Tour Golf.....17.99  
Populous & Sim City.....20.99  
POWERMONGER.....20.99  
Power Up Compilation.....20.99  
Pro Tennis Tour 2.....17.49  
Shadow of the Beast II + T-Shirt.....23.99  
Space Harrier II.....10.99  
SPEEDBALL II.....17.49  
S.W.I.V.....17.49  
Team Suzuki.....17.49  
TEENAGE MUTANT TURTLES.....16.99  
Time Soldier.....8.99  
Toyota Celica Rally.....16.99  
Triad II (Tetris, Menace,Baal).....15.99  
XENOMORPH.....16.99

**ADVENTURE RPG & SIMULATION AMIGA**

BARDS TALE III.....17.99  
BLOODWYCH.....9.49  
Captive.....19.99  
Chaos Strikes Back (1 MB).....17.99  
Crystals of Arborea.....17.99  
Dungeon Master (1 MB).....17.99  
Eye of the Beholder (1MB).....20.99  
F-16 COMBAT PILOT.....17.49  
F-15 Strike Eagle.....25.99  
F-19 Stealth Fighter.....20.99  
Flight of the Intruder.....21.49  
Flight Sim II.....27.99  
Southern U.K./Europe Scenery.....13.99  
The Immortal (1 MB).....15.99  
Red Storm Rising.....14.99  
Secret of Monkey Island.....17.99  
Spirit of Excalibur (1 MB).....20.99

ULTIMA V.....20.49  
U.M.S. II.....19.49  
Wonderland (1Mb).....20.99

**GRAPHICS & VIDEO AMIGA**  
3D Construction Kit.....35.99  
DELUXE PAINT III (PAL) (1 MB).....59.90  
REAL THINGS BIRDS 1+2.....22.90  
Real Things Humans.....22.90  
DELUXE VIDEO III (PAL) (1 MB).....59.90  
Digipaint III (PAL).....59.90  
DIGIVIEW 4 + Digipaint (PAL).....92.99  
PHOTON PAINT (PAL).....13.99  
Professional Draw 2 (1 MB).....99.90  
Pro Video Plus.....179.00  
Pro Video Post.....199.00

**MUSIC APPLICATIONS**

Mastersound Digitizer.....35.90  
MUSIC X U.K VERSION 1.1.....91.99  
Midi Interface + Leads.....29.95  
MIDI Lead.....2.99

**BUSINESS & EDUCATION**

Distant Suns.....39.95  
FUN SCHOOL 2 Under 6's.....14.29  
6-8's or over 8's.....14.29  
FUN SCHOOL 3 (5,5-7 or over 7).....17.29  
GOLD DISK OFFICE.....96.90  
Hisoft Basic.....56.00  
Home Accounts.....20.99  
Kindwords 2.....35.90  
Mavis Beacon Typing Tutor.....20.99  
Micro GCSE:  
MATHS, FRENCH or ENGLISH.....21.99  
PEN PAL (PAL) (1 MB).....68.99  
PROTEXT V4.3 (rec. 1 MB).....66.90  
PROTEXT V5.0 1MB.....103.90  
Pagesetter II (PAL) (1 MB).....46.90  
Pagestream 2.1 (1 MB).....138.99  
Professional Page 2 (1 MB).....147.99  
Superbase Prof.2 (1 or 2 MB).....239.99  
Transwrite.....31.99  
Word Perfect.....164.90  
WORDWORTH.....88.99  
WORKS PLATINUM.....99.50  
Workbench 1.3 Software + Manual.....14.90

**QUALITY JOYSTICKS & ACCESSORIES**

Amiga-Link Serial Cable.....12.99  
Colour Ribbon (LC10).....6.99  
Comp Pro 5000.....13.29  
Comp Pro Extra (clear, auto).....14.29  
Super Prof (autofire, suction).....14.29  
Disk Drive Cleaning Kit.....5.99  
A500 Dust Cover.....4.95  
Mouse Mat.....4.95  
Naksha Mouse.....23.99  
100 Capacity Lockable Disk box.....8.99  
10 x 3.5" DSDD Disks + labels.....6.95

Please Send Cheques/Postal Orders to:

**HAMMERSOFT**, (DEPT F)  
47 MILL ROAD,  
HETHERSETT, NORWICH,  
NORFOLK NR9 3DS

Titles Available on Request!  
ORDERS:  
TEL (0603) 812416

\* = Available on Release  
Prices include VAT & 1ST CLASS  
POSTAGE IN U.K.  
(Europe please add £2.00 per item)  
Return of

Access, Visa, Eurocard & Mastercard Accepted. Cheques Subject to clearance

**KCS POWER**

INCLUDING  
MS-DOS 4.01 - DOS HELP  
Shell - Manuals  
GW-Basic (No Manual)



**PC BOARD**

INCLUDING  
1 Meg On-board Ram Plus  
Half Meg Ram Disk  
Battery-Backed Clock In  
Amiga and PC Mode

<b>SPEED</b>	"Fastest Screen update of any Amiga PC Emulator" "Faster than many 286 AT's"	NCE/March 91 A.Format/Oct 90
<b>COMPATIBILITY</b>	"Excellent. All the s/w I tried ran perfectly."	C. Shopper/Feb 91
<b>STABILITY</b>	"20/20. Faultless operation from day 1"	A. Shopper/June 91
<b>CONVENIENCE</b>	"Unbeaten. for a plain plug 'n' go PC emulator there is no competition."	Computer Shopper/Feb 91

**ALL UPGRADES ARE SOFTWARE BASED**

**NOW SUPPORTING MORE HARD DRIVES - RING FOR DETAILS**

**VISA** ONLY £199.99 Excl Vat. (Postage Incl) (£234.99 Incl)

**Bitcon Devices Ltd, 88 Bewick Road, Gateshead, NE8 1RS. UK.**  
Tel: 091 490 1919. Fax: 091 490 1918  
Trade Enquiries Welcome, UK & Export. See our main Ad next month

**Matrix Software Club**

**SOFTWARE BUYING PHOBIA  
BANISHED FOREVER!**

Our 2; thousand registered members will tell you that our service is unique. Not for them the fear of spending big money on software and risking disappointment because WE'LL BUY BACK ANY THEY DON'T WANT. We've got the classics and the latest, the leisure and the serious for Atari ST, Amiga, and IBM/PC (3 1/2" disk only).

If you suffer from software buying phobia send for our membership information pack enclosing a large s.a.e. and stating your machine to the address below and while you're at it why not get a taste of this month's members competition.

**YOU COULD WIN £100 CASH!**

If you are not yet a member simply telephone the Matrix Cashline on 0836 403807\* and listen. You will need a pen and paper. Calls cost 34p/min cheap and 45p/min other times. (ask the phone owner).

Matrix Leisure Services, Dept AF9, Unit 4 Mill Studio Business Centre,  
Crane Mead, Ware, Herts, SG12 9PY Tel: 0920 444224.

**MATRIX - WORKING FOR MEMBERS**

**STOP PRESS**

**3 1/2" DSDD  
135 TPI DISKS**

**ONLY**

**QUALITY ONLY!**

**31p**

**MADE IN JAPAN**

**HIGH QUALITY TYPE, 100%  
GUARANTEED ERROR FREE**

40 cap disk box .....£3.25    80 cap box.....£3.75  
Mouse mats.....£1.75    Dust Covers.....£3.95

**PLEASE ADD POSTAGE AND PACKING £3.50**

**Tel: 0228 818500**

**ABS DISK SUPPLIES**  
193 Brampton Road,  
Carlisle, Cumbria CA3 9AX



**WIN WIN WIN WIN WIN WIN**

**A £50 MAIL ORDER VOUCHER**

**DIAL 0898 886 200 NOW**

**U. O. D. Ltd CA2 5BB**

**Calls charged at 34p per min cheap/45p peak**

**Q** What is the difference between hardware and software?

**A** Hardware is a term which covers anything physical related to computers. So printers, computers, silicon chips, disk drives and so on are all regarded as hardware. The technical definition of hardware is, "You can kick it".

Software is the term used for programs and data. It really is nothing more than a particular sequence of numbers and it can exist in many different forms. These sequences of numbers can be stored on disk, read into a computer, backed-up to a tape streamer, or printed out. However, the software remains the same – a sequence of numbers. It doesn't matter whether it's a picture, a sound sample or a program – these are regarded as software.

The difference between them is that hardware is unchangeable – it cannot be reprogrammed, changed or tweaked without completely changing it. Software, on the other hand, can be altered and twisted around: software is much more flexible than hardware. That's why one is soft, and the other is hard!

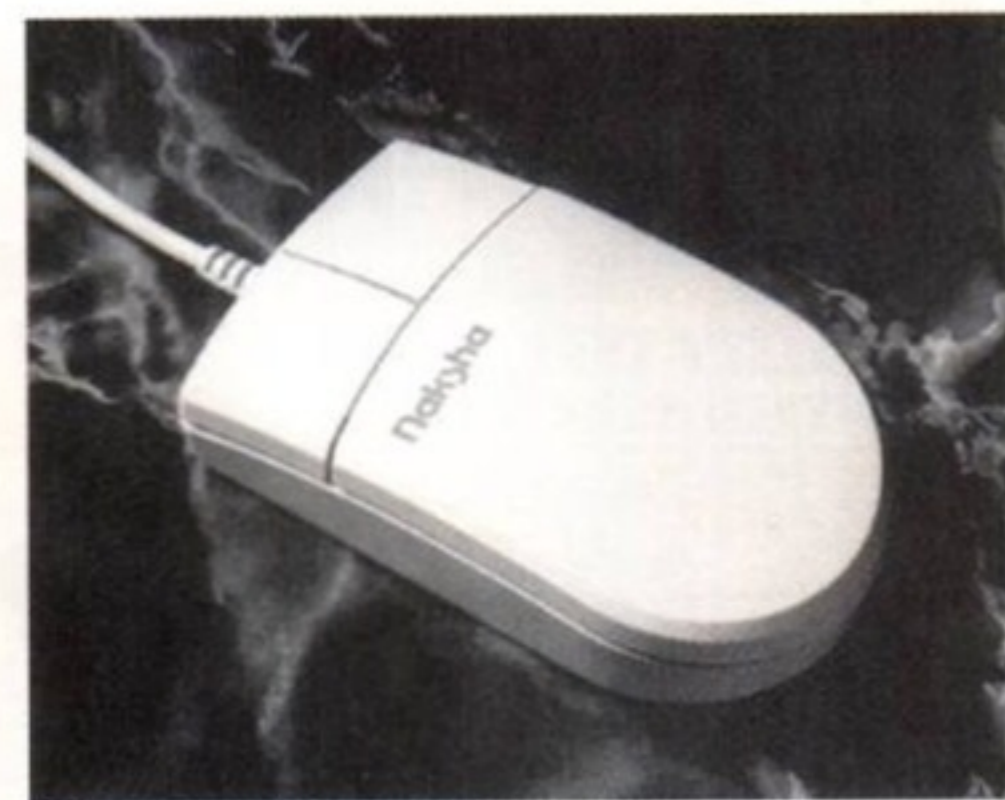

All of the above are hardware – physical equipment that you can touch (or hit in frustration when it malfunctions).

There is one other category, firmware. On some computers (the Amiga included) you can plug-in cartridges which contain programs. These programs are stored on chips called ROMs (Read Only Memory) and cannot be changed without changing the chip.

# Answerfile

Are you in need of some quick answers to common queries?

**Pat McDonald** comes up with the goods in this month's question-and-answer session.

**Q** I'm annoyed as hell because my Amiga has had to be sent back to be repaired. It was still under warranty and it's been away for ages. What should I do?

**A** It's simple: COMPLAIN. Commodore's repair company FMG have never had a particularly good reputation (they had an A500 of ours for over six months!). Commodore appoint their own repair company and so they should have some say in the matter, so I suggest you write to them regarding the problem.

If enough people complain, something might actually get done. It's no good just belly-aching to anybody – talk to the people who are responsible for the long delays. The address to write to is: Steve Franklin, Commodore UK, The Switchback, Gardner Road, Maidenhead, Berks SL6 7XA.

**Q** I've got a lot of program disks that don't work anymore. They are originals, not copies. How do I get them working again?

**A** The best thing to do is to go back to the shop where you bought the product from. Normally they'll be only too happy to replace it with the same program, assuming that they have a replacement in stock. They might have to send it back to the distributor, but you should do this as early as possible.

If it's a game that's a year older or more, then the distributor may not be able to find a copy. The best course of action in this case is to get in touch with the software house. Nearly all of them print their address (and usually the telephone number) in the manuals, usually in extremely small print.

**Q** I bought a second-hand printer dirt cheap without a manual, and I can't get it to work with my Amiga. Help!

**A** Buying anything second-hand is a gamble. You've no guarantee that it works in the first place: if you see it working in one place, it might break on the way home. The manufacturer might have gone out of business, the printer may not even plug into the mains (it could be for use in another country for all you know) and without a manual, you're stuck.

If this happens to you, then you've got to do some detective work. For a start, inspect the printer very closely. Usually, the manufacturer's name and address will be on their somewhere. Write to them and ask for the price of a manual (and it will cost you, not forgetting the postage and delivery charges).

Look at the connector where the Amiga connects to the printer. If it's marked "centronics" or parallel, and is wide and flat with a tongue running across the centre, then it's a parallel printer and you should get a normal Amiga printer cable.

If it's got 25 holes or pins, 13 on the top row and 12 on the bottom, it's probably a serial printer (it might be

marked "RS232"). Get an Amiga serial cable, sometimes called a null modem cable.

**Q** I've heard that my Amiga is a 16-bit computer – what exactly does this mean?

**A** Inside every computer there is one chip that tells all the others what to do. This chip actually takes all the decisions and gives all the orders – it's called the central processor unit, micro processor unit or sometimes just the processor.

In the Amiga, the central processor unit is a Motorola 68,000 chip. And inside it, all information (whether pictures, programs, data, text, animations, blah blah) is stored as binary numbers – little logical on and offs of electricity.

The 68,000 can handle binary numbers of up to 16 digits long without any fancy tricks, so it's called a 16-bit chip. And that's the reason why the Amiga is a 16-bit computer.

However, when you have a different processor (a 68020, 68030, or 68,040) then the picture changes. These chips are 32-bit, that is they can add, divide, multiply and subtract binary numbers of up to 32-bits long. That's why they're so good.

Not just twice as good – every time you add a binary digit, the number doubles, so they can process numbers 65,536 times greater than a standard 68,000 without resorting to exotic programming.

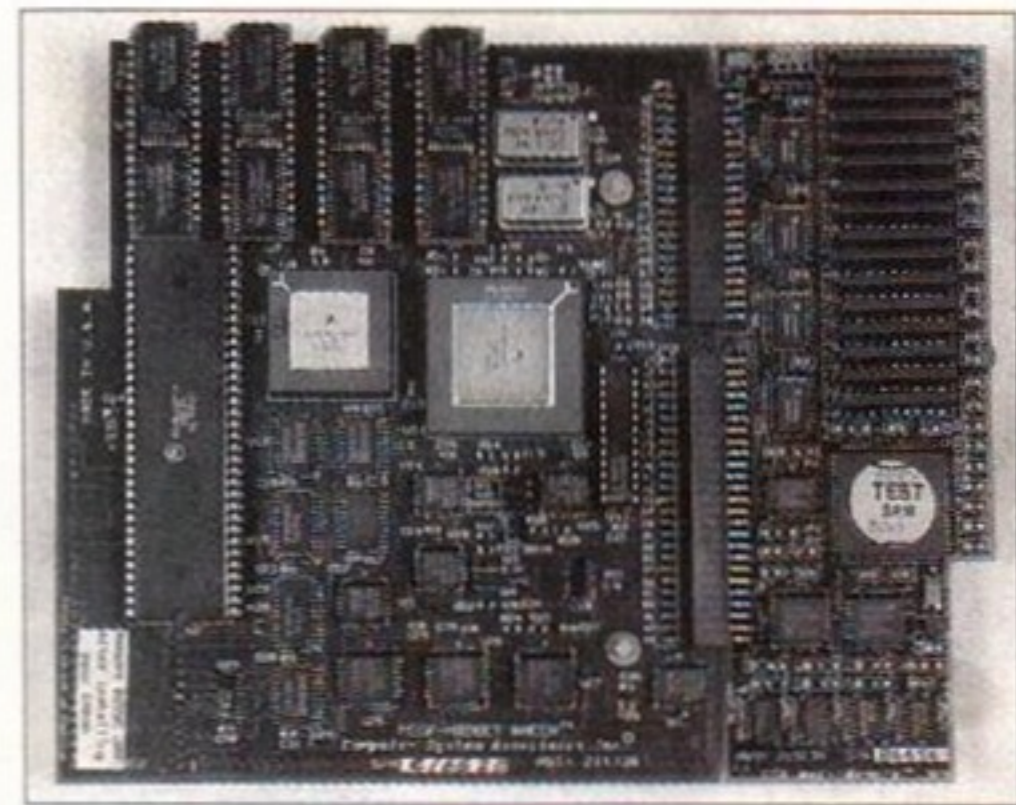

An accelerator board can handle numbers 65,536 times larger than a standard Amiga processor.

**Q** Is it worth buying a head-cleaning kit for my floppy disk drive?

**A** It depends. I would only use a drive cleaning kit about once every two years because they tend to gradually abrade the heads in the disk drive. The real problem with them is after putting the cleaning fluid on the cloth disk, because once you insert the disk into the Amiga the drive stops rotating! By continually rebooting your Amiga, though, with the cleaner in the drive, you should do the job.

**Q** What is an emulator?

**A** An emulator is usually a piece of hard or software which will let you use programs, that is designed for other computers, on your Amiga. Normally you're Amiga can only use Amiga programs.

Emulators exist for the Mac (AMax II - Entertainment International 0268 541126), ST (Medusa and Chameleon - No UK supplier yet) and IBM PC (ATOnce, Vortex/Silica Shop, 081-309 1111). An alternative PC emulator that is extremely good and easy to fit is the KCS board, but it only works on an A500 (Bitcon Devices 091-490 1919).

In addition, there are many software-only emulators available through the PD libraries. Ones for the ST, Commodore 64, ZX Spectrum and even the Sinclair QL can be bought on disk for a few pounds, (although normally you need some extra hardware too) and is available from the program writers.

**Q** I have heard of programs that let you use PC and ST disks with the Amiga (not to run programs, just to swap files). What are they and where can I get them from.

**A** Yes, they do exist. *DOS-2-DOS* and *XDOS* (pronounced "cross dos") are available from various software retailers - check the adverts in this issue. An alternative PD version exists, called

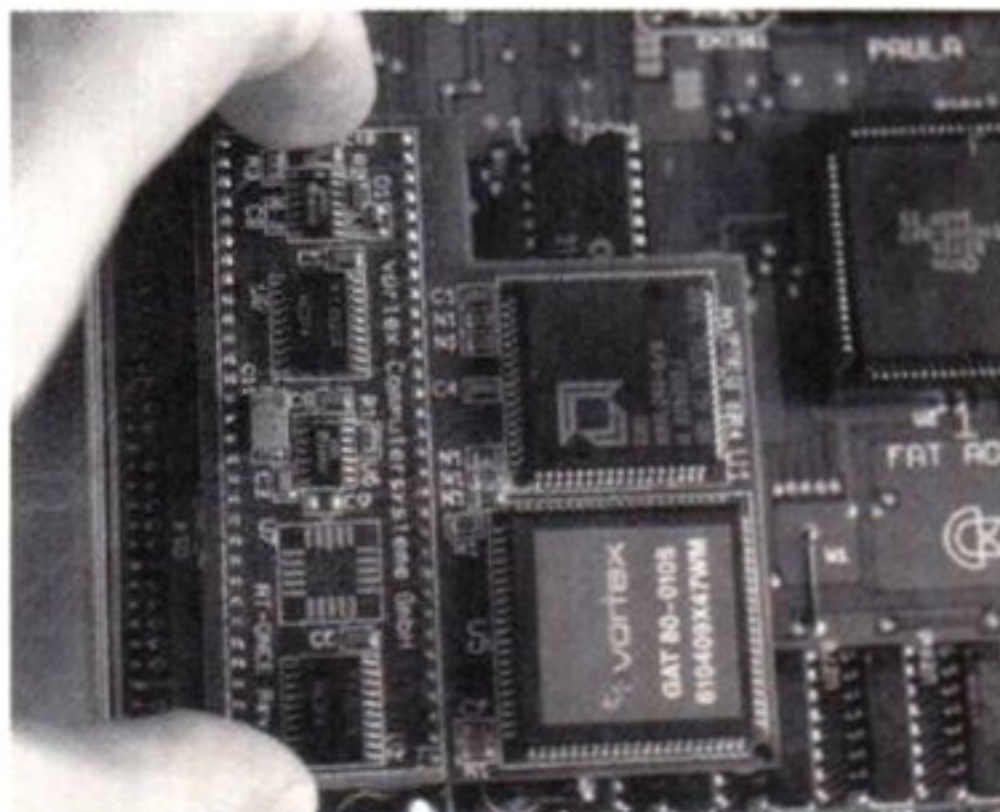

The ATOnce emulator is one of the trickier emulators to fit - it invalidates your warranty. For experienced users only.

*MessyDOS* (although I'm not too sure if this works with ST disks as well).

They work by assigning different names to your disk drives. So if you put a PC disk into your internal disk drive, you would call it "PC0:" rather than "DF0:". Of course, they only work with Workbench-friendly programs, but for virtually all word processors, paint programs, databases and so on they work very well.

Now you know what they're called, I suggest you peruse the adverts in this magazine to find a local supplier, they will be able to help you both with selling you a product and setting it up (they require alterations to your startup-sequence).

**Q** What is a sound sampler - hardware or software? Do you know where can I get hold of one for my A1000?

**A** Strictly speaking, a sound sampler is a piece of hardware. It's a box that plugs into the Amiga (usually through the parallel port), and it's to read in sounds from the real world, and 'digitise' them - turn them into numbers.

To actually do this reading in of sounds, you need a program. Most sound samplers have the software on a disk, which you load up to start sampling sound. However, because sound samplers are all so similar, you can use different sound samplers with different sampling programs.

In short, if you are thinking of buying a sound sampler, then make sure that it comes supplied with some sampling software as well. The best sampling software to get is *AudioMaster III*. Also, if you have an A1000, then make sure that you get a sound sampler that is compatible with your machine, because most of them are not. Datel still do A1000 sound samplers. Datel 0782 744324.

**Q** I have just bought a printer, and I can't seem to find a driver for it with Preferences. I've tried every different driver, what do I do?

**A** First, don't panic. Some printer drivers are so obscure that tracking them down can take months. You can't really blame the computer - there are so many different makes and types of printer.

The good news is you do get some extra printer drivers with your Amiga. They're hidden on the Extras disk - so dig out the back-up that you made of it.

The first thing to do is start the computer up with Workbench, and make another copy of Workbench to alter. Once you have a copy (see the Coverdisk pages for how to copy disks), make some space on it. The



Technosound is probably the best sound sampler to buy for the price - and when you're sick of the software, you can get *AudioMaster III* software and use that instead.

**Q** I have an Action Replay II cartridge and I would like to get a hard drive that works with it (my cartridge is plugged into the hard drive, which is plugged into my A500). Can any hard drive do this?

**A** Sadly, no. No hard drive I've ever tested can do this - even the *SupraDrive 500XP*, which has a connector apparently suitable for the Action Replay. The reason for this is uncertain, but it could be this...

Both the freezer cartridge and the hard drive contain ROM chips, where they store their programs. If you connect two ROMs to the same connector, then they clash. Unfortunately, the A500 only has one connector, on the left-hand side, so you've got a bit of problem.



The Action Replay is not, unfortunately, compatible with the *SupraDriver 500XP* (it does on the other hand work with other expansions though).

easiest way to do this is to drag a few of the less than useful icons to the Trashcan - things like the calculator, the *Say* program.

Don't forget to click on the Trashcan to highlight it. Then select 'Empty Trash' from the Disk menu. Now you should have some space on the disk.

Next, double click on the Shell icon. Printer drivers always live in a directory called Printers, which is always in a directory called Devs, which doesn't have an icon - you can't see it from Workbench. You have to use the Shell.

To do the actual copying, just type in this one line and press Return at the end:-

```
Copy all from Extras1.3:devs/printers
to Workbench1.3:devs/printers
```

This copies all of the printer drivers from Extras onto your Workbench disk. If you specify different disk names, you can copy them onto any disk. For example:

```
Copy all from Extras1.3:devs/printers
to DeluxePaintIV:devs/printers
```

To get rid of the Shell, type this and press Return key:

```
endcli
```

You'll notice I've used disk names, rather than device names (DF0:). It is wise to specify the exact name of a disk followed by a colon, then the directories separated by backslashes. If any names have a space in them, then you must put quotation marks around the lot:

```
Copy all from Extras1.3:devs/printers
to "My disk:devs/printers"
```

You may find that you have not made enough space on the Workbench disk - the computer may come back with a "Volume Workbench1.3 is full," message. In which case make more space on the Workbench disk by disposing other utilities. Then try again.

Once you have all the drivers, test them out by using Preferences to alter the driver. If none of them work, then it's quest time: phone PD libraries, talk to everyone you know, write to the printer manufacturer and either get hold of one or die trying.



# PREMIER MAIL ORDER

Titles marked \* are not yet available and will be sent on day of release.

Please send cheque/PO/Access/Visa No. and expiry date to:

**Dept AF9, Trybridge Ltd., 8 Buckwins Sq., Burnt Mills, Basildon, Essex. SS13 1BJ**

Please state make and model of computer when ordering. P&P inc. UK on orders over £5.00. Less than £5.00 and Europe add £1.00 per item. Elsewhere please add £2.00 per item for Airmail. These offers are available Mail Order only.

Telephone orders: Mon-Fri 9am-7pm. Saturday 10am-4pm. Fax orders: 0268 590076. Tel orders: 0268 590766

147 3D Snooker *	16.99	Gunboat.....	16.99	Prince of Pershia.....	19.99
3D Construction Kit.....	32.99	Gunship.....	14.99	Projectyle.....	8.99
3D Pool.....	7.99	Halls of Montezuma.....	16.99	Quattro Adventure.....	9.99
4D Boxing *	16.99	Hard Drivin.....	6.99	Quattro Sports.....	9.99
4D Driving *	16.99	Hard Drivin 2.....	16.99	R-Type.....	6.99
688 Attack Sub.....	16.99	Harpoon (1 Meg).....	19.99	Railroad Tycoon (1 Meg).....	22.99
African Raiders.....	6.99	Heroquest.....	16.99	Rainbow Islands.....	16.99
Afterburner.....	6.99	Hitchhikers Guide.....	7.99	Rambo 3.....	6.99
Airborne Ranger.....	9.99	Hollywood Collection.....	14.99	R.B.I. 2 Baseball.....	19.99
Amos 3D *	24.99	Horror Zombies.....	16.99	Reach for the Skies *	16.99
Amos Compiler *	19.99	Hunter *	16.99	Realms *	19.99
APB.....	6.99	Hydra.....	16.99	Red Baron *	26.99
Arachnophobia *	16.99	IK+.....	6.99	Rick Dangerous 2.....	16.99
Arkanoid 2.....	6.99	Imperium.....	16.99	Rise of the Dragon *	26.99
Armour Geddon.....	16.99	Indianapolis 500.....	16.99	Robin Simth's Cricket *	16.99
Assault on Alcatraz *	16.99	Indy Jones Adv.....	11.99	Robocop 2.....	16.99
Awesome.....	14.99	Indy Jones - Atlantis Adv *	19.99	Robocop 3.....	19.99
Back to the Future 3.....	16.99	Interceptor.....	8.99	Robozone *	16.99
Bards Tale 2.....	8.99	It Came From Desert (1 Meg).....	14.99	Rocket Ranger.....	7.99
Bards Tale 3.....	16.99	It Came From Desert Data.....	9.99	Rock Star Ate My Hamster.....	4.99
Batman Caped Crusader.....	6.99	Jack Nicklaus Extra Courses.....	9.99	Rotator *	16.99
Batman the Movie.....	7.99	Jack Nicklaus Golf.....	15.99	R-Type 2 *	16.99
Battle Chess 2 *	19.99	Jack Nicklaus Unlimited Golf (1 Meg).....	19.99	Ruff and Ready.....	6.99
Battle Command.....	16.99	James Pond.....	9.99	RVF Honda.....	9.99
Beastbusters *	16.99	Jungle Book.....	6.99	Search for the King *	16.99
Betrayal.....	19.99	Kamikaze.....	6.99	Secret of Monkey Island (1 Meg).....	16.99
Big Game Fishing *	16.99	Keef the Thief.....	8.99	Secrets of Luftwaffe *	19.99
Billy the Kid *	16.99	Keef the Thief Hint Book.....	5.99	Shadow Dancer.....	16.99
Birds of Prey *	26.99	Keys of Maramon *	16.99	Shadow of Beast 2.....	26.99
Blazing Thunder.....	6.99	Kick Off.....	7.99	Shadow Sorceror *	19.99
Blue Max.....	19.99	Kick Off 2 (1 Meg).....	14.99	Shadow Warriors.....	16.99
Brat.....	16.99	Killing Cloud.....	16.99	Shuttle *	19.99
Budokan.....	8.99	Kings Quest 4 (1 Meg).....	26.99	Silent Service.....	9.99
Cadaver.....	16.99	Knights of the Sky *	19.99	Silkworm.....	6.99
Cadaver Data Disk.....	9.99	K.O 2 - Final Whistle.....	8.99	Sim City+Populous.....	19.99
California Games.....	6.99	K.O 2 - Giants of Europe *	7.99	Sim Earth *	19.99
Castles *	19.99	K.O 2 - Return to Europe *	7.99	Simulcra.....	7.99
Captive.....	16.99	K.O 2 - Super League *	9.99	Skull and Crossbones.....	16.99
Carrier Command.....	7.99	K.O 2 - Winning Tactics.....	5.99	Space Ace.....	26.99
Car Vup.....	9.99	Last Ninja 2.....	6.99	Speedball.....	7.99
Centurion.....	16.99	Last Ninja 3 *	16.99	Speedball 2.....	16.99
Chaos Strikes Back (1 Meg).....	16.99	Leather Goddess.....	7.99	Storm Ball.....	12.99
Chuck Rock.....	12.99	Legend *	16.99	Stratego *	16.99
Chuck Yeager.....	16.99	Legend of Billy Boulder *	16.99	Strip Poker 2 + Data.....	6.99
CJ's Elephant Antics.....	6.99	Leisuresuit Larry 3 (1 Meg).....	26.99	Stunt Car Racer.....	15.99
Codename Iceman (1 Meg).....	26.99	Leisuresuit Larry 2.....	26.99	Subbuteo.....	6.99
Colonels Bequest (1 Meg).....	26.99	Lemmings.....	16.99	Super Cars 2.....	16.99
Commando War *	16.99	Licence To Kill.....	6.99	Super Grand Prix.....	6.99
Continental Circus.....	6.99	Lombard Rally.....	6.99	Super Hang On.....	6.99
Conquest Camelot (1 Meg).....	26.99	Lord of the Rings *.....	16.99	Super Monaco GP.....	16.99
Corporation.....	9.99	Lords of Chaos.....	16.99	Supremacy.....	19.99
Corporation Data Disk.....	4.99	M1 Tank Platoon.....	19.99	Switchblade.....	6.99
Creatures *	16.99	Magnetic Scrolls Coll *.....	19.99	Switchblade 2.....	16.99
Cricket (1 Meg).....	17.99	Magnum 4.....	19.99	SWIV.....	16.99
Cricket Captain.....	16.99	Man Utd. Europe.....	16.99	Sword of Sodan.....	9.99
Crime Doesn't Pay *	16.99	Masterblaster *	16.99	Swords of Twilight.....	8.99
Cruise For A Corpse *	16.99	Master Golf *	19.99	Swords of Twilight Hint Book.....	5.99
Cybercon 3.....	16.99	Mega Traveller 1 (1Meg).....	19.99	Team Suzuki.....	16.99
Daley Thompson Challenge.....	6.99	Mega-Lo-Mania *.....	16.99	Team Yankee.....	19.99
Das Boot.....	19.99	Mercs.....	16.99	Teenage Mutant Turtles.....	16.99
Defender of the Crown.....	7.99	Miami Chase.....	6.99	Terminator 2 *.....	16.99
Defenders of the Earth.....	6.99	Midwinter.....	14.99	Test Drive 3 *.....	16.99
Deluxe Paint 3.....	49.99	Midwinter 2 *.....	22.99	The Immortal (1 Meg).....	16.99
Deuterus *	16.99	MIG 29.....	22.99	Their Finest Hour.....	19.99
Disney Animation.....	59.99	Moonshine Racer.....	12.99	Thunderhawk *.....	19.99
Double Dragon.....	6.99	Moon Walker.....	6.99	Tip Off *.....	14.99
Dragon Strike *	19.99	NAM.....	19.99	Toki *.....	16.99
Dragons Breath.....	12.99	Narc.....	16.99	Toobin.....	6.99
Dragons Lair (1 Meg).....	26.99	Navy Seals.....	16.99	Top Cat Bev. Hills.....	6.99
Dragons Lair 2 - Singes Castle.....	26.99	Nightbreed.....	16.99	Torvak The Warrior.....	9.99
Dragons Lair - Time Warp.....	26.99	Nightbreed RPG.....	16.99	Total Recall.....	12.99
Dragons Wars.....	16.99	Nightshift.....	9.99	Toyota Celica.....	16.99
Duck Tales.....	16.99	Obitus.....	14.99	Tracksuit Manager 2 *.....	16.99
Duster *.....	16.99	Off Road Racer.....	16.99	Turbo Challenge.....	16.99
Elf *.....	16.99	Omicron Conspiracy.....	7.99	Turbo Challenge 2 *.....	16.99
Epic *.....	19.99	Operation Stealth.....	16.99	Turrican 2.....	16.99
Escape from Colditz.....	19.99	Operation Thunderbolt.....	16.99	TV Sports Basketball.....	14.99
Excalibur *.....	16.99	Operation Wolf.....	6.99	TV Sports Football.....	7.99
Eye of the Beholder (1 Meg).....	19.99	Oriental Games.....	9.99	Ultima V.....	19.99
F15 Strike Eagle 2.....	22.99	Outrun.....	6.99	UMS 2 (1 Meg).....	19.99
F16 Combat Pilot.....	16.99	Pang.....	16.99	Violator.....	6.99
F19 Stealth Fighter.....	19.99	PGA Tour Golf.....	16.99	Viz.....	16.99
Fantasy World Dizzy.....	6.99	Platinum.....	16.99	Walker *.....	16.99
Ferrari Formula 1.....	8.99	Platoon.....	6.99	Warlords (1 Meg).....	19.99
Final Fight *.....	16.99	Player Manager.....	12.99	War Zone.....	12.99
First Samuari *.....	16.99	Pool of Radiance (1 Meg).....	19.99	Welltris.....	9.99
Flight of the Intruder *.....	22.99	Police Quest 2 (1 Meg).....	26.99	Wheels of Fire.....	12.99
Flood.....	8.99	Populous.....	16.99	Winning Team *.....	19.99
Football Director 2.....	13.99	Populous 2 *.....	19.99	Wings (1 Meg).....	19.99
Football Man World Cup.....	9.99	Populous Promised Lands.....	7.99	Wizball.....	6.99
Ford Q8 Rally *.....	16.99	Powerdrome.....	8.99	Wizkid *.....	16.99
Forgotten Worlds.....	6.99	Powermonger.....	19.99	Wolf Pack (1 Meg).....	19.99
Gauntlet 2.....	6.99	Powermonger Data Disk 1 *.....	9.99	Wonderland (1 Meg).....	19.99
Gauntlet 3 *.....	16.99	Powerpack.....	14.99	World Class Leaderboard.....	6.99
Gazza 2.....	16.99	Power Up.....	19.99	Wrath of the Demon.....	19.99
Gem X.....	16.99	P.P. Hammer.....	16.99	Xenomorph 2 *.....	16.99
Gods.....	16.99	Predator.....	6.99	Yogi's Great Escape.....	6.99
Golden Axe.....	16.99	Predator 2.....	16.99	Yogi & Greed Monster.....	6.99
Gremlins 2.....	9.99	Prehistorik.....	16.99	Z-Out.....	13.99

## SPECIAL OFFERS

**GOLDEN IMAGE  
SCANNER  
ONLY £159.99**

**OPTICAL MOUSE  
ONLY £34.99**

**UPGRADE YOUR  
AMIGA TO 1 MEG**

1/2 Meg Upgrade - **£24.99**

1/2 Meg Upgrade + clock - **£26.99**

**SWORD OF SODAN**

NOW ONLY  
**£9.99**

**STEREO SPEAKERS**

**AMIGA  
ONLY £29.99**

**TECHNOSOUND  
£34.99**

**3.5" EXTERNAL  
DRIVE  
ONLY £52.99**

## JOYSTICKS

Cheetah 125 + - £6.99

Comp Pro Extra - £14.99

Quickjoy 2 Turbo - £9.99

Quickshot 3 Turbo - £9.99

Quickjoy Jetfighter - £10.99

## BLANK DISKS

**Unbranded**

10 x 3.5" DSDD - £5.99

20 x 3.5" DSDD - £10.99

50 x 3.5" DSDD - £23.99

100 x 3.5" DSDD - £44.99

**Branded - TDK**

3.5" DSDD - £1.25 Each

## WINGS 1/2 Meg

Now Only  
**£11.99**



**FREE**  
**5 DISKS OF THE**  
**LATEST PD SOFTWARE**  
 WITH ANY PURCHASE FROM THIS AD  
 (DEMOS UPDATED REGULARLY)

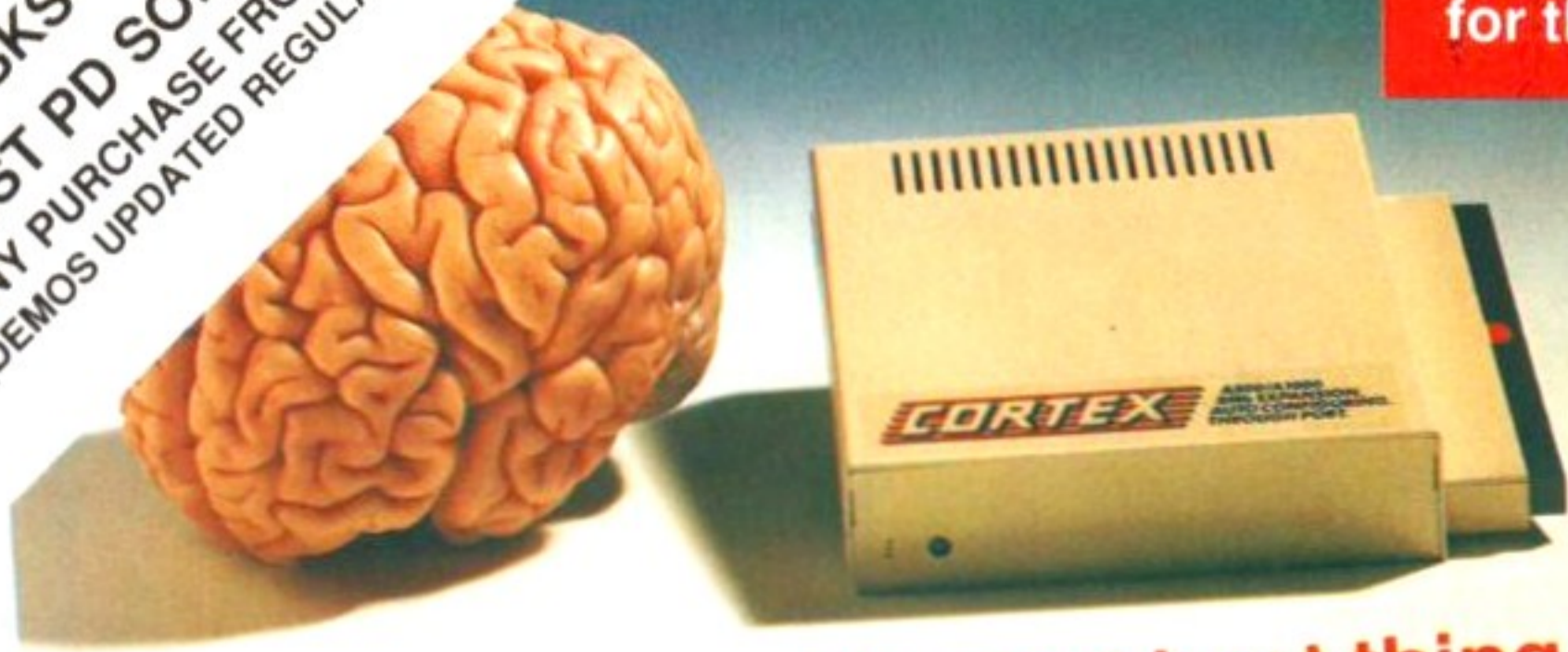

**A Brain . . . . the next best thing**

**CORTEX 8Mb RAM EXPANSION**  
 for the Commodore Amiga A500/A1000

- External fitting. Warranty remains intact
- Fully implemented auto-configure
- Fully operational through-bus
- Uses standard 1M x 8bit or 1M x 9bit SIMMs
- Complete with its own power supply unit (UK, US or EURO)
- Designed with A1000 compatibility in mind
- Zero wait-states
- RAM test software

2Mb- **£269** 4Mb- **£349** 8Mb- **£519**

**CORTEX 512K RAM EXPANSION for the Commodore Amiga A500**

- Essential A500 upgrade - 1Mb Amiga is now standard
- Functional equivalent of CBM A501
- Lower power 1Mbit DRAM
- Latest technology high-quality components
- "Fatter" Agnus compatible for 1Mb CHIP RAM
- Lower profile enable/disable switch
- Available with or without battery-backed clock/calendar module

**£27.95**  
 (£31.95 with clock)

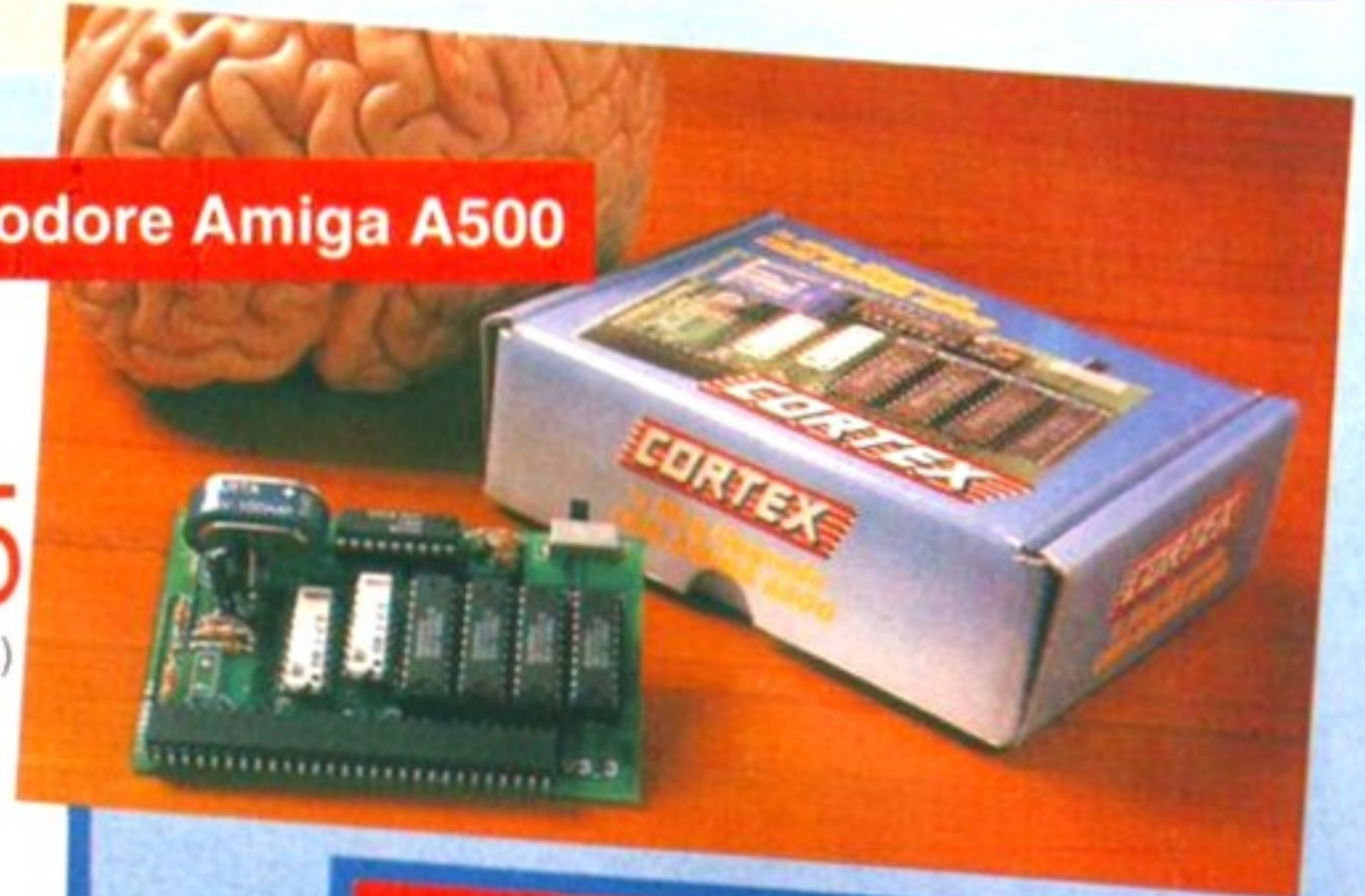

**CORTEX EXTERNAL 3.5" FLOPPY DRIVE**

- High-quality silent mechanism
- Through port
- Enable/disable switch

**£59**



**AMIGA HARD DISK & MEMORY SYSTEMS BY XETEC Inc.**



• See CHIP UPGRADES section for Xetec RAM upgrade prices

- Xetec FastTrak hard disk system for A500 (A1000 version available to order) 8Mb FastRAM card (optional) Super-fast (9ms) auto head-park Quantum 52Mb Pro-Drive **£499**
- Xetec FastCard Plus hard disk system (for A1500/A2000) featuring Seagate 48Mb auto head-park drive space for 8Mb Fast RAM on board (using SIMMs) **£449**

**NEW IN**

**CHIP UPGRADES**

- **1Mb Agnus Chip 8372A** - Upgrade for older Amigas (not A1000) - Enables 1Mb CHIP RAM for enhanced graphics and sound - requires some technical skill to fit - instructions supplied. **£60**

- **ROM Upgrade Version 1.3** - Essential upgrade for hard-disk users - featuring the FastFile System **£35**

- **A3000 RAM Upgrades:** Special static column mode DRAM for the A3000 workstation. IN STOCK NOW **4Mb- £269**

- **1M x 8bit SIMMS** (for Cortex 8Mb cards and Xetec hard disk systems with RAM) **2Mb - £90, 4Mb - £175, 6Mb £260**

- **256K x 4bit DRAM** (for CBM A590, CBM 2091, ICD AdRAM, Ashcom etc). **0.5Mb - £25, 1Mb - £49, 2Mb - £95**

- **1M x 1bit DRAM** (for most A2000 cards) price same as 256K x 4bit

**CORTEX 8Mb RAM EXPANSION for the Commodore Amiga A1500/A2000**

- Fully implemented auto-configure
  - Zero wait-states
  - Uses standard 1M x 8bit or 1M x 9bit SIMMs
  - 2, 4, 6 or 8Mb configurations possible
- 2Mb-**£199** 4Mb-**£289** 6Mb-**£369** 8Mb-**£449**



**FREE**  
**5 DISKS OF THE**  
**LATEST PD**  
**SOFTWARE**  
 WITH ANY PURCHASE FROM THIS AD\*  
 (DEMOS UPDATED REGULARLY)

All prices include VAT and Postage & Packaging. Trade enquiries welcome

Send cheques to:

**CORTEX DESIGN & TECHNOLOGY LTD**

BRITANNIA BUILDINGS, 46 FENWICK STREET, LIVERPOOL L2 7NB

• 24 HOUR SALES 051-236 0480 • 24 HOUR FAX 051-227 2482

★ Free software is limited to one set per order and is supplied without warranty



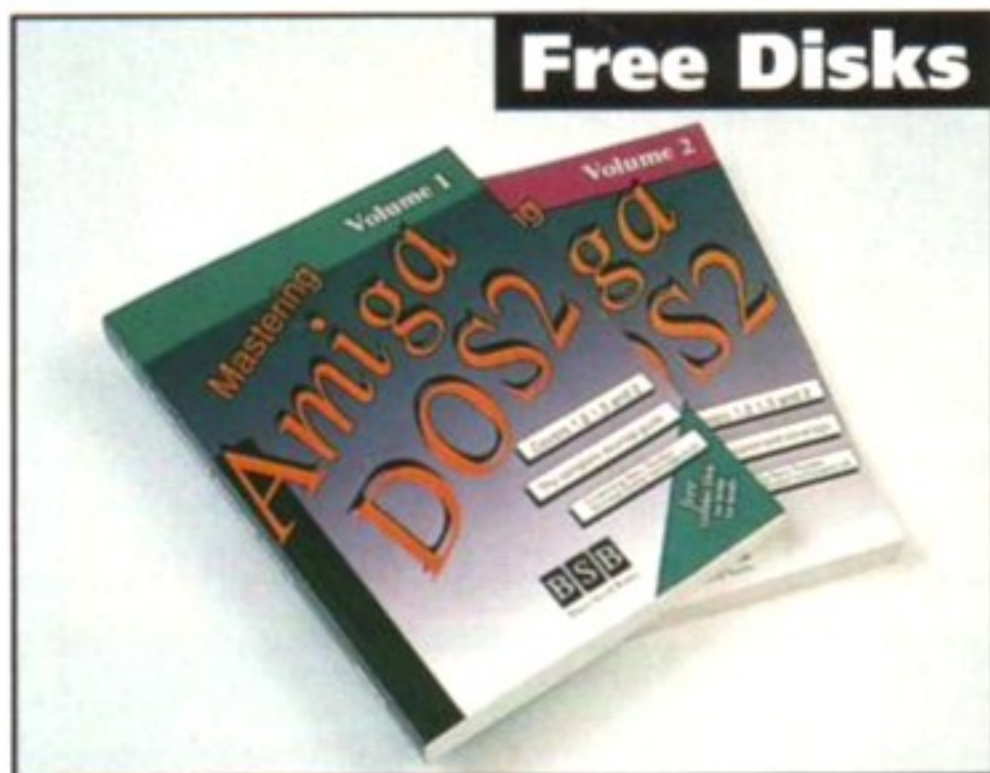

**Free Disks**

### Mastering AmigaDOS

The best way to learn all about the Amiga's operating system and CLI commands. Vol 1 comes with Disks 1 and 2 while with Vol 2 you will receive Disk 2, which is specially compiled for *Amiga Format*.

Description	Price	Order No
<b>Volume 1</b>	<b>£21.95</b>	<b>AM192</b>
<b>Volume 2</b>	<b>£17.95</b>	<b>AM193</b>



**SAVE £5**

### Naksha mouse & Tracey

Improve your mouse control with this high-quality replacement mouse. It comes with Tracey, a special tool (RRP £7.95 but free to you!) which will allow you to trace pictures with the aid of your mouse.

Description	Price	Order No
<b>Naksha mouse and Tracey</b>	<b>£23.95</b>	<b>AM191</b>

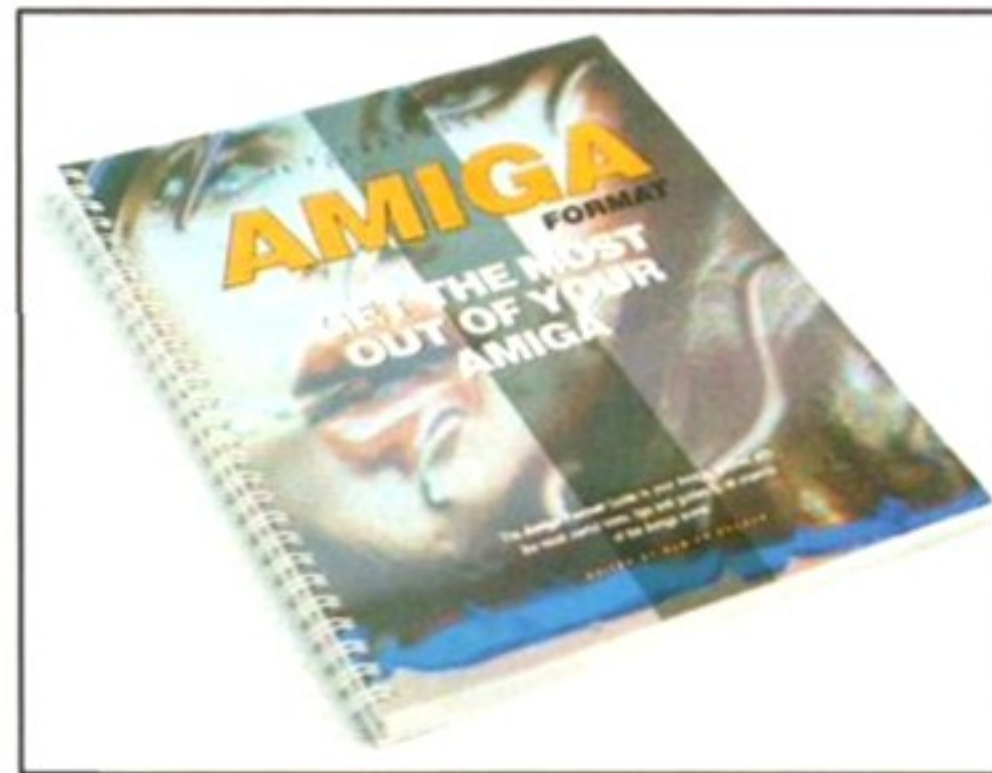

### Get the most...

*Get the Most out of Your Amiga* is possibly one of the most useful introductions to the Amiga. Written by *Amiga Format* Editor Damien Noonan, it contains much useful advice and many hints and tips.

Description	Price	Order No
<b>Book alone</b>	<b>£11.40</b>	<b>AM171</b>
<b>Book and Disks</b>	<b>£15.40</b>	<b>AM170</b>

# Amiga Format Mail order

The latest and greatest offers at simply the best possible prices.

AMIGA FORMAT

36

SEPTEMBER 1991

## Amos Compiler



**SAVE £8**



If you already own AMOS and you've been having success in creating your own programs, then this could be the one thing you're lacking. Run your programs through the compiler and they will be turned into 100 per cent machine code. Not only will they then run quicker, but also they are ready to run on their own as stand-alone programs. You will no longer need to put RAMOS, the AMOS run-time module, onto a disk to make your program work, saving around 150K of space and making life a lot easier! The Compiler also comes with the latest update to AMOS, version 1.3, so if you're behind the times you need to catch up! The update contains better facilities for hard drive users, Interlace support, speeded up graphics commands and more.

Description	Price	Order No
<b>Amos Compiler</b>	<b>£21.99</b>	<b>AM222</b>

## Amos 3D



**SAVE £10**



The only thing you can't do with AMOS as it stands is create 3D games – until now, that is! AMOS 3D is a special add-on for all AMOS users which will enable you to create three-dimensional objects and use them in AMOS. It includes a bunch of new commands with which 3D games, demos and whatever else you wish can be put together. The power centre of AMOS 3D is the Object Modeller, where you take basic 3D shapes and stretch them, squash them, colour them and stick them together to make whatever you want out of them. It's surprisingly easy to use and gives excellent results. For a full review of both AMOS 3D and the Compiler, as well as a look back at the story of AMOS, turn to Pages 114-117 of this issue.

Description	Price	Order No
<b>Amos 3-D</b>	<b>£24.99</b>	<b>AM223</b>



**FREE**  
DISKS OF THE LATEST  
PD SOFTWARE FROM THIS AD\*  
(WITH ANY PURCHASE FROM THIS AD\*  
(DEMOS UPDATED REGULARLY))

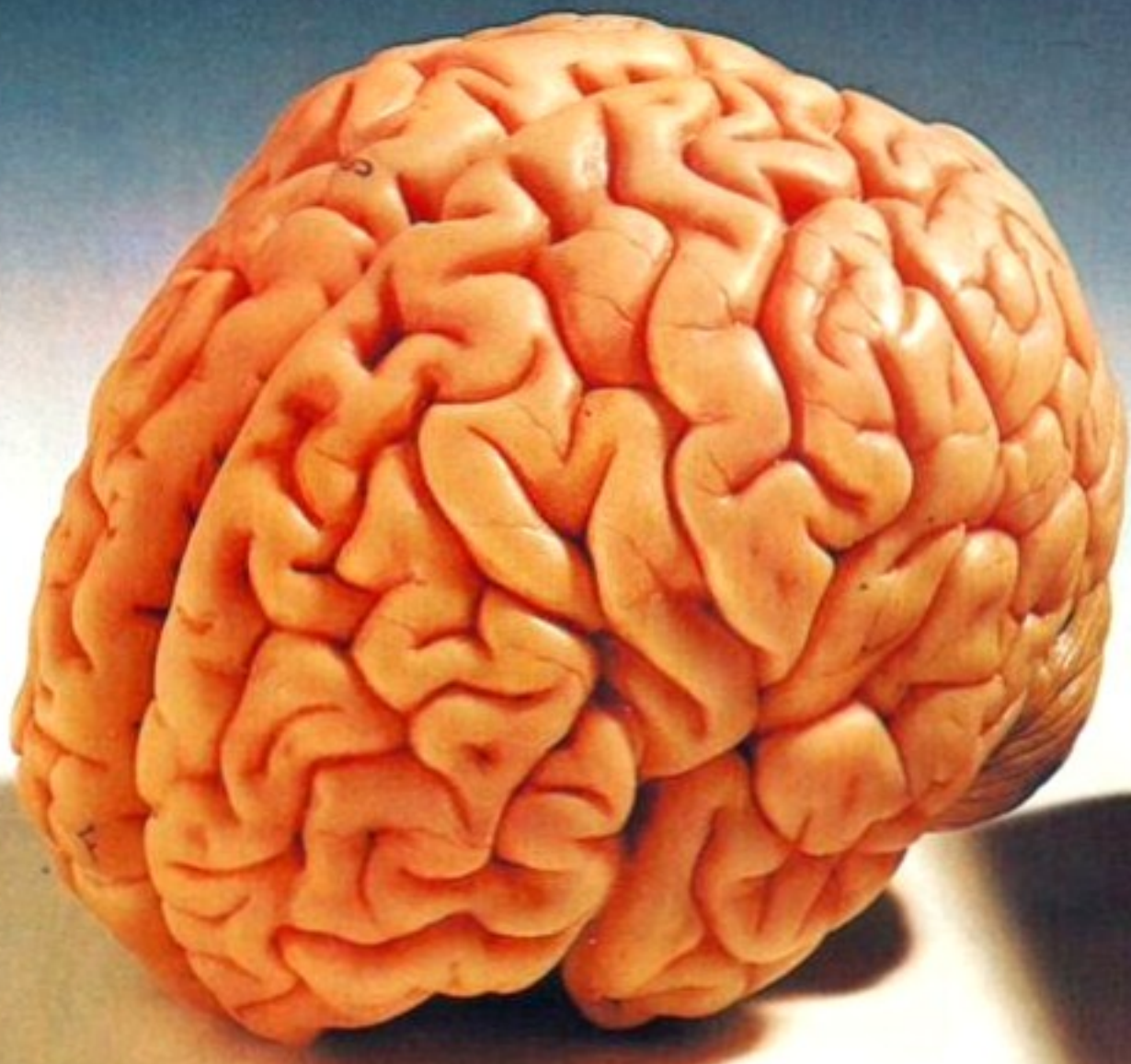

**A brain**

**The next best thing**

**CORTEX 8Mb RAM Expansion for the Commodore Amiga A500/A1000**

- External fitting. Warranty remains intact
- Fully implemented auto-configure
- Fully operational through-bus
- Uses standard 1M x 8 bit or 1M x 9 bit SIMMs
- Complete with its own power supply unit (UK, US or EURO)
- Designed with A1000 compatibility in mind
- Zero wait-states
- RAM test software



**Commodore Approved**

2Mb **£269** 4Mb **£349** 8Mb **£519**

**CORTEX 8Mb RAM Expansion for the Commodore Amiga A1500/A2000**

- Fully implemented auto-configure
- Zero wait-states
- Uses standard 1M x 8 or 9 bit SIMMs
- 2, 4, 6 or 8Mb configurations possible

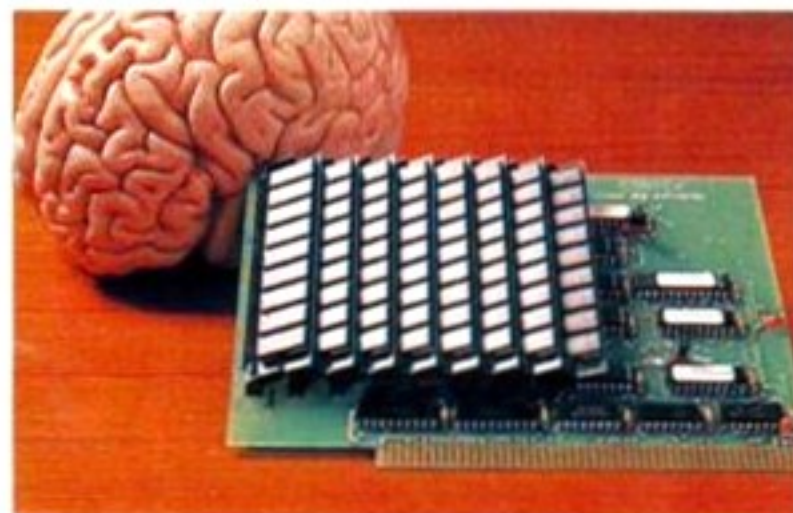

2Mb **£199** 4Mb **£289** 6Mb **£369** 8Mb **£449**

**CORTEX External 3.5" Floppy Drive**

- High-quality silent mechanism
  - Enabled/disable switch
  - Through port
- £59**

*"The Cortex unit is the best that has ever passed through my hands . . . This is THE board for the A500 user who wants memory."*

John Kennedy, Amiga User International, December 1990

*"What a joy! This really is an expansion and a half."*

Pat McDonald, Amiga Format, November 1990.

*"There is nothing in the universe more annoying than the lack of a through port, except perhaps the tendency of Volvo drivers to cut out in front of my GPz550."*

Nick Veitch, Amiga Computing, December 1990

**CORTEX 512K RAM Expansion for the Commodore Amiga A500**

- Low power 1 Mbit RAM chips
- Enable/disable switch
- "Fatter" Angus compatible for 1Mb Chip RAM
- Available with or without battery-backed clock/calendar module **£27.95**



Clock version **£31.95**

**CHIP UPGRADES**

1Mb Agnus Chip 8372A - Requires some technical skill to fit

	<b>£60</b>
Kickstart ROM upgrade version 1.3	<b>£35</b>
256K x 4bit DRAM chips (for CBM A590, CBM 2091, ICD Ad RAM, Ashcom etc)	<b>0.5Mb £25</b>
	<b>1Mb £49 2Mb £95</b>
A3000 Static Column Mode DRAM upgrade	<b>4Mb £269</b>
1M x 8 bit SIMMS for CORTEX 8Mb cards	<b>2Mb £90</b>
	<b>4Mb £175 6Mb £260</b>

*All prices include VAT and postage & packaging. Dealer enquiries are welcome.*



**Cortex Design Technologies Ltd., Britannia Buildings, 46 Fenwick Street, Liverpool L2 7NB, England.**

**U.K. Tel: (051) 236 0480 • 24 Hour Sales (051) 227 2482 • 24 Hour Fax**

★ Free software is limited to one set per order and is supplied without warranty

## The Gravis Mouse Stick™ The award winning joystick

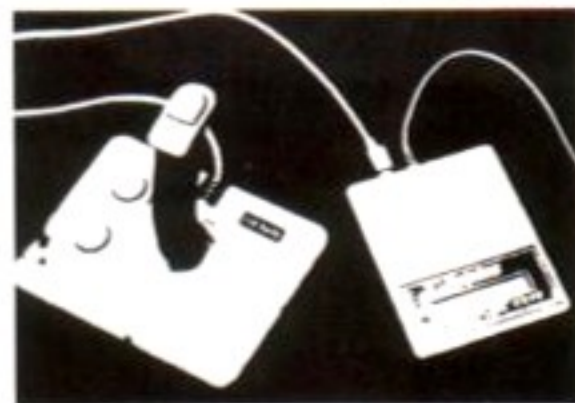

For sophisticated simulation enthusiasts, who demand PERFECT control, with programs such as Proflight, F19, Mig29, etc. A professional quality, programmable optical joystick C/W 16k microprocessor and L.C.D. screen offering 1200 line count resolution. Works perfectly with all simulations with sensible mouse routines and any others in its programmable joystick mode. No other joystick comes even close to the Mouse Stick for performance, reliability and pleasure in use.

For full technical support and 1 year guarantee.

S.A.E. or telephone for full details.

Telephone: (0272) 550900

Fax: (0272) 411502

*R.C. Simulations*  
Unit 1b Bee Hive Trading Estate  
Crews Hole Road  
St. George  
Bristol BS5 8AY

"YOU HAVEN'T HEARD OF US YET, BUT YOU WILL,  
WE ARE A NEW EXCITING COMPANY CALLING OURSELVES  
**"THE MECHANIX"**  
AND WE HOPE TO THRILL YOU WITH OUR NEW RANGE  
OF COMPUTER GAMES."

We are always looking for new exciting potential and games so this message is to all you part-time programmers: we wish to see your software. All material sent to us will be reviewed by our dedicated team of programmers, and if your software is of interest to our company you will be contacted by one of our team within 48 hours.

We will consider all games, utilities and demo's in any language from Assembly to Amos.

Please send your software to the following address:

**The Mechanix, Aprica House, Roughlea Terrace, Hunwick,  
Crook, County Durham, DL15 0LS Tel: 0388 662530**

Reach the top with..... **LCL**

Self-Tuition Courses

NATIONAL CURRICULUM\*

World leaders - Hons graduate/teacher authors - At all major shows - £5 off total for 2, £10 off for 3

NEW  
UPDATED  
VERSION

### MICRO MATHS

Complete course taking beginners to GCSE in 24 programs on 59 topics + a book and a manual. £24 (Amiga, ST, PC, PCW, CPC, BBC)

### READING WRITING COURSE

NATIONAL CURRICULUM

(A.T. 1-5) 24 program course teaching reading & spelling with a book and a manual and voice tape £24.

### PRIMARY MATHS COURSE

Complete course for ages 3-12 years with full screen colour graphics. NATIONAL CURRICULUM (Levels 1-4). 24 programs + a book and a manual. £24

### MICRO FRENCH

Complete course taking beginners to GCSE, with real speech & graphics adventure game, 24 programs + a book and a manual. £24 (Amiga & ST)

### MICRO ENGLISH

Complete course taking age 8 years to GCSE. Also for EFL. Now covers SPELLING, reading and oral. 24 programs and a book and a manual at £24 (Amiga, PCW, CPC, BBC).

### MEGA MATHS

A-Level step-by-step course of 24 programs. Full screen graphics for calculus. £24 (Amiga, CPC, BBC).

(\* LCL courses are compatible with the N.C. in so far as it has been finalised)

Send coupon and cheques/PO's or phone orders or requests for free colour poster/catalogue to:

**LCL (DEPT STF) THAMES HOUSE, 73 BLANDY ROAD,  
HENLEY-ON-THAMES, OXON RG9 1QB**

Phone now  
for immediate  
despatch

or ring 0491 579345 (24 hrs)

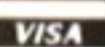

Name.....  
Address.....  
Title.....  
Computer.....

## Strategic Plus Software

**BANE  
OF THE  
COSMIC  
FORGE**

*(Wizardry)*

**State of the Art  
Role Playing**

11 Races with 14 Professions  
6 Spell Books with  
462 Combinations. Over  
400 Documented Items.  
A Huge Game!

Professional  
FOOTBALL  
SIMULATION  
V 3.0

**American Football  
at its best.**

The ULTIMATE in League play  
Create your own playbook  
MODEM play  
Even realistic weather  
Many more features than we  
can detail here.

### HARPOON

Battleset #2 "North Atlantic Convoys"

Battleset #3 "The Med Conflict"

and a Scenario Editor

## LATEST U.S.A. RELEASES

Flight Simulations - Strategy - Sports Simulations  
Role Playing - Wargames - Adventures

VISIT our SHOP in Hampton Hill  
or send £2.50 for our Extensive CATALOGUE.

Mail Order and Overseas orders welcome.

Phone 081 977 8088 Fax 081 977 4822

28 D&E The Courtyard, High Street, Hampton Hill, Middx. TW12 1PD.

Simple!  
Ingenious!

## TRACEY

Turn your mouse into a  
digitiser - for just £7.95!

Do you want to trace photographs and sketches into your DTP or graphics package? You need Tracey! This precision-moulded transparent puck attaches to your Amiga's mouse to give a quick visual guide of what you are tracing. Fixes to either side of the mouse for left or right handed use.

- ★ Removable when not in use
- ★ Ideal for Naksha, Commodore and all flat-sided mice
- ★ Only £7.95 including VAT and p&p

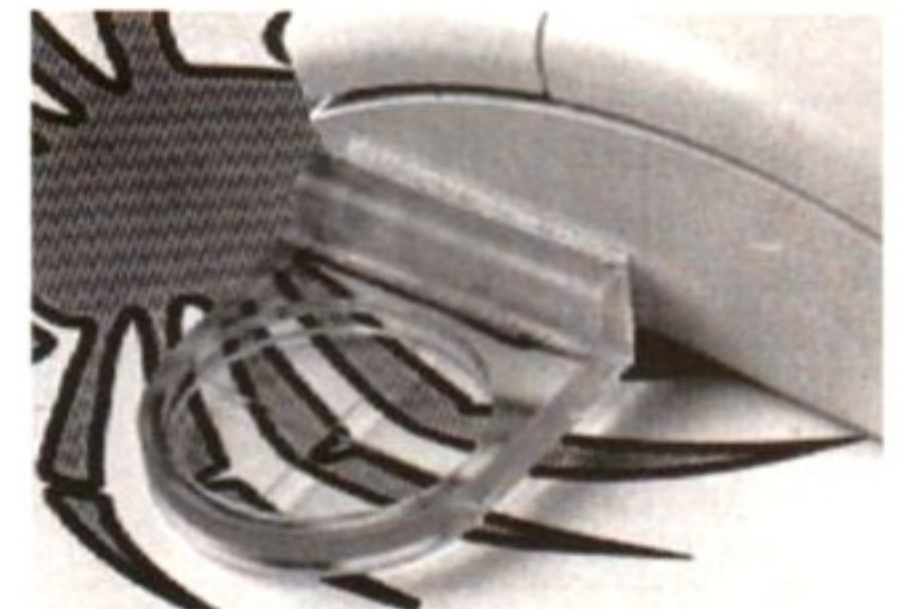

"This novel little device makes copying pictures easy" -  
*Amiga Format, Nov. '90*

"If the rule that all the simplest ideas are the best is applied,  
then Tracey gets the prize" - *Computer Shopper, Jan '91*

Cheque with order. Trade enquiries welcome.

**SideWise Ltd (Dept AF26), PO Box 4,  
Totnes, Devon TQ9 7EN**

# WeServe of Hampshire

Best for service

**Canon BJ-10e**  
360dpi Inkjet printer  
with cable & paper  
**£233.83 (£199.00 + VAT)**

**Panasonic**  
**KXP4420 761.40**  
KXP1180 149.23  
KXP1123 185.65  
KXP1124i 252.63  
prices inc. VAT cable & paper

**Amiga 1500**  
with Full software pack  
**£649.00 inc VAT**

**CBM 1084SD**  
with cable  
**£249.00 (£211.91 + VAT)**

**Philips CM8833 Mk2**  
with cable  
**£225.00 (£191.49 + VAT)**

**1Mb Cartoon Class**  
**£369.00 inc VAT**

**Class of 90's**  
**£439.00 inc VAT**

**Quantum 52M Disk**  
+Controller for A1500  
**£329.00 inc VAT**

**Accessories**  
Inc VAT  
Joystick/Mouse twin extension ..£4.70  
3M Joystick/Mouse 3M ext.....£3.75  
A500 Printer lead.....£7.95  
A500 to Philips CM8833 lead..£7.95  
Modulator/Disk Extension.....£10.95  
23 Way Plug or Socket.....£3.45  
A500 Dust Cover.....£4.70  
Mouse Mat (thick soft type).....£4.95  
A501 Memory Upgrade/Clock..£42.00  
KCS Powerboard 740K & IBM .£224.90  
Mouse House.....£2.95  
GVP Series 2 with 52M HD .£409.00  
IM Internal 3.5" drive .....£57.50

**Naksha Mouse**  
With house & mat  
**£21.50 inc VAT**

**Squick Mouse**  
**£14.50 inc VAT**

**1/2 Meg Ram + Clock**  
**£28.95 inc VAT**

Phone for Amiga Software catalogue.  
Many titles inc. Educational.

## Star

LC10 149.00  
LC200 199.00  
LC24 10 188.00  
LC24 200 244.40  
LC24 200 Col 299.00

prices inc. VAT cable & paper

**Printer Dust Covers**  
Most types in stock  
**From £4.70 inc VAT**

**Deskjet 500**  
H.P. 300dpi Inkjet printer  
3 year warrantee  
**£386.58**  
**(£329.00 + VAT)**

**Swift 24**  
2 year warrantee  
**£245.00 inc VAT**  
Colour kit with printer £24.00

**Citizen Swift 9**  
with cable & paper  
**£175.00 inc VAT**

**Citizen 120D+**  
with cables and paper  
**£128.00 (£108.94 + VAT)**

**Cumana CAX354**  
External 1Mb Drive  
**£56.95 inc VAT**

**A590 20Mb Hard Disk**  
**£269.00 inc VAT**

**DISKETTES**  
**SONY branded**  
(100% certified error free)  
Inc VAT  
10 3.5" DS/DD 135 tpi.....£7.50  
50 3.5" DS/DD 135 tpi.....£32.30  
100 3.5" DS/DD 135 tpi.....£59.93  
1K 3.5" DS/DD 135 tpi .....£540.50

**DISKETTES**  
**SONY bulk**  
**(lifetime warranty)**  
(100% certified error free)  
Inc VAT  
10 3.5" DS/DD 135 tpi .....£5.95  
50 3.5" DS/DD 135 tpi .....£19.80  
100 3.5" DS/DD 135 tpi .....£37.95  
250 3.5" DS/DD 135 tpi .....£82.25  
1K 3.5 DS/DD 135 tpi .....£309.23  
50 x 3.5" Disk Box with lock .....£5.99  
100 x 3.5" Disk Box with lock .....£7.50

Phone for our 40 page catalogue  
**EDUCATIONAL AND GOVERNMENT ORDERS WELCOME**  
All products have a 30 day money back & 12 month warranty.  
Prices subject to variation without prior notification.  
**Established 6 years.** We are closed Saturday afternoons.  
Free parking 2 minutes from M27 junction 11.  
Postage 94p (80p + VAT) Securicor £7.05 (£6.00 + VAT)

# WeServe

Amiga/F Dept  
40-42 West Street,  
Portchester, Hants.  
PO16 9UW  
Tel: 0705 325354



Larger items delivered  
by Securicor

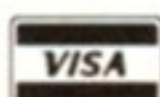

# ALL FORMATS COMPUTER FAIR

AMIGA, PC, ST, CONSOLES, 8 BIT. HUGE SAVINGS ON EVERYTHING COMPUTING

**NORTH** UNIVERSITY OF LEEDS SPORTS CENTRE,  
CALVERLEY STREET,  
CENTRAL LEEDS, **► SUNDAY 1st SEPTEMBER**

**LONDON** ROYAL HORTICULTURAL HALL,  
GREYCOAT STREET, WESTMINSTER  
(VICTORIA TUBE) **► SATURDAY 7th SEPTEMBER**

**MIDLANDS** NATIONAL MOTORCYCLE MUSEUM,  
SOLIHULL, J6 M42, BIRMINGHAM  
INTERNATIONAL STATION **► SATURDAY 14th SEPTEMBER**

**SCOTLAND** CITY HALL,  
CANDLERIGGS,  
GLASGOW **► SUNDAY 22nd SEPTEMBER**

**WEST** THE BRUNEL CENTRE,  
BRISTOL OLD STATION  
NEXT TO TEMPLE MEADS STATION **► SUNDAY 6th OCTOBER**



**Admission £4 Stands From Only £60**  
Book either with John Riding 0225 868100  
FAX 0225 868200

**ALL FAIRS 10am till 4 pm**  
AMPLE CAR PARKING AT ALL VENUES  
SHOW ORGANISER: BRUCE EVERISS

**ALL FORMATS COMPUTER FAIRS Newline 0898 299 389**

PROPRIETOR B. EVERISS-P.O. BOX 71-BISHOPS ITCHINGTON-CV33-0XS  
CALLS CHARGED AT 34p PER MIN CHEAP RATE & 45p AT ALL OTHER TIMES

# DATADISK

## LATEST FROM COMMODORE

### AMIGA A500 CARTOON CLASSICS 1Mb PACK

Amiga 500. TV Modulator. 512K Ram Expansion. Mouse

#### Software Includes:-

The Simpsons. Lemmings  
Captain Planet. Deluxe Paint II

**OUR PRICE £399.95**

### EXCELLENT VALUE ON BULK DISKS

3.5" DSDD (2 for 1 guarantee)				Sony DSDD			
10	25	50	100	10	25	50	100
<b>4.15</b>	<b>9.95</b>	<b>18.95</b>	<b>34.95</b>	<b>4.95</b>	<b>11.45</b>	<b>21.50</b>	<b>40.95</b>

RAINBOW DISKS 3.5" DSDD				RAINBOW DISKS 5.25" DSDD			
10	25	50	100	10	25	50	100
<b>5.95</b>	<b>12.95</b>	<b>25.95</b>	<b>44.95</b>	<b>4.15</b>	<b>9.95</b>	<b>18.95</b>	<b>34.95</b>

Branded-Sony 3M KAO £7 Box 10 | Bulk Branded KAO 100 £46

High density disks also available.

All disks 100% error free and are supplied with labels

A500 Basic Pack.....329.95  
Class of 90's First Steps.....469.95

#### Accessories

1/2 Meg expansion without clock..26.95  
1/2 Meg expansion with clock.....29.95  
External disk drive .....55.95  
External disk drive Cumana .....59.95  
Mouse Mat.....2.45  
Mouse Pocket.....1.45  
Amiga/Atari dust cover .....3.95  
3.5/5.25 Cleaning Kit.....1.95  
Naksha Mouse.....22.95  
Naksha Scanner .....149.95

#### Disk Storage

3.5 50 Capacity.....4.95  
3.5 100 Capacity.....5.95  
3.5 Barx Box.....8.95  
5.25 50 Capacity.....4.95  
5.25 100 Capacity.....5.95

#### Joysticks

Quickshot Apache .....6.95  
Comp Pro. 5000.....11.95  
Quickshot Maverick (Auto) .....12.95  
Konix Navigator (Auto).....12.95  
Logic 3 Manta Ray (Auto).....14.95  
Logic 3 Stingray (Auto).....15.95

**All prices include VAT. E&OE. P&P £3.50 Next Day £9**  
**UK mainland only**

Cheques/PO's etc payable to DataDisk, and send to:-  
**DataDisk, 15 Wivelsfield Rd, Brighton, BN2 8FP.**  
Enquiries call **0273 304747**

## AF BY MAIL

You can actually make life a lot easier for us and make certain of getting a reply if you make darned sure you're addressing your letter to the right person or place, so here's a guide to what to send where. We can never give personal replies by mail, so don't send us a stamped-addressed envelope: and we can under no circumstances give personal replies by fax.

## WORKBENCH

If you have any problems with the technical side of your Amiga, with hardware or with serious software, write to Pat and he'll try to answer you. Alternatively, if you have any advice for others or any handy tips to share, send it in and you could win a prize.

PAT MCDONALD, WORKBENCH,  
AMIGA FORMAT, 30 MONMOUTH STREET, BA1 2BW

## GAMEBUSTERS

If you've just found the cheat mode, mapped out the levels or found all the passwords for the latest game - whatever the game cheat, send it to Maff and you could win a prize. Also, if you're stuck somewhere, ask the Helping Hand section in Gamebusters for advice - or if you've read of a problem in Helping Hand that someone else has and you can solve it, then send in the answer to win a prize!

MAFF EVANS, GAMEBUSTERS (OR GAMEBUSTERS HELPING HAND), AMIGA FORMAT, 30 MONMOUTH STREET, BA1 2BW

## LETTERS

The Letters pages are for you to air your views and share your opinions: please remember not to ask questions that should be in Workbench! What Damien is looking for are thought-provoking or entertaining letters, if they're short there's a better chance they'll get in. Prizes for the best two. LETTERS, AMIGA FORMAT, 30 MONMOUTH STREET, BA1 2BW

## COMPETITIONS

To enter a competition, write the answers and your name, address and phone number on the back of a postcard or a stuck-down envelope and send it in. don't put several entries in together, or include entries with letters to any other part of the mag.

COMPETITION, AMIGA FORMAT,  
29 MONMOUTH STREET, BATH BA1 2AP

## AD PROBLEMS

If you have a problem with companies advertising in *Amiga Format* - you're cheque's been cashed but you've had nothing or whatever - our advertising department should be able to help. Write telling them briefly about the problem and which company it concerns.

AMIGA FORMAT ADVERTISING COMPLAINTS DEPT, FUTURE PUBLISHING, 30 MONMOUTH STREET, BATH BA1 2BW

## MAIL ORDER

If you've ordered anything from the *Amiga Format* Mail Order section and you've got a problem, please remember that we on the magazine don't deal with it at all. Write to them at our Somerton address or phone 0458 74011.

AMIGA FORMAT MAIL ORDER,  
THE OLD BARN, SOMERTON, SOMERSET TA11 7PY

## SUBSCRIPTIONS

Similarly, if you move house and want to make sure your copy of the mag catches up with you, then send the new address to AMIGA FORMAT SUBSCRIPTIONS, THE OLD BARN, SOMERTON, SOMERSET TA11 7PY

## FAULTY COVERDISKS

The disks are duplicated and stuck on the magazine by a firm who we employ for that specific purpose. If you have a faulty disk, send it to them enclosing an SAE. We don't keep stocks of disks, so we can't help.

DISKCOPY LABS, UNIT A, WESTMARCH, LONDON ROAD,  
DAVENTRY, NORTHANTS, NN11 4SA

## TEACHING US BY PHONE

The *Amiga Format* editorial team can only take enquiries from readers between 10.30am and 6.30pm on Tuesdays.

The Advertising department can help you with problems you may have with companies who advertise in the magazine if you call during normal office hours.

Our subscriptions service and the *Amiga Format* mail order department are not in the same building and should be contacted on 0458 74023.

# Letters

If you've got something to say, this is the place to say it. If you want to share your wisdom, lend the benefit of your experience or make a few waves, then get in touch. Keep it short, original and amusing and send it to **Letters, Amiga Format, Bath BA1 2BW.**

## USELESS INFO

Do you know that if you work 9-5, five days a week in front of a computer you spend 2,080 hours a year in front of a screen? "You might get square eyes," said the Auntie to the boy! Do I get a prize for that incredible piece of information?

MATTHEW LEAKE, POTTERS BAR

*No, you don't. But as I work about twice as much as that in front of a computer, you have reminded me to get one of those weird cacti that are supposed to soak up radiation. Anyone know if they work?*

## NICE TRY

If it's games immortalised in song you're looking for, then look no further than the album 'X 00 Multiplies' by Yellow Magic Orchestra. It has a track entitled 'Invader' which has no lyrics but includes sounds from *Breakout*, *Space Invaders*, *Boot Hill* and some more that I can't identify. The rest of the album's also worth a whirl if you like the idea of a Japanese Kraftwerk.

MARTIN SMITH, HOOKWOOD

*Thanks for the gen, but I don't really think it counts unless the name of a game is specifically mentioned in the words of a song.*

## CONVERT

For three years I saved up to buy an Archimedes until I had seven hundred pounds, and one day last year I walked into a shop with cheque book at the ready. Just as I was about to write the cheque, I heard the sweet sound of my favourite song, 'Hotel California', from across the room. I smiled and complimented the shop assistant on his good taste in music. "Yes," he said, "it's our Amiga 500." I stopped. "Hang on," I said, "computers can't make sound like that!" "Oh yes they can!" he replied.

Ten minutes later I walked out of the shop with an Amiga under my arm and £300 still in my pocket. My only regrets are that the Amiga is so goddamned ugly and that they have such a godawful reputation. Why do all other computer owners despise Amiga owners as gamesplayers who never do anything serious? I know, because I used to, but the Amiga is great as a serious computer as well.

DAVID WIGNALL, WEST LINTON

*I find it incredibly hard to believe that all other computer owners don't want to own an Amiga. I think it must be jealousy that makes them put the Amiga down. Probably the Amiga has something of a reputation as a games machine because it has a bigger range of games produced for it than any other, including the consoles. But we're also talking about the only truly multi-task-*

*ing home computer, the only one that has had stereo sound since launch, the only one that now gives you access to the latest in computing technology, such as 24-bit graphics. You can't get more serious! Right, I'm off for a game of Llamatron...*

## WHAT'S THE SECRET OF GOOD...

Why is it that *Deuteros*, previewed in the December 1990 edition with a claimed ETA of December, and reviewed in the April 1991 issue of *Amiga Format*, is not, according to *Amiga Power*, going to be released until late August!!! I was most upset when I trotted down to my local software store after reading the review only to find that I can't buy it. How does this sort of thing happen?

DARREN HOBBS, GERRARDS CROSS

*Timing! We are normally very careful to ensure that game reviews are in an issue of the mag that is out about the same time as the game. The trouble with this one, though, is that we reviewed it and sent the mag off to be printed just a few days before it was announced that Activision UK was to close. It seemed to take an age for *Deuteros* and the also-excellent *Hunter* to be released by Activision France, the new label established by the people who bought out the UK software house. Nothing we could do about that, I'm afraid. We were victims of circumstances.*

## COMEDY

Just letting you know that piracy rules the air. Just thought i'd tell you I ripp off the software industry. You, will here from me Again.

BOB

*I've printed this illiterate scrawl just as it appeared in Bob's letter. What a poor, sad, pathetic no-hope. Anyway, what air?*

## YOUR OPINION

A lot of the games that are being released at the moment are a load of rubbish. Although the games may seem good, with fancy graphics, they tend to be very short on lasting appeal.

BEN AND AL, ORPINGTON

*Ben and Al go on to list their favourite top ten, including such classics as Kick Off 2 and Stunt Car Racer. But where your argument falls down, guys, is that you've also got PGA Tour Golf and Indy 500 in there: these aren't exactly aged. I was recently telephoned by a trade computer magazine and asked what I thought of games in 1991, and though I have to agree with a few letter-writers who have said there's a lot of dross*

## SMD ENTERPRISES LTD

Amiga software

Armour Geddon.....£19.95	Killing Game Show...£19.95	Super Cars.....£19.50
Atomino.....£19.00	Lemmings.....£19.95	Swiv.....£19.50
Blasteroids.....£6.00	Moonshine Racers...£19.95	Ultimate Ride.....£19.50
Brat.....£19.95	Panza Kick Boxing...£19.95	White Sharks.....£18.00
Buggy Boy.....£7.99	Platoon.....£6.00	Xenon.....£5.95
Carrier Command.....£7.40	Rainbow Island.....£19.50	Xenon 2.....£19.50
Full Contact.....£7.00	Secret of Monkey Island	Joystick.....£10.50
Fun School 3.....£19.00	.....£19.95	1/2 Meg Ram Clock.....£29.95
Gods.....£19.95	Shadow Of The Beast	Disk Drive 3 1/2".....£70.00
Harley Davidson.....£20.99	.....£18.00	3 1/2 DSDD Disk + P+P
IK+.....£6.00	Speedball.....£19.50	.....£39.00

Many other titles and formats available.

Ring (0707) 375239.

Send cheque or postal order payable to:

SMD Enterprises Ltd. 53 Blythway, Welwyn Garden City, Herts, AL7 1DL

## SoftCentre

ESTABLISHED 1984

1 High Street  
Eastleigh  
Hampshire  
SO5 5LB  
TEL  
(0703)  
615542



# Mail Order Software

## 35% OFF R.R.P.

AMIGA & ST

WE GUARANTEE

- ★ 35% off RRP
- ★ All brand new stock
- ★ Despatch normally 48hrs
- ★ Prompt, no-fuss replacement of any defective title
- ★ P&P FREE for UK orders over £10 (UK under £10 add £1, elsewhere £2)

ALL LATEST RELEASES & POPULAR TITLES

Write / Phone for FREE LIST or Quotation (stating computer) or calculate yourself i.e. SoftCentre Price = RRP x 0.65

Cheque / Postal Order to Softcentre (cheque clearance allow 5 days)

VISA / ACCESS - number and expiry date

FAX (0703) 615583

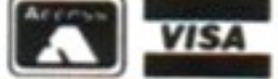

ENQUIRIES FROM  
8am - 8pm

## AMIGA & PC

MAIL ORDER ONLY  
NO CALLERS PLEASE

HARD DRIVES  
UNBEATABLE  
PRICES  
AVAILABLE

1/2 MEG  
UPGRADES  
£21.50

BLANK DISKS  
FROM 30P  
CALL FOR  
BULK PRICES

CALL FOR  
HARDWARE  
AND SOFTWARE  
PRICE LIST

20% OFF RRP  
MOST  
SOFTWARE

CALL FOR  
FREE  
PD CATALOGUE  
DISK

MG Computer Services, 74 Roach Road, Sheffield, S Yorks, S11 8UB  
TEL: 0742 682612 OR 654318 VAT Reg No. 534 1458 57

ALL PRICES INCLUDE VAT, CARRIAGE FREE ON ORDERS OVER £20



Free Game Offer



No purchase necessary

Free product guide

Excellent prices

Don't delay phone today



# Tronsoft

## Capital North Ltd.



Present

A 16-Bit

# COMPUTER EXHIBITION EXTRAVAGANZA



at the Leeds University Exhibition Centre, Calverley Street, Leeds 2.

Friday, 13th September, 10 a.m.-6 p.m.

Saturday, 14th September, 9 a.m.-8 p.m.

Sunday, 15th September, 10 a.m.-4 p.m.

BE SMART. BE THERE!

PLUS: Bring your spare computer equipment to sell at the Bring and Buy Counter. 10% Commission.

★ Car parking for 1200 ★ Refreshments available ★

See the latest software & hardware Thousands of bargains.

Stand Enquiries: Tel./Fax 0532 677657/610997



# AMIGA 500 MAMMOTH 1/2 MEG UPGRADE

**LATEST DESIGN INCORPORATES 'CHIPMEN' OPTION AT NO EXTRA COST!**

- Increases computer memory from normal 1/2 megabyte to 1 megabyte
- Includes disable switch/incorporates high quality silver coated pin connector
- 16 bit technology
- Fit in minutes
- Direct replacement of Commodore A501 expansion
- Includes "CHIPMEM OPTION" - Phone for details
- 12 month warranty
- In stock now!

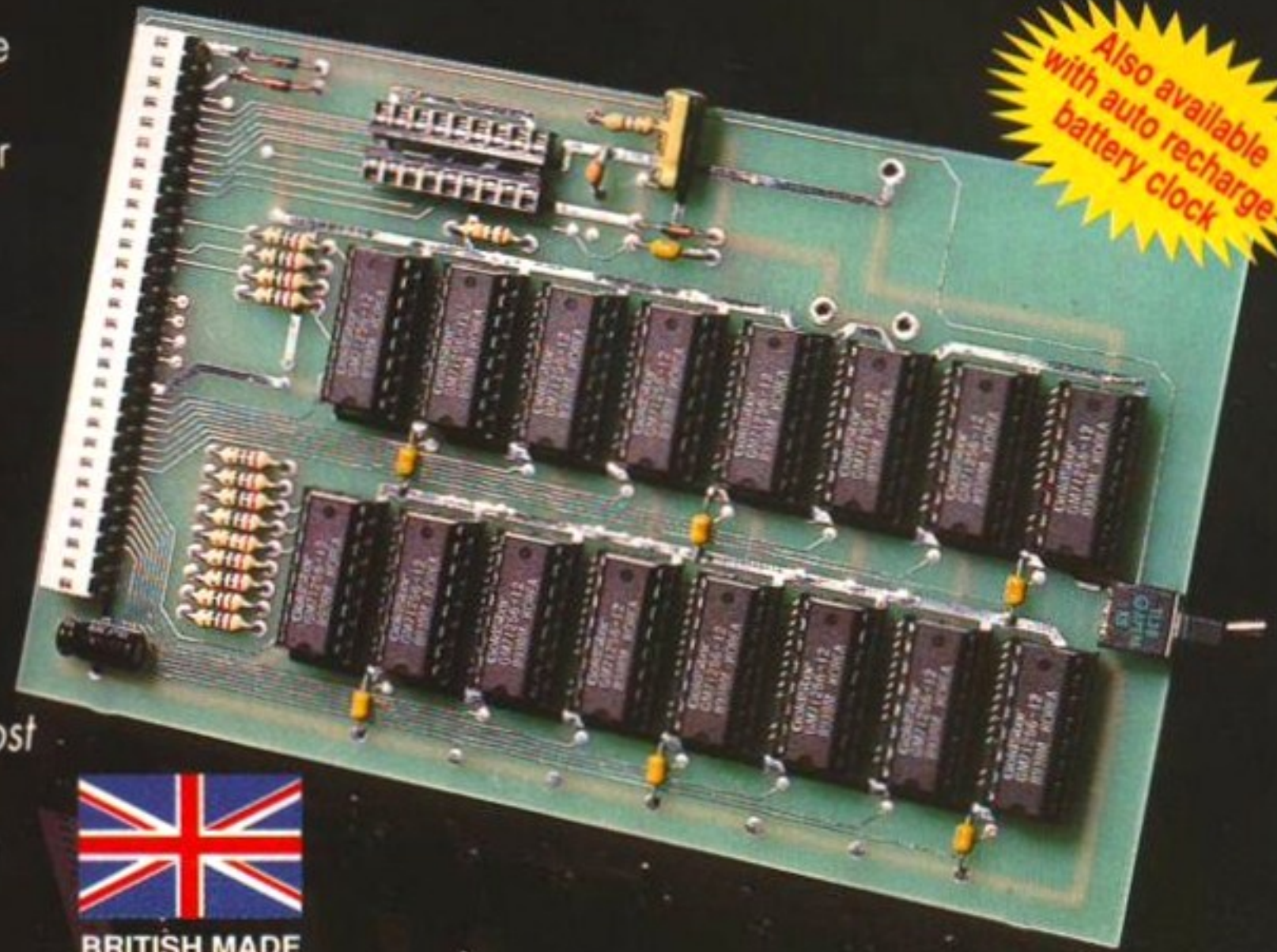

Also available with auto recharge battery clock

**£29.00**

Price includes VAT and post and packing

Tel: 0582 491949



Send order with payment to:

**WTS ELECTRONICS LTD**, Chaul End Lane, Luton, Beds LU4 8EZ



**Your computer is the only teacher which YOU CONTROL!**

**Whatever your age, whatever your subject - let your computer help you learn.**

Subjects include ...

**French, German, Spanish, Italian, English History, Geography, Science, General Knowledge, Football, First Aid, Sport, England, Scotland, Natural History, Junior Spelling and Arithmetic**

Available for most popular home & business computers



*Kosmos are specialist producers of Educational Software designed to help you enjoy learning from your computer. Our programs even allow you to add your own lesson material.*

**Write or telephone for a FREE 20-page BROCHURE** of our Educational & Leisure software  
Please state your computer type

Kosmos Software Ltd, FREEPOST (no stamp needed)  
DUNSTABLE, Beds. LU5 6BR  
Telephone 05255 3942 or 5406



## YOU MUST BE CRAZY

NOT TO BUY YOUR DISKS AT THESE PRICES EVERY DISKETTE 100% CERTIFIED 100% ERROR FREE

### DISKETTES

50 DSDD 3.5" .....£24.00    200 DSDD 3.5" .....£64.00  
100 DSDD 3.5" .....£36.00    500 DSDD 3.5" .....£155.00

3.5" High Density	5.25 DSDD	5.25HD
55p each	Only 25p each	Only 40p each

### STAR OFFER

★ 200 DSDD 3.5" **£72.00** ★  
Plus 2  
100 capacity boxes

### ACCESSORIES

50 capacity lockable box 3.5" .....£3.95    Mouse mats .....£2.95  
80 capacity lockable box 3.5" .....£4.50    3.5" head cleaner .....£2.95  
100 capacity lockable box 3.5" .....£5.50  
Banx Stackable box .....£8.95    **ONLY IF BOUGHT WITH DISKS**

**TOTAL SATISFACTION OR MONEY BACK**

ALL PRICES INCLUDE VAT & DELIVERY

**081-467-0131**

**DIAL A DISC**  
203 Southborough Lane,  
Bromley BR2 8AR

All offers subject to availability E/OE.

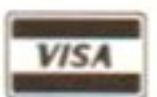

# MASSIVE PRICE REDUCTIONS

NOW EVEN BIGGER SAVINGS!!  
LOOK FOR THE\*

# TRILOGIC AMIGA

# Supermarket

ORDER

HOTLINE

0274-691115

## HOW TO ORDER

ALL PRICES INCLUDE VAT\* - NO HIDDEN EXTRAS  
(\*at 17 1/2% excluding books)

### CARRIAGE

CARRIAGE FREE ON ALL ORDERS!

Optional 1-2 day Express Delivery  
£3.50 per order or £7.00 for guaranteed next working day.

(UK mainland, exc. Scottish Highlands).

FREE NEXT DAY DELIVERY ON ORDERS OVER £500

EXPORTS a speciality - add £1.99 for surface mail or £3.99 for airmail. (Computers, monitors & printers - Please phone for carriage charges).

TO ORDER BY MAIL, PHONE OR FAX - Prompt Despatch

Simply quote your c/card details, name & address & your order & leave the rest to us. You are not charged until the goods are despatched. Or send cheque or PO (payable to TRILOGIC), or cash (send cash by registered post).

SALES ▶ 0274 691115

ENQUIRIES ▶ 0274 678062

FAX LINE ▶ 0274 600150

## TRILOGIC

Dept. A.F. Unit 1  
253 New Works Road  
Bradford, BD12 0QP



Established 1984

TRILOGIC

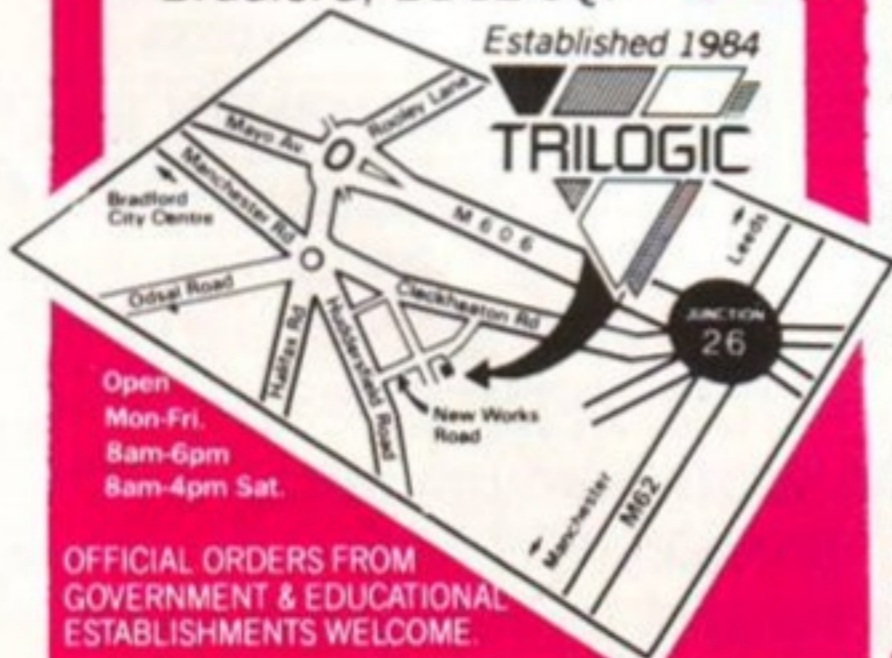

Open Mon-Fri. 8am-6pm Sat. 8am-4pm

OFFICIAL ORDERS FROM GOVERNMENT & EDUCATIONAL ESTABLISHMENTS WELCOME.

## THE DATAFLYERS

### UNBEATABLE VALUE FOR MONEY

#### THE DATAFLYER 500 RANGE

Our low cost high performance SCSI controller & hard drive units give your Amiga 500 real power. Similar styling to the AS90, plugging directly into the Amiga's expansion slot, they are available with or without a SCSI drive installed. Optional mains power supply available but rarely necessary in your experience. The built-in SCSI interface offers fast, autobooting performance (autoboot deferrable by holding down mouse button) at a low cost & is compatible with any SCSI drive. Installation instructions & utility disk included. 12 months warranty. Ready formatted - just plug in & switch on.

#### SCSI INTERFACE & HARD DRIVE HOUSING ONLY

ONLY £129.99

OPTIONAL MAINS POWER SUPPLY £54.99

WITH 40meg 28ms SCSI drive fitted ONLY £269.99

WITH 60meg 28ms SCSI drive fitted ONLY £419.99

WITH 83meg 24ms SCSI drive fitted ONLY £459.99

WITH 111meg 15ms SCSI drive & psu ONLY £599.99

Drives up to 177meg available. P.O.A. Please ask for separate Dataflyer leaflet. Managing your hard drive is easy with DISKMASTER only £34.99 when purchased with any Dataflyer.

#### THE DATAFLYER 2000 RANGE

Uses the same SCSI interface card as used in Dataflyer 500, but fits internally. Mounting holes drilled for most 3.5" SCSI drives. Available with SCSI hard drives fitted as listed below. All are Autobooting, have fast access times, & are self partitioning. An installation & utility disk for formatting & partitioning them is included. Up to 6 SCSI drives may be connected to one Dataflyer controller card. Ready formatted - just plug in & switch on.

SCSI interface card for Amiga 1000 & 2000 ONLY £79.99

SCSI card with 40meg 28ms SCSI drive ONLY £234.99

SCSI card with 60meg 28ms SCSI drive ONLY £375.99

SCSI card with 83meg 24ms SCSI drive ONLY £415.99

SCSI card with 111meg 15ms SCSI drive ONLY £499.99

Drives up to 177meg available. P.O.A. Managing your hard drive is easy with DISKMASTER only £34.99 when purchased with any Dataflyer. Please ask for separate Dataflyer leaflet.

#### BASEBOARD A500 MEMORY UPGRADE

The BASEBOARD is a very successful high quality memory upgrade card for your Amiga 500. It is compatible with 1.2 & 1.3 roms, & fat & faster Agnus chips. It accepts any 256K 4 Cmos Drams in 1/2 meg steps from 0 to 4 megs & auto configures to give you the full 1 meg chip ram. It has proved to be extremely compatible & reliable, though a disable switch can be fitted if required. An optional add-on board gives another 2 megs. No soldering is required, though some technical skill helps. Fitting the Gary adaptor invalidates the computers warranty. Comprehensive instructions supplied. 12 months warranty.

BASEBOARD unpopulated £89.99

XRAM 2 MEG ADDON CARD £79.99

BASEBOARD 12MEG £109.99

BASEBOARD 1MEG £129.99

BASEBOARD 2MEG £164.99

BASEBOARD 3MEG £199.99

BASEBOARD 4MEG £229.99

#### KSC POWER PC CARD

This fits in the 1/2 meg slot & boosts the Amiga's ram to 1 meg, with battery backed clock. Runs most PC software faster than on many XT's (runs over 120 sites including most well known PC programs). No soldering required, & does not invalidate the computers warranty. Supplied with MsDos 4.01 & Gw Basic. Latest version supports A590 & other hard drives. Comprehensive instructions supplied. 12 months warranty.

LOWER PRICE - NOW ONLY £229.99

#### OTHER HITECH UPGRADES

KICKSTART 1.3 ROM £29.99

FATTER AGNUS 8372A £69.99

8520A 10 CHIP £15.99

UPDATED A500 POWER PACK £44.99

A520 MODULATOR £24.99

FLICKER FIXER FOR 1500/2000 £299.99

FLICKER FIXER FOR A500 £299.99

SUPRA 8 MEG MEMORY CARD FOR AMIGA 1500/2000 £109.99

Unpopulated - Uses 256K 4 Drams, in 2.4, 6 or 8 meg stages

CMOS 256K 4 DRAMS - from £33.00 per meg

23W PLUG & COVER £2.99

23W SOCKET & COVER £2.99

#### DRIVE SWITCHES & ADAPTORES

DRIVE SWITCH 1 for disabling external DF1. Fits between the drive port & drive connector. £10.99

BOOT SELECTOR SWITCH. Fits internally, & enables boot drive to be the external drive. Disables the internal one completely - i.e. the internal one cannot be 'swapped' for the external one. £16.99

CYCLONE COPIER ADAPTOR fits between drive & Amiga drive port, needs Cyclone software to work (included free with Kcopy II) £79.99

#### QUALITY DISK STORAGE BOXES - LOCKABLE TINTED LID. ANTISTATIC

3.5" DISK LIBRARY CASE for 10 Disks £1.49

40 SIZE £6.99

80 SIZE £7.99

100 SIZE £8.99

150 SIZE Posso Stackable Drawer Type £18.99

250 SIZE £24.99

Special Offers

50 SIZE BOX + 10 Sony Disks - Only £11.99

100 SIZE BOX + 25 Sony Disks - Only £19.99

150 SIZE BOX + 50 Sony Disks - Only £43.99

#### SONY BULK 3.5" DS/DD DISKS + FREE LABELS

PACK OF 10 £6.99

PACK OF 25 £14.99

PACK OF 50 £24.99

PACK OF 100 £44.99

BOX OF 500 £209.99

Sony branded disks - add 50%

#### PRESENTATION, PAINTING & ANIMATION

MOVIESETTER £59.99

IMAGINE £174.99

VIDEOSCAPE 3D £99.99

DISNEY ANIMATION STUDIO £89.99

DIGIPANT 3 £49.99

DELUXE PAINT III £59.99

FANTAVISION £14.99

ALL PRICES INCLUDE VAT - NO HIDDEN EXTRAS

## DESKTOP VIDEO PERIPHERALS

DIGIVIEW GOLD V4 £99.99

VIDI + VIDICHROME SPECIAL PRICE £99.99

RGB SPLITTER FOR VIDI £59.99

HITACHI MONOCHROME CAMERA £209.99

MINIGEN £104.99

RENDALE 8802 £174.99

RENDALE SUPER 8802 P.O.A.

G2 VIDEO CENTRE £759.99

COLOURPIC £389.99

SUPERPIC £485.99

DIGIVIEW 4 + DIGIPOINT 3 av £129.99

## VIDEO TITLING

VIDEO TITLER 3 (2 drives & 1meg req'd) £109.99

DELUXE VIDEO £79.99

PIXMATE £34.99

BROADCAST TITLER 2 (2Meg req'd) £124.99

## CAD & DRAWING - 2D/3D

X CAD DESIGNER £79.99

PROFESSIONAL DRAW 2.0 £94.99

SCULPT 3D XL 1meg minimum £99.99

SCULPT ANIMATE 4D JUNIOR £79.99

## VIDEOS (VHS FORMAT ONLY)

TRILOGIC'S INTRODUCTION TO THE COMMODORE AMIGA 500 Part 1

Covers all the first time Amiga A500 user needs to know including unpacking it, connecting the modulator & mouse, copying workbench, connecting external disk drives, peripherals & memory expansions well worth £14.99 or free with any Amiga purchased from us. Also serves to show just what can be done with an Amiga. G2 genlock, some software & home video equipment. 1 Running time: approx 30 min. £10.99

PROFESSIONAL TECHNIQUES FOR DPAINT III A 60 minute video showing you step by step how to use DPaint III's more advanced & spectacular features. £19.95

## MONITOR PLINTHS & STANDS

MONITOR PLINTH 1 Simple but effective.

This is a steel plinth which fits over the Amiga upon which most monitors & small tv sets. £24.99

MONITOR PLINTH 2 With Shelf for External Disk Drive etc. This is similar to the Amiga Control Centre - it fits over the Amiga with a slot for the disk drive, & a shelf under the monitor for external drives. Open backed. £34.99

MONITOR PLINTH MOUSE JOYSTICK £7.99

EXTENSION LEAD KIT PER PAIR £7.99

MONITOR SWIVEL/TILT BASE for 12 to 14" tvs & monitors £17.99

## AMIGA TV & MONITOR LEADS

If your tv has an RGB input, you will get a much clearer picture connecting the Amiga to this using one of our leads, rather than via the modulator. All our monitor leads give the full range of colours, & include the audio leads unless otherwise stated.

AL1 AMIGA to scan - works with most scan equipped tvs & monitors, including Sony, Philips, Normande, Ferguson, Toshiba Mitsubishi, ITT etc. £12.99

AL2 AMIGA to Ferguson with 7 or 8 pin Din socket eg MC01 £12.99

AL4 AMIGA to Hitachi/Grande with 7 pin Din socket £12.99

AL6 AMIGA to Amstrad CPC colour monitor with 6 pin din plug, no audio. £11.99

AL7 AMIGA to 1084s monitor with 6 pin din socket & two phono sockets (audio) £14.99

AL7P AMIGA TO PHILLIPS 8833 MK2 £14.99

AL7D AMIGA to 1084s D monitor with 9 pin D socket & two phonos £14.99

AL8 AMIGA to CGA monitor - 16 colours, no sound, 9 pin D plug. £11.99

AL11 AMIGA to Multisync monitor with 9 pin D socket, no audio. £11.99

AL12 AMIGA to Multisync monitor with 15w 3 row D socket, no audio. £13.99

AL13 Amiga to Multisync monitor with 15 pin 3 row D plug, no audio. £13.99

AL15 AMIGA to 'taken with 8 pin EIA connector, no audio. £15.99

AL16 AMIGA to 'staying TM01 colour monitor, no audio. £11.99

MODULATOR EXTENSION LEAD. Enables the modulator to be moved - reduces its overhang & makes for a more secure connection. £10.99

MODULATOR SPLITTER. Enables the modulator & monitor lead to be connected at the same time - the modulator is required if you wish to tape the Amiga on a VCR. £16.99

GENLOCK SPLITTER. Enables a genlock & monitor lead to be connected at the same time. £19.99

Longer Leads can be made to order - add £1.50 per metre to the list price.

## SCART SWITCHES TV - MONITOR SHARERS

TV/MONITOR SHARER A for Scart tvs & monitors

Converts one scart socket into two - switch selects input one or input two. Wired for RGB & composite - stereo sound - suitable for home computers, vcrs & satellite receivers. £19.99

Plugs into the scart socket of your tv or monitor

Dual scart sockets for two computers or \* Computer + VCR or \* Computer + satellite receiver etc.

Push button switch selects input 1 or input 2

No additional leads required - your existing scart leads just plug into the sharer.

## PRINTER ACCESSORIES

2 WAY PRINTER SWITCH (25w D sockets) £24.99

3 WAY PRINTER SWITCH (25w D sockets) £27.99

4 WAY PRINTER SWITCH (25w D sockets) £33.99

2 WAY CROSSOVER (25w D sockets) £34.99

2 WAY PRINTER SWITCH (36w sockets) £26.99

3 WAY PRINTER SWITCH (36w sockets) £29.99

4 WAY PRINTER SWITCH (36w sockets) £34.99

CONTINUOUS 60gsm PAPER 11 "9.5" Box of 2000 Micropert Margins £21.99

CONTINUOUS 80gsm PAPER 11 "9.5" Box of 1750 Micropert Margins £31.99

PACKS OF 500 SINGLE SHEETS. A4 60gsm white £5.99

A4 60gsm blue, green, yellow, or red £9.99

Prices are up to £4.00 box cheaper to caterers because of savings in postage.

CONTINUOUS LABELS 89 "39mm, 1 across, pack of 1000 £8.99

COPY HOLDER Free standing type £17.99

COPY HOLDER Table top edge clamping type £17.99

PRINTER STAND standard width £13.99

PRINTER STAND for wide carriage printers £15.99

## AMIGA PRINTER & MODEM LEADS

### FOR A500/2000/3000

AMP1 AMIGA to parallel printer, approx 1.5m long £9.99

AMP2 AMIGA to parallel printer, approx 3m long £12.99

AMP5 AMIGA to parallel printer, approx 5m long £16.99

MF1 25way male to female lead, approx 1.5m £11.99

MF2 36way male to female lead, approx 1.5m £12.99

MM1 25way male to male lead, approx 1.5m £11.99

MM2 36way male to male lead, approx 1.5m £12.99

NML3 Null modem lead for linking 2 Amiga £8.99

ML1 25way female to male modem lead, approx 1.0m £11.99

ML2 25way female to din plug modem lead - state modem £10.99

ML3 Designer modem lead £11.99

BEU1 BBC Emulator lead, 25way to 5 pin domino plug £8.99

ASPI AMIGA serial printer lead, 25way male/female £11.99

## PRINTER RIBBONS (COMPATIBLE TYPES)

STAR LC2410 £6.99

STAR LC10 £4.49

STAR LC10 COLOUR £6.99

CITIZEN 1200/1200-780E £4.49

CITIZEN 1200/1200-780E CITIZEN BRAND RIBBON £6.99

COMMODORE MPS801 £5.99

COMMODORE MPS803 £3.99

PANASONIC KXP1081 £4.49

PANASONIC KXP180/124 £4.49

AMSTRAD DMP2000/3000/3160/3250 £3.49

Buy 3 get 1 free.

## SAMPLING

AUDIOMASTER III £54.99

PERFECT SOUND inc budget Stereo sampler £52.99

MASTERSOUND INC budget mono sampler £41.99

Special Offer

AUDIOMASTER III + TRILOGIC STEREO SAMPLER 2 save £19.00 £64.99

## SEQUENCING COMPOSING = MIDI COMPATIBLE

QUARTET\*\* £44.9



# AMIGA 500

1 MEG VERSION  
FROM **£329.99**

- AMIGA 500 WITH 1.3 WORKBENCH
- 1 MEG RAM • TV MODULATOR
- BUILT-IN 3.5" DISK DRIVE
- ALL MANUALS & CABLES
- MOUSE • FREE VIDEO!

**FREE VIDEO** This highly acclaimed video, produced by us, especially for first time Amiga buyers, takes you through everything from connecting up your Amiga backing up Workbench, formatting disks, installing 1/2meg expansions & other peripherals + demos of other Trilogic products. Free with any Amiga pack, or available separately for £14.99 + 75p postage.

- PACK 1**
- AMIGA 500 WITH 1.3 WORKBENCH
  - 1 MEG RAM • TV MODULATOR
  - BUILT-IN 3.5" DISK DRIVE
  - ALL MANUALS & CABLES
  - MOUSE • FREE VIDEO!
- PLUS**
- SHADOW OF THE BEAST II
  - BACK TO THE FUTURE II
  - DAYS OF THUNDER • DELUXE PAINT II

**PACK 1 ▶▶▶▶ £369.99**  
1 MEG VERSION

**10 STAR PACK ONLY £30** when purchased with an Amiga

- 5 SONY DISKS + LABELS
- QUALITY MOUSE MAT
- MICROSWITCH JOYSTICK
- 10 GREAT GAMES WORTH OVER £339.00
- TAILORED DUST COVER
- DATASTORM DUNGEON QUEST
- E-MOTION
- GRAND MONSTER SLAM
- KID GLOVES
- POWERPLAY
- RVF HONDA
- SHUFFLEPUCK CAFE
- SOCCER
- TOWER OF BABEL

**PACK 2** **PACK 1 PLUS PHILIPS CM8833 mk 2 COLOUR MONITOR**

- CONNECTING LEAD • RGB & VIDEO INPUTS
- MED RESOLUTION • OVER 4096 COLOURS
- TWIN STEREO SPEAKERS • 14" SCREEN
- STEREO HEADPHONE SOCKET
- GREEN SCREEN SWITCH

**PACK 2 ▶▶▶▶ £599.99**

## MONITORS ◀◀ FREE LEADS!

**PHILIPS CM8833 Mk2 £239.99**

- 14" SCREEN • HIRES, 41mm DOT PITCH
- STEREO HEADPHONE SOCKET
- COMPATIBLE WITH AMIGA, ATARI ST, C64, PC (CGA) VCRs ETC. • TWIN STEREO SPEAKERS
- PHILIPS GREEN SCREEN
- 12 MONO MONITOR £89.99

**COMMODORE 1084S £269.99**

Similar spec & picture quality to the 8833

## HI-RES MONITORS

**INTERQUAD MS1480 £349.99**  
**AOC CM326 £369.99**

- VERY SHARP & EASY TO READ
- MULTISYNC/MULTISCAN
- BUILT IN TILT/SWIVEL BASE
- COMPATIBLE WITH AMIGA, ST, PC/AT/MAC II
- LEAD INCLUDED (STATE COMPUTER)
- 14" NON GLARE SCREEN
- 028MM DOT PITCH • 1024 x 768 PIXELS
- (NO SPEAKERS FITTED USE ONE OF OUR MINIAMP STEREO SYSTEMS OR YOUR HIFI)
- FLICKER FIXER COMPATIBLE

## 1/2 MEG UPGRADE

(WITHOUT CLOCK & BATTERY) **£26.99**

~~£33.99~~

- CLOCK & BATTERY
- ON/OFF SWITCH
- EASY TO FIT
- ALL CHIPS SOCKETED
- DOES NOT INVALIDATE THE A500 WARRANTY



(WITH CLOCK & BATTERY) **£37.99** **£29.99**

## A590 HARD DRIVE

Available with up to 2meg of ram installed **£289.99**  
**WITH 1 MEG RAM £319.99**  
**WITH 2 MEG RAM £349.99**

The A590 offers 20 megabytes of disk storage + up to 2 megs of fast ram. It is autobooting — so you won't need to use the workbench disk again. Complete with power supply. Post free.

**ORDER HOTLINE 0274 691115**

SEE OPPOSITE FOR HOW TO ORDER

## PRINTERS ◀◀ FREE LEADS, DUST COVER & DRIVER DISK

**STAR LC10 £154.99**

9 pin head, 4 fonts, 144 cps draft, 36 cps NLQ, condensed, double & quadruple sizes, 240dpi graphics, single or continuous sheets

**STAR LC200 £209.99\***

New 9 pin colour printer replaces LC10 colour

**STAR LC24-200 £259.99\***

New 24 pin printer which replaces the LC24-10 printer

**STAR LC24-200 colour £314.99\***

Completely new 24 pin colour

**STARSCRIPT LASER 4 £1299.99**

4ppm Postscript Laser Printer, With 2mb ram, 300x300 dpi, Epson or HP Laserjet 2 Compatible. 12 months on-site warranty.

**CITIZEN 120D+ £144.99\***

Good budget 9 pin printer.

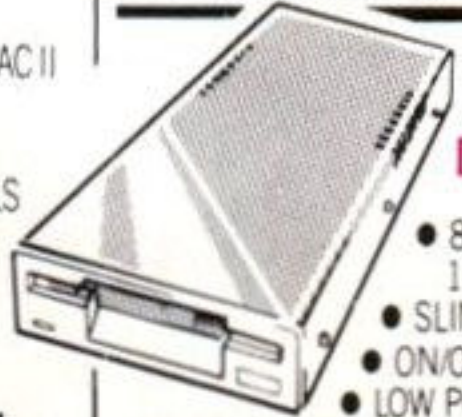

**EXTERNAL 3.5" DISK DRIVE £54.99**

- 880K FORMATTED 1 MEG UNFORMATTED
- SLIMLINE CASE
- ON/OFF SWITCH
- LOW POWER CONSUMPTION

- THROUGH PORT FOR CONNECTION OF ADDITIONAL DRIVES
- EXTREMELY QUIET OPERATION
- VERY RELIABLE MECHANISM

ALSO AVAILABLE...

**QTEC AMIGA 3.5" DRIVE £64.99**

**QTEC AMIGA 5 1/4" DRIVE £99.99**

**INTERNAL REPLACEMENT DRIVE (Chinon type only) £79.99**

**CUMANA CA x 354 £69.99**

## LOW COST A590 DRIVE UPGRADES

Why not upgrade your A590 with a larger, faster AUTOBOOTING & SELF-PARKING SCSI drive. Our direct replacement hard drives simply fit in place of the original unit, and are easy to format and partition with the original A590 installation disk. Instructions supplied.

**49 MEG 28ms £249.99**

**60 MEG 28ms £299.99**

**83 MEG 24ms £339.99**

**111 MEG 15ms £399.99**

Free DISKMASTER worth over £34.99

For alternative larger ready built Amiga 500 hard drive units, see our DATAFLYER range on opposite page.

\*REDUCED PRICES! BIG SAVINGS!

# SOFT EXCHANGE

Offers you the best in prices, quality and service.

We will beat any advertised price in this magazine. All our diskettes are of high quality Japanese media.

Probably the best unbranded disks available in the UK.  
3 1/2" DSDD 100% certified error free

10 .....	£4.99	20 .....	£8.49	30 .....	£12.49
40 .....	£15.49	50 .....	£18.99	100 .....	£33.99
150 .....	£49.99	200 .....	£63.99	300 .....	£94.99
400 .....	£123.99	500 .....	£154.99	1000 .....	£289.99

Including Labels

## SPECIAL OFFERS

10 Disk + 80 Cap Box .....	£9.99
20 Disk + 80 Cap Box .....	£12.99
30 Disk + 80 Cap Box .....	£17.99
40 Disk + 80 Cap Box .....	£20.99
50 Disk + 80 Cap Box .....	£23.99
100 Disk + 100 Cap Box .....	£39.99
200 Disk + 2x100 Cap Box .....	£69.99

Including Labels

## ACCESSORIES

40 Cap Lockable Box .....	£5.99	80 Cap Lockable Box .....	£6.99
100 Cap Lockable Box .....	£7.99	Mouse Mat .....	£2.99
Disk Labels 50 .....	£1.50	Disk Labels 100 .....	£2.50
Disk Labels 500 .....	£9.99	Universal Printer Stand .....	£8.99
Disk Head Cleaner 3 1/2 .....	£2.99	Dust Cover Amiga/Atari (Keyboard) .....	£4.47
Dust Cover 12" Monitor .....	£4.99	Dust Cover 14" Monitor .....	£5.99
Logitech 2 Button Mouse .....	£26.99		

**KAO Branded Disk Box of 100 .....** £45.99

All prices include VAT, post and packing in UK, overseas orders please write or telephone. To order please send Cheque/P.O. made payable to

# SOFT EXCHANGE

101 Clifton Road, South Norwood, London SE25 6QA  
Tel: 081 653 9094 (24 HRS ORDER LINE) ACCESS/VISA ACCEPTED.

All above offers close 30.09.91.

Government and Educational orders quoted at very competitive prices.

Announcing...

# POOLSWINNER Gold

THE POOLS PREDICTION PROGRAM WITH ARTIFICIAL INTELLIGENCE

- THE LEGENDARY POOLS PREDICTION AID, Poolswinner, now has artificial intelligence. The latest version of the program, Poolswinner Gold, has the power to learn from the results of its own predictions, constantly adjusting the prediction formula to improve performance.
- AUTOMATIC FIXTURE GENERATION: Fixtures for English and Scottish League matches are generated automatically by Poolswinner Gold, which now incorporates its sister program FIXGEN 91/92 (yearly updates are available from Selec).
- MASSIVE DATABASE: 22000 match database over 10 years.
- PREDICTS SCOREDRAWS, NO-SCORES, AWAYS and HOMES. Predictions are based on many factors .. recent form, the massive database, league standing, goal scoring rates, and draw averages. The user can adjust all parameters.
- SUCCESSFUL Selec guarantee that Poolswinner performs significantly better than chance.
- LEAGUE AND NON-LEAGUE matches are covered. Can be used for the non-league and amateur matches so often on the coupon now.
- FULL LEAGUE TABLES (home & away) are automatically generated by the program as results come in.
- UPDATED WEEKLY. Poolswinner Gold is supplied fully updated with all league results from the start of the season - its ready for immediate use.
- PACKAGE CONTAINS disc, detailed operating manual and support literature, all you need to start forecasts immediately.



£36.50

Also available from Selec...

**COURSEWINNER V4 £36.50**

THE PUNTER'S COMPUTER PROGRAM. Uses artificial intelligence. Uses past form, going, distance, speed ratings, prize money etc. Contains British course statistics - best jockeys, trainers, draw effect etc. Detailed analysis of all runners in a race, with profit. Sophisticated aid to successful betting, with a long pedigree.

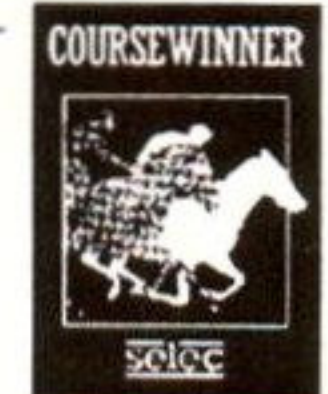

**POOLS PERM PLUS £32.50**

Perm analyser and checker, complete with 5 years of coupon results and popular perms for analysis. Checks your weekly entry for winning lines, or tests your theories on results over the last 5 years. Reveals all the weeks a bet would have won, and the probable dividend.

**FOOTBALL FOLLOWER £32.50**

Statistical analysis for Football enthusiasts. Tables, fixture lists, sequences etc. Set up for British League football, but can be set up by the user for any league - amateur etc. Ideal for all fans, league secretaries etc.

All programs are supplied on disc, packaged with detailed instruction manual, and support literature. Formats available:  
IBM (3.5" or 5.25")  
AMIGA  
ATARI ST  
AMSTRAD PCW  
Prices are inclusive of VAT & delivery

Send cheque / PO for return of post service to ...

**Selec Software** (Est. 1984)

62 Altrincham Rd, Gatley, Cheshire SK8 4DP  
(send for full list of our software)



Tel 061-428-7425  
Phone or FAX 24 hrs

# RICHARDS DEVELOPMENTS

1/2 Meg Amiga upgrades no clock includes on/off switch .....£19.95  
4D-Ram Version

1/2 Meg Amiga upgrades with clock and switch .....£24.95  
4D-Ram Version

\*\*\*\*\* **SPECIAL LAUNCH OFFER** \*\*\*\*\*

Amiga 1.5 Meg upgrades fully populated, includes clock,  
easy fit runs off Gary Chip, requires 1.3 version.

5 year warranty free 2 Mb demo.

ONLY £69.95 inc VAT

\*\*\*\*\*

3.5" Disks DD/DS 100% error free .....1-49 .....35p each  
49-99 .....31p each  
100+ .....28p each

**ALL DISKS INCLUDE FREE LABELS**

40 Cap locking disk box 3.5" .....£3.99 each  
80 Cap locking disk box 3.5" .....£4.99 each

Null modem lead for back to back communications .....£3.99 each  
Amiga 4 player adaptor lead .....£4.99 each  
Joystick extension lead .....£4.99 each  
Amiga dust cover .....£2.99 each  
Mouse mat top quality .....£1.99 each

**ALL PRICES INCLUDE VAT, POSTAGE AND PACKING IS EXTRA  
PLEASE ASK WHEN ORDERING.**

**CREDIT CARD HOTLINE - 0602 464188**

*Cheques/Postal Orders to:*

**RICHARDS DEVELOPMENTS, 14 Windmill Way, Kegworth,  
Derby DE7 2FA. Please phone first for price of postage.  
ALL PRODUCTS CARRY A FULL 5 YEAR WARRANTY  
Public Domain also available all disks only 99p plus p+p  
For full catalogue send £1.00**

# THE SILICON PICTURE COMPANY FULL COLOUR

**WELL, AT LEAST ALL 4096 COLOURS THE AMIGA CAN DISPLAY**

Using over £30,000 of the latest print technology we can produce a full colour print, T-Shirts & sweatshirts using the Amiga's full 4096 colour palette, we **DO NOT** use dot matrix or inkjet printer but the Cyan, Magenta, Black, Yellow process as used in full colour printing, the prints are taken directly from the Amiga screen giving you the full 4096 colour palette. (Coming soon full 24 bit output).

**WHAT TO DO**

As we have said, these prints are taken directly from the screen, which means you will need to frame your picture with a black border, this is what you do in **LOW RES**: make a border of 10 pixels top, 5 left & right and from the bottom of the screen up 25 pixels (Selecting Co-ords from your paint package helps). **MED RES**: 10 pixels left, right, top & 25 bottom. **HIGH RES**: 20 pixels top, 10 left & right & 50 bottom. **HAM** Same as Med Res. Then all you need to do is send us your disk giving instructions, what size you require (A4, A3, T-Shirt / Sweatshirt), & quantity. **Please send £3.50 for demo print.**

**PRINTS**

A4 = (approx. the size of this magazine) **£5.50**  
A3 = (approx. this magazine opened out) **£6.50**  
AO = £Ring Framed = £Ring  
The size of a bedroom wall or larger (Ring)  
Encapsulated in clear plastic  
(looks great) = **£2.00 extra**

**T-SHIRTS**

Child = **£13.99** (2-4, 5-6, 7-8, 9-11)  
Adult = **£15.99** (S, M, L, XL)

**SWEATSHIRTS**

Child = **£15.99** (2-4, 5-6, 7-8, 9-11)  
Adult = **£19.99** (S, M, L, XL)

Please add £1.50 postage & packaging

**Prices are subject to change without notice. All cheques/ postal orders made payable to The Silicon Picture Company**

The Big Alternative Scroller = **£45.00** Imagine = **£190**  
Real 3D Beginners = **£120.85** Real 3D Pro = **£340**  
Wordworth (Workbench 2.0 like performance even on a 1.3 machine) = **£129.99**

**081 - 556 - 7607**

CALL 8am - 8pm

22 Lascelles Close, Leytonstone, London, E11 4QE  
**Personal callers by appointment only**



# AMIGA REPAIRS JUST £44.95 inc.



- ★ Commodore registered
- ★ Over 10 years experience with Commodore computers
- ★ 20 qualified technician engineers at your disposal
- ★ We will undertake to repair your Amiga 500 computer for just £44.95 including parts, labour, VAT and post & packing
- ★ Most computers should be repaired within 24 hours of booking in.
- ★ Prices include full service check, overhaul, soak-test and replacement of power supply unit if necessary
- ★ Repairs to keyboard and disk drive also included (£25 extra if these units are unrepairable and require complete replacements)
- ★ All repairs covered by a 90 day warranty



**Upgrade your Amiga from 512K to 1Mb of memory for just £25.00  
SPECIAL EXCLUSIVE OFFER:**

**If you submit your computer to ourselves for repair, enclosing this advert along with just an additional £25, we will supply and fit a 512K memory expansion at no extra cost.**

*How to take advantage of this exceptional offer: simply send or hand deliver your machine to the workshop address detailed right, enclosing payment and this advert and we will do the rest. (If possible please include a daytime telephone number and fault description).*

*\* If you require 24 hour courier to your door, please add £5 else your computer will be sent back by contract parcel post.*

**WTS ELECTRONICS LTD**  
STUDIO MASTER HOUSE  
CHAUL END LANE  
LUTON, BEDS, LU4 8EZ  
Telephone (0582) 491949 - (4 lines)

WTS reserve the right to refuse machines that in our opinion are beyond reasonable repair

around, we've also had some real classics this year. Lemmings and The Secret of Monkey Island are just two good examples.

Remember, we don't review games just for our own personal enjoyment: Screen Play is there to help you pick out the real goodies and avoid the real losers. And I'd really like to hear anyone's views on the current state of games.

## FAIR DEAL WANTED

**PRIZE** Some months ago I sent a game back to a software house because it had stopped working after a month's play. I pointed out that I could not return the game to the place it was bought as it had been a present, and I sent only the disk, not the box or instruction booklet, to save on postage. Since then I have heard nothing at all.

This is in sharp contrast to Gremlin Graphics, who promptly exchanged a disk and apologised into the bargain, and that was from a budget compilation!

If software houses make disks that cannot be backed up, I do think they should be prepared to change disks that develop faults. After all, the first thing that we are told to do by Commodore is to back everything up!

DENIS GREGORY, RICHMOND

*I don't know if you're aware, but there's been a definite increase lately in the pressure exerted by the software houses to oppose such things as copying devices. While we agree that piracy is a problem which we all share – the more of it goes on, the more we all have to pay for our software – we also believe that we buy data, not disks, and that we have the right to continue enjoying a game even if not the magnetic medium on which it is stored packs up. If we can't back the disks up because they are copy-protected, then we must be entitled to free replacements.*

*If you do have a disk that you can't back up and it stops working, then you should send it back to the software house keeping the box and the manual, just like Denis here very sensibly did.*

*Last but by no means least, I would be very pleased to hear from anyone who has any praise for or complaints about the service provided by particular software houses. We may start up an awards system for the best and the worst software houses!*

## ARCHIPELAGOLOGY!

Oh dear! It seems I owe you an apology for suggesting that you were peddling dud games on the Coverdisk. I must write out a hundred times "If all else fails, please read the instructions..."

TD BURGE, BANSTEAD

*Apology accepted, and you needn't do the lines. Naturally we don't expect you to have to guess how to use the Coverdisk, so we do our best to give you clear instructions: but it does help if you read them!*

*And we wouldn't dream of putting dud games on the Coverdisk, so in case you are one of the few people whose disk refuses to work every month, please be patient. I know there's always a few disks that seem to take an age to be returned but we're streamlining the system now. If you can bear in mind that we now duplicate 160,000 disks every month and that a few are bound to go wrong, we'd be grateful.*

## THE END

You asked for interesting endings to games. Well, after what seemed to be an eternity of playing my time

away, night after night and nearly all of my spare time, to the annoyance of my wife, I eventually got to the end of Cinemaware's Wings. It was such a feat to achieve: it was also quite a pleasure to see that so much effort had been put into it. Smashing stuff! By the way, the secret to finishing Wings is saving a lot.

ANDY GUNN, LINTHORPE

*YES, BUT WHAT HAPPENS? Believe it or not, I haven't actually finished every game played, which is why I'm so curious about the end game sequences. I want to know what happens! Come on, you readers, send in the details of your favourites! There may be a prize in it...*

## US BONDS

I had the joy of discovering your magazine on a recent business trip. I am not sure how you can pack so much, including one or two disks and shipping from Britain, into a magazine that retails in the States for about 30% less than our domestic magazines with disks. It was a delight to once again read an Amiga magazine that addresses all types of users and is not totally filled with video usage!

I have two questions: how can I subscribe over here (I may never see another issue otherwise) and why (my son asks) do you call your Teenage Mutant Ninja Turtles game 'Hero Turtles'?

BARLOW SOPER, RUSTON, LOUISIANA

*Very pleased to hear you like it: I reckon US magazines with disks overcharge. Of course the problem we have occasionally is that our magazine is produced mainly for European PAL users and some programs may not work on the American NTSC system. Fortunately, this doesn't seem to be too much of a problem with most Coverdisk software.*

*Simply look at our Subscription pages for details: this issue's are on Pages 178-9. Overseas subs go by air mail, so they are a shade expensive. I'm afraid, and I believe you should pay with an International Money Order if possible. As for the Turtles: well, it seems that when the TV cartoon was imported by the BBC they insisted on the name being changed because 'Ninja' had excessively violent connotations. The TV version over here even has a 'Hero Turtles' version of the theme song. The Hero tag has stuck to some licences, including the computer game.*

## YOU LITTLE MONKEY!

**PRIZE** My parents bought me The Secret of Monkey Island because I had chicken pox, but they wouldn't allow me to see the guide you show in Issue 24 until I'd nearly finished the first part.

Now I find once I've finished the first part that you've got two things missing.

The first one is that the Voodoo shop is not just as far as the chest with the chicken. If you go to the edge of the screen after you've completed the three trials, you will find that there is a voodoo lady and she will tell you about your journey ahead and about the only thing that can destroy Captain LeChuck.

The second thing is that it's much easier to find the swordmaster by following the shopkeeper after you ask him to show you the way to the swordmaster. As soon as he has left, go out of the door and you will see him going through the archway. And if you follow him he will show you a much quicker route through the forest.

JOHN WALLEY, AGED 9, SWANSEA

PS Dictated by John and typed by Mum on her PC.

The whole family think that this game is absolutely brilliant – it even repays playing over and over again. And any game I can do better than my children just has to be brilliant...

*Well, John, of course being absolutely mad on Monkey Island, we just had to agree with you and your mum and I think you deserve a T shirt. Just tell your mum she shouldn't be using a PC, would you?*

## THE ICEMAN COMETH...

Here in Iceland, many computer freaks fell into the PC pit, but a few of us sensible ones have Amigas. We've formed a club called Promo, counting 53 members at the moment. As the entire nation only consists of 260,000 humans this should be considered remarkable!

FREYR NJARDVIK, REYKJAVIK

*Only 260,000 humans, eh? So what are all the non-humans? If there's anyone else out there in the wide world outside the UK, please write in. We'd love to hear from you and, if you live in Florida, we'd like to come and stay for a couple of weeks...*

## SCARLET TREE FISH

There is a chicken inside my Amiga and it can speak "English", and without fail every Tuesday it says "I am going to get you on your nineteenth birthday". It knows my father's name and what kind of cigarettes my grandmother smokes.

Sometimes I hear the voice of Adolf Hitler when I am on the toilet. I am scared as I will be nineteen soon. Am I going mad, or does this happen to everyone who is learning Assembly language?

RODGER

*The philosopher Wittgenstein was walking down a corridor one day with a friend. He turned to his friend and said, "Tell me, why do people always say it was natural for primitive man to assume the sun went round the earth?" "Because it looked that way" answered the friend. "But what would it have looked like," responded Wittgenstein, "if it had looked as if the earth went round the sun?"*

## CDTV QUESTION

I have been greatly impressed by the potential of the CDTV, and after reading your feature I am very tempted to buy my own 'black magic box'. However, I feel this may be a rash move with the imminent arrival of the Amiga CD-ROM unit. I already have an A500 expanded to 1 Meg and I would save a considerable sum by purchasing the CD-ROM instead.

Could you please tell me the advantages of buying the CDTV over the CD-ROM unit? I was also wondering about the reactions of the people who have already bought a CDTV... are they still glad they did?

JULIE-ANNE SPARKES, WIMBLEDON CHASE

*I've been wondering about people who've bought a CDTV too: please do write in and tell me what you think about it, if you have got one. Now, as far as I am aware, the CDTV has only two advantages over the Amiga-plus-CD-ROM combination, and that's its looks and a MIDI interface. The CD-ROM drive for the Amiga should – and I emphasise the should, because we don't yet know – should enable infra-red remote control to be used and play Hi Fi CDs back. This would actually leave the Amiga massive advantages: you already have a keyboard, a disk drive and standard joystick ports (some CDTV games, like Xenon 2, do*



not perform well under infra-red control and need the wire-connected controller). How much of the 'should do' becomes 'does' in the CD-ROM drive remains to be seen. I'd certainly hang on to your Amiga.

CDTV REACTION

"So remember: the future of the CDTV depends on you..." you said at the end of your CDTV feature in the July issue. A big invite to comment, I thought.

I'm looking forward to multimedia and all that. I'm not a computer buff - I don't even own one, can't even operate one - but when I was only halfway through your piece on the Commodore CDTV I was just busting to know where I would have to phone the next day to buy one. I could hardly contain my excitement at the prospect of having one - and so reasonable a price too!

What a let-down it was, then, to read the 4th para on the picture on p34: "not a CD player for the Hi Fi buff..." So it's useless! well, that's my view anyway. make it Hi Fi and for, say, £650 and they'll sell very well, but like it is there'll be few takers.

MAURICE SAWYER, BEACONSFIELD

I'm fascinated that you are reading Amiga Format if you're not a computer buff anyway! But that actually makes your comments all the more interesting, because you, more than us Amiga fans, are the sort of person Commodore would like to see buying the CDTV.

About the Hi Fi thing: what I actually meant is that the quality of the CDTV's CD audio is not up there with the top CD players: it's still a 16 times oversampling system that's in there with the sort of stuff most of us would buy. It's not great, it's not awful.

But what surprises me most is that this is one of only four letters we've had on the subject of the CDTV

- and two of those were from the same person! Don't you lot care at all? Are you looking forward to paying CD software on your Amiga, or not? Come on, let's hear your views.

SMART COOKIE

I would like to make a suggestion to all new Amiga owners: check that all the ports on your Amiga are working. When I'd saved enough money to buy my printer, I was like a kid in a sweet shop with a tanner to spend. Imagine my disappointment when I got it home, read the instructions twice, plugged it all in and... nothing but garbage!

Back to the shop I went, grabbed the shop assistant politely by the throat and said in a most polite voice that it didn't work. the printer was checked and found to be in working order... could I bring my Amiga in?

I had to have a new motherboard and parallel port. Luckily for me it was just six weeks before the warranty ran out. If I had bought the printer six weeks later I would have had all the expense of the repair, even though the port might not have been working when I bought the machine.

GORDON SUTHERLAND, LEICESTER

That's a very good point, I don't believe it's one I've heard before. Ten Brownie points to you, old chap!

MIXED METAPHORMOTOSIS

Just recently, Commodore have received criticism from Atari and Sam Tramiel in particular about the CDTV launch (I refer to the interview in New Computer Express). Also Atari are launching new consoles and updating their somewhat old ST. Isn't it

about time Commodore stopped treading the minefield in the dark and got their finger out?

JOHN BURGIN, LINCOLN

Err... got their finger out of what?

GET REAL!

You have got yourself into the ridiculous situation where you are distributing the August edition in the first week in July! Isn't it time you got back in the real world? I suggest you call the next issue 'August extra' and carry on from there...

CAPT ERIC STARLING, W KILBRIDE

Magazines always publish their August editions in July: it's a tradition dating. I'm told, back to magazines that would carry diaries of events for the next month. anyway, it's all right for you... you don't have to work on the September edition, the one that comes out in August, during July... it gets very confusing. What day is it?

GOOD QUESTION!

Call me stupid, which you probably will, but why have the computer firm called Hart Micro always advertised upside down for as long as I can remember? Is it a gimmick to get people to look at their ad, or are the AF printing facilities not as hot as they used to be?

TIM MEADER, NEW ASH GREEN

The first, believe it or not. We reckon this particular gimmick is getting a bit tired, but it must work for the boys at Hart otherwise they'd stop doing it pretty quickly, wouldn't they? Certainly it just got them some free publicity...

WANTED! YOUR HONEST OPINION OF AMIGA FORMAT - SO WE CAN MAKE IT EVEN BETTER!

This questionnaire helps us monitor what you, our readers, think of AMIGA FORMAT and keep it tailored to your wishes. Please don't pass up this opportunity to influence the future of your magazine. We really do want to know your honest views!

1. Which equipment do you own?

- A500, A1000, A1500, A/B2000, Extra RAM, Hard drive, Atari ST, Commodore C64 or C128, Sega console, Nintendo console, PC, Amstrad CPC, Spectrum, Other

2. How do you rate AMIGA FORMAT in terms of value for money?

- Excellent value, Good value, Reasonable value, Poor value, Rip-off

3. How much does the cover of this issue appeal to you?...../10

4. How much does this issue appeal to you overall?...../10

5. How does it compare with previous issues you've seen?

- Much better, Slightly better, The same standard

- Slightly worse, Much worse

6. Please rate out of ten this and any other computer magazines you read regularly:

AMIGA FORMAT ...../10

7. What is it you like most; and then least about this issue?

I most like .....
And I least like .....

You don't need a stamp. Simply return to:- Reader Survey, AMIGA FORMAT, Future Publishing Freepost, Avon, Bath BA1 1XY



**YOUR ONE STOP SHOP**  
**MORE SOFTWARE THAN YOU CAN HANDLE!**  
**MORE HARDWARE THAN YOU CAN USE!**

# AMIGA MEGAPACK

**THE 1 MEG AMIGA pack**

Exclusive to **Software Superstore**

**Limited Offer**

	<b>WORTH</b>
◆ Amiga A500 <i>(Inc workbench, mouse, PSU &amp; manuals)</i>	399.99
◆ TV Modulator	29.99
◆ Astra Pack Software	224.50
◆ 1 Meg Memory upgrade + clock	39.99
◆ Drive Head Cleaner	4.99
◆ De-Luxe Dust Cover	4.99
◆ Mouse mat	3.99
◆ Lockable disk box (80)	9.99
◆ Zip Stik Auto fire Joystick	14.99
◆ 10 disks full of Amazing 1 meg Demos	20.00
◆ Free Holiday accommodation	

**TOTAL £753.42**

**OUR PRICE £399.99** Add £10 for Courier delivery

**FREE with 1Meg AMIGA**

**Amazing ASTRA PACK**  
**Ten superb games - all received rave reviews - from 70% - 95%**

◆ Datastorm	£19.95
◆ Dungeon Quest	£24.95
◆ E-Motion	£19.95
◆ Grand Monster Slam	£19.95
◆ Kid Gloves	£24.95
◆ Powerplay	£19.95
◆ RVF Honda	£24.95
◆ Shufflepuck Cafe	£19.95
◆ Soccer	£24.95
◆ Tower of Babel	£24.95

**TOTAL RETAIL VALUE £224.50**

**NEW**

## CUMANA AMIGA DRIVES

**the BEST NAME in Disk Drives**

- **Legendary Quality**
  - **Great Styling**
  - **Total Compatibility**
  - **Fully Guaranteed**
  - **Outstanding Spec**
- NOW Only £64.99**  
 Carriage & insurance £2.00

## MEGADRIVE

**+ Mickey Mouse + World Cup Italia 90**  
**+ Joypad + Japadaptor**

**UK Version**

**£179.99**  
 Carriage FREE



## AMIGA 512K MEMORY UPGRADE

- \* Brings your Amiga up to 1 Meg in seconds.
- \* Easy to fit - DOES NOT INVALIDATE YOUR GUARANTEE.
- \* RELIABLE, fast, high quality chips on a robust through plated P.C.B. Do not confuse with cheaper, inferior products.
- \* Disable switch

**ONLY £34.99** +£2 Postage

**OR WITH CLOCK/CALENDAR**

**ONLY £39.99** +£2 Postage

### PRINTERS

All Printers Carriage FREE

**star LC10**

"Best Buy" budget printer.

**Only £169.99**

**star LC24 - 200**

**Only £259.99**

### NEW COLOUR PRINTERS

**star LC200**

**Only £219.99**

**star LC24 - 200**

**Only £329.99**

**EVERYTHING you could possibly need for your AMIGA**

### Blank Disks

We sell only the highest quality blank media 100% certified and made in Japan. Each disk is guaranteed for life.

Unbranded BULK PRICES

50 .....	£19.99
100 .....	£37.99
10 with box (40) .....	£9.99
10 with box (80) .....	£12.99

Add £2 postage per order

# SOFTWARE SUPERSTORE

#### STOKE-ON-TRENT

11 MARKET SQUARE ARCADE,  
 HANLEY, STOKE ON TRENT  
 MANAGER: ADRIAN  
 TEL: 0782 268620  
 OPEN 6 DAYS

#### ST HELENS

27 BALDWIN STREET,  
 MANAGER: ANDY  
 TEL: 0744 27941  
 CLOSED THURSDAY

#### STOCKPORT

6 MEALHOUSE BROW,  
 (OFF LITTLE UNDERBANK),  
 MANAGER: RAY  
 TEL: 061 480 2693  
 OPEN 6 DAYS

#### WARRINGTON

THE COURTYARD  
 50 HORSEMARKET ST  
 TEL: 0925 232047  
 MANAGER: ADRIAN  
 OPEN 6 DAYS

#### BOLTON

SHIPGATES  
 SHOPPING CENTRE  
 MANAGER: IAN  
 TEL: 0204 365851  
 OPEN 6 DAYS

**Order HOTLINE (0782)204639**

**MAIL ORDER**

Unit 7a Oldham St  
 Hanley  
 Stoke on Trent  
 ST1 3EY

VISA

Access

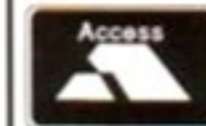



# ADVERTISER'S INDEX

1st Choice (LEEDS) .....180	Diamond.....94-99	Merlin Express.....16	Seasoft .....172
16 Bit Centre .....144	Digicom .....50-51	MG Computer Services ....192	Selec .....195
ABS .....181	Digita International .....35	Microdeal.....102	Sidewise .....189
Activision ....IBC, 11, 28-29, 67	Domark.....63	Micromail .....70	SMD .....192
Ad Energy.....199	Dowling .....142-143	Microprose.....45	Soft Centre .....192
Akore .....167	Ed Lib .....160	Miditech .....168	Soft Exchange .....195
Amiga Mouse .....160	Electronic Arts .....6-7	NBS .....152	Soft Logik .....47
Amiganuts .....165	Evesham Micros .....111-113	New Dimensions .....168	Software Superstore.....200
Anglia PD .....160	FMG .....78	Newtek.....OBC	Special Reserve .....14-15
ARK .....199	Gasteiner.....100	NRG .....169	Spectra Video .....73
AS DG .....80-81	Get The Most Out Of Your	Ocean.....IFC-3, 86, 105, 107	Strategic Plus .....189
Axe Direct.....69	Amiga .....171	Off the Wall.....154	Studio 101 .....172
BCS .....175	Gold Disk.....13	Office Choice.....154	Supply Solutions.....175
Bitcon .....181	Hammersoft.....181	Original Media .....90	Surface UK .....60
Blitterchips.....163	Harwoods .....38-41, 118	PAS Enterprises .....168	The Army.....74-75
Byteback .....156-157	Hobbyte .....84	PCS .....169	The Silicon Picture Co.....196
C & N Computers .....155	Home Based Business .....168	PD Direct .....164	Trilogic.....194-195
Capitol North .....192	JRNH Media .....190	PD Soft .....161	Tronsoft .....192
Computermates .....110	Keyphase .....172	PDom PD Amiga .....122	Turbosoft .....150-151
Computerwise Brighton ....175	KG Leisure .....148	PLC .....199	Universal Overnight Dist....146
Connect International .....139	Kosmos .....193	Post Haste.....136	US Gold.....20-21
Core Design .....52	Lazersoft.....177	Precision Software .....30	Vally PD.....165
Cortex.....185, 188	LCL.....189	Premier Mail Order .....184	Virgo Developments .....138
Crazy Joes .....158	Load Crest.....154	Protar.....42	Voiceline .....92
Data Disk.....190	Manor Court Supplies.....201	Proton.....138	Vortex .....48
Datagem.....172	Marcam .....139	RC Simulations.....189	We Serve.....190
Dataplex .....175	Matrix.....181	Richards Developments ....196	Wizard .....181
Datel.....126-131	MD Office Supplies....109, 170	Riverdene PDL .....154	WTS .....193, 196
Dem-X .....169	Mechanix .....189	Sagittarian PD .....168	Zepplin Games .....57
Dial-A-Disk .....193	Media Direct .....133-135	Screen Play - The Book....119	

## NEW LOW PRICES BRANDED DISKS AT BULK PRICES BENCHMARK BRAND

ALL 3 1/2" DISKS COME WITH LABELS. ALL 5 1/4" DISKS COME WITH LABELS WRITE PROTECTS AND SLEEVES

Disk Type	Qty	25	50	100	200	500	1000
3 1/2" DS/DD 1Mb	£	17.00	29.00	41.00	75.00	163.00	309.00
3 1/2" DS/HD 2Mb	£	33.60	61.00	67.00	132.00	320.00	630.00
5 1/4" DS/DD 96/48 TPI	£	11.00	18.00	28.00	51.00	122.00	225.00
5 1/4" DS/HD 1.6Mb	£	18.00	31.50	52.50	99.00	228.00	394.00

ALL OUR DISKS ARE 100% CERTIFIED GUARANTEED ERROR FREE

ALL BENCHMARK 3 1/2" DS/DD DISKS ARE NOW MANUFACTURED  
BY THE WORLD'S LEADING MAKER.

### DISK STORAGE BOXES LOCKABLE

3 1/2" 50 capacity.....	£3.70
3 1/2" 100 capacity.....	£4.70
5 1/4" 100 capacity.....	£4.70
5 1/4" 200 capacity (stackable) .....	£13.50

THESE PRICES ONLY IF BOUGHT WITH DISKS

**M  
C  
S**

ALL PRICES INCLUDE VAT & P&P UK ORDERS ONLY

Cheques and  
Postal Orders to:

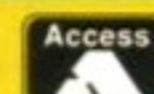
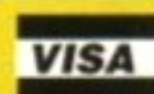

24 HOUR ORDERLINE 0597 87784

### Manor Court Supplies Ltd

Telephone: 0597 87 792 Fax No: 0597 87 416  
Dept AF9, Glen Celyn House, Penybont, Llandrindod Wells, Powys, LD1 5SY

EDUCATION AND GOVERNMENT ORDERS WELCOME

UNBRANDED DISKS AT SAME PRICES

Summer: where the hell is it? It's now July 23 and there's still no decent weather. Here's hoping it's got a bit better by the time you read this...

# Random Sample **THEME**

An exuberance of curmudgeonliness from the month in which AF 26 was stapled to pieces of bromide...



Keep an eye

out for the Circus Archaos, now summer touring in the UK once again. It's Mad Max meets Chipperfield's with plenty of trashed cars!

## SOUNDBYTES

"There's no damage to the car: except, of course, to the car itself." Murray Walker notches up another classic during the British Grand Prix, 14 July.

"We put together 25,000 Home Entertainment packs for Christmas. They included the C64 computer, games, a personal stereo and a guitar synthesiser, all for £199. It was a disaster: we sold about 7,000. Fortunately, when the Berlin wall came down the first thing they wanted to buy was personal stereos, so we managed to get rid of them. But I was left with about 18,000 guitar synthesisers..."

Steve Franklin, Managing Director of Commodore UK, talking about his greatest mistakes in the *Independent on Sunday*, 21 July.

### WHO SAID THAT? 4

The quote on the Contents page of Issue 24, "The future is, and always has been, an interesting place", is from Andy Smith, one-time Reviews Editor of *Amiga Format*, in his review of the game *Interphase* in Issue 4. Well waddy know, eh? There was only one single person who got it right: Lisa O'Connor of Trowbridge. And she wins the prize.

### WHO SAID THAT? 6

To win a special *Amiga Format* T shirt, identify the quotation on the Contents pages and send an accurate, amusing or imaginative description of where it comes from to Who Said That? 6, *Amiga Format* at our Bath address before September 13.

### SPOT THE SHOT 3

It was a tricky one, this: but the shot was a small portion of a wall from *Eye of the Beholder!* Still, plenty of you got it right despite the trickiness of the question: and the lucky winner we picked out of the cat's hat is Daniel Meeuws of Boars Hill, Oxford. Well done, and a special *Amiga Format* T shirt is on the way.

### TOP EVENT

The *Amiga Format* World of Commodore Show! We're working our little bottoms off preparing some special surprises, and we look forward to seeing you all in person at Earl's Court II in November!

### WORDWORTH WINNERS!

The answers to the ten questions are a bit involved to print here, so we'll just name the eight lucky people who won a free copy of *Digitia's* new word processor. They are: John Prior, High Wycombe: SR Price, Rhuddlan: David Whitaker, Darlington: Jim Campey, Brentford: Julie Mundy, Thetford: Steve Taylor, East Dereham: RT Balderson, Uckfield: S Gulliver, Southampton.

### THE AMIGA FORMAT NON-DRAUGHT BEER SURVEY

We asked ourselves what our favourite canned or bottled beers are. The sample of people interviewed is in no way representative of the country at large and this information should not be used except for the purposes of bribery and corruption. All candidates are from demographic groupings A, B or C1 except Frankie who is in dermatological classification D-minus.

Marcus: Zipfer (Austrian lager, bottled) Pat: Newcastle Brown Ale (Geordie, bottled) Paul: Kirin (Japanese lager, bottled) Frankie: Peroni Nastro Azzuro (Italian beer, bottled) Damien: Wadworth's 6X (canned) Gary: Budweiser (Czech lager, bottled - not the US stuff) Trenton: Draught Guinness (canned) Maff: Schlitz (Milwaukee bottled beer).

### SPOT THE SHOT 5



Win a special limited edition *Amiga Format* T shirt by identifying the game that this is a small portion of and sending the answer on a postcard to Spot the Shot 5, *Amiga Format* at our Competition address before September 13.



"ORIGINAL GANGSTER"  
GREGORIAN CHANTS  
"LOADA RUBBISH, REALLY"

AMIGA FORMAT

202

SEPTEMBER 1991

## 'Your guarantee of value'

This magazine comes from Future Publishing, a company founded just six years ago, but which now sells more computer magazines than any other publisher in Britain. We offer:

**Better advice.** Our titles are packed with tips, suggestions and explanatory features, written by the best in the business.

**Stronger reviews.** We have a cast-iron policy of editorial independence, and our reviews give clear buying recommendations.

**Clearer design.** You need solid information fast. So our designers highlight key elements by using charts, diagrams, summary boxes, annotated photographs, etc.

**Greater relevance.** At Future, editors operate under two golden rules:

- Understand your readers' needs.
- Satisfy them.
- Then go down the pub.

**More reader interaction.** We draw strongly on readers' contributions, resulting in the liveliest letters pages and the best reader tips. Buying one of our magazines is like joining a nationwide user group.

**Better value for money.** More pages, better quality: magazines you can trust.



Home of Britain's finest computer magazines.

Amiga Format • ST Format  
Amiga Power • Amiga Shopper  
PC Answers • PC Plus • 8000 Plus  
Amstrad Action • Your Sinclair • Sega Power  
New Computer Express • Commodore Format

## The Team ...

**EDITOR** Damien Noonan **ART EDITOR** Marcus 'Dr' Dyson  
**SCREENPLAY EDITOR** Trenton Webb **TECHNICAL EDITOR** Pat McDonald **STAFF WRITER** Maff Evans **PRODUCTION EDITOR** Gary Lord **DESIGNER** Frank Bartucca **REVIEWS EDITOR** Paul Lyons **CONSULTANT EDITORS** Jon Bates (Music), Brian Larkman (Graphics) **CONTRIBUTORS** James Leach, Andy Hutchinson, Frank O'Connor, Neil Jackson, Mark Smiddy, Jason Holborn **ADVERTISING MANAGER** Jennie Evans **SENIOR SALES EXEC** Duncan Ferguson **AD SALES EXEC** Jackie Garford **AD PRODUCTION** Fiona Milne **PUBLISHER** Greg Ingham **PROMOTIONS MANAGER** Michele Harris **AD SERVICES** Tam Ward **WE CREATED AMIGA FORMAT and they... well, you remember!**

PHOTOGRAPHY Ashton James, Bradford-upon-Avon COLOUR ORIGINATORS Swift Graphics Ltd, Southampton, PRINTERS Riverside Press Ltd, St Ives PLC, Gillingham NEWS TRADE DISTRIBUTION UK Future Publishing 0225 442244 NEWS TRADE DISTRIBUTION OVERSEAS: MMC Ltd 0483 211222 CIRCULATION DIRECTOR Sue Hartley 0225 442244.

Dear Newsagent,

Please reserve \_\_\_\_\_ copy/copies of *Amiga Format*:

*Amiga Format* Issue 27, October 1991 - on sale September 12

Name .....

Address .....

.....

.....

**To the Newsagent:** *Amiga Format* is published and distributed by Future Publishing and is available from your wholesaler. Send back these coupons for entry in a free prize draw to: Kate Hodges, Future Publishing, 30 Monmouth Street, BATH BA1 2BW. Remember to include your shop, name and address.

## BE SAFE: RESERVE YOUR COPY!

*Amiga Format* always sells out. Wherever you live, you may already have been through the awful experience of trekking round all the newsagents in town without being able to get your hands on a copy. We just can't keep up with demand: we are, after all, far and away Britain's biggest-selling Amiga magazine.

And of course Issue 27 is likely to sell out even more quickly than the magazine normally does. It'll be carrying a special report on 24-bit True Colour, including the details of the latest high-end kit and a review of the first affordable 24-bit system.

The best way to make sure you get your sticky mitts on this exciting issue is to cut out or photocopy the coupon on the right, fill it in, take it down to your newsagent and make sure he saves you a copy. Don't forget!

## SUBSCRIBE AND GET A SPECIAL GIFT!

THERE'S ONE way you can be sure to get your copy of the magazine fresh off the presses every month, and that's to get a subscription to *Amiga Format* for the next year.

THINK ABOUT IT: twelve issues of *Amiga Format* delivered straight to your door, a free special extra subscriber's bonus of a game or some serious software, plus the chance to buy special offers that only subscribers can have! You know it makes sense!

Turn to Page 178 NOW!



# DEUTEROS

Actual 16 Bit Screens

## THE NEXT MILLENIUM

It is the end of the 31st Century. Nearly one thousand years ago man colonised the moon, and from there created a range of human mutations which were left to develop other planets. At the same time, life on earth was destroyed by a cataclysmic climatic change.

Now the mutant races are at war with each other, and man has returned to Earth, rebuilt civilisation, and forgotten about past adventures.

Deep in Earth City, plans have been made to explore space again. The race has started to develop Earth's resources, to research new technology, to build for future adventures.

You must control the training, research, resources, production and stores of Earth City in a complex strategic battle to maximise the planet's supplies. You must construct and pilot the hi-tech space shuttles and ships needed for mankind to venture out into the furthest reaches of the war-torn solar system. Operation Deuteros has begun.

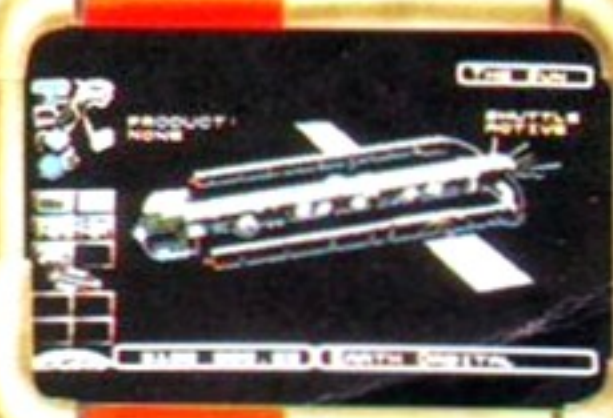

Available in August on Amiga & Atari ST

# ACTIVISION

# D I G I • V I E W G O L D

4096 Colours in High Resolution...is just the beginning



W

ith the all new Digi-View 4.0 software you can do the one thing most people thought was impossible—digitize and display all 4096 colours

**in high resolution!** We call this revolutionary new graphics mode Dynamic HiRes. Amiga Format magazine calls it "breathtaking, easily the best images ever seen on an Amiga screen." But that's just the start of what makes Digi-View 4.0 a breakthrough. Other new features include: Dynamic HAM (fringe free HAM), Noise Reduction (for the sharpest images ever), ARexx support, super bitmap digitizing, 24 bit colour support and dozens of other new features making Digi-View Gold the hottest Amiga graphics product ever.

And it's still just as easy to use. Simply focus your video camera on any object or picture, and in seconds Digi-View Gold turns it into Amiga graphics that glow with vibrant colour and stunning clarity. Whether you are creating graphics for desktop publishing, presentations, video, or just for fun, Digi-View Gold gives you dazzling images with amazing simplicity.

These images were photographed directly from an Amiga 1080 monitor and show the new 4096 colour Dynamic HiRes mode available only with NewTek's Digi-View 4.0

## Digi-View 4.0 and Digi-Paint 3 Become One

with the ultimate link between digitizer and paint program. With Digi-View 4.0's Digi-Port feature they can both share the same screen so that touching-up your digitized images is easier than ever. Transfer 768x592, 4096 colour super bitmaps from Digi-View 4.0 to Digi-Paint 3 with a simple menu command, make changes such as combining images or adding titles, and redisplay them as Dynamic HiRes or other resolution images.

### Only Digi-View Gold:

- Digitizes in all Amiga resolution modes from 320x256 up to 768x592 (full HiRes overscan)
- Includes powerful Digi-Paint 1 software for retouching digitized images or creating original artwork
- Uses 2 to 4096 colours (including halfbrite)
- Has exclusive Dynamic modes for 4096 colours in HiRes
- Digitizes in 21 bits per pixel (2.1 million colours) for the highest quality images possible
- Has advanced dithering routines that give an apparent 100,000 colours on screen simultaneously
- Has a special line art mode for desktop publishing
- Comes with an icon driven slideshow program for presentations using both IFF and Dynamic images
- Has complete software control of colour saturation, brightness, sharpness, hue, resolution, and palette
- Digitizes in full overscan with no borders for use with video genlocks
- Offers an unprecedented lifetime warranty

If you want the best graphics possible for your Amiga, then get the best selling video digitizer of all time: Digi-View Gold.

**Only £149.95** For a NewTek authorized dealer  
Inc. VAT near you contact HB Marketing,  
Ltd. at 0753 686000

Now includes  
Digi-Paint 1

**NEWTek**  
INCORPORATED

\*Requires standard gender changer for use with Amiga 1000. Dynamic HiRes requires 2 megs of RAM. Digi-View Gold is a trademark of NewTek, Inc.

